

# TRAFFIC ACCOMMODATION IN WORK ZONES 2018

Date of Issue: December 2018

Second Edition

© Copyright, 2018 Government of Alberta

The Crown in right of the Province of Alberta, as represented by the Minister of Alberta Transportation. Purchasers of this document in hard copy hereby given permission to reproduce all or portion of this document without modification. If changes are made to any of the drawings, it should be made clear that the drawings have been modified and all appropriate acceptances obtained before the modified drawings are used on a public roadway.

Delivery Services Division  
Alberta Transportation



## ACKNOWLEDGMENTS

Guidance and direction for the development of this manual were provided by the Traffic Accommodation Strategy Committee, which was comprised of the following individuals:

Mike Damberger (Executive Sponsor), Alberta Transportation  
Allen Rau (Chairperson), Alberta Transportation  
Elena Yin, Alberta Transportation  
Steve Lai, Alberta Transportation  
Anjita Parajuli, Alberta Transportation  
Dennis Adamkewicz, Alberta Transportation  
Rodge Rodrigue, Alberta Transportation  
Hal Cook, Alberta Transportation  
Rommel Directo, Alberta Transportation  
Estella Petzold, Alberta Transportation  
Nabila Chatur, Alberta Transportation  
Richard Chow, Alberta Transportation  
Fred Greenhough, Al-Terra, Consulting Engineers of Alberta  
Dan Dmytryshyn, CIMA+, Consulting Engineers of Alberta  
Leanne Binetruy, Consulting Engineers of Alberta  
Jolanta Wandzel-Mrugala, Scheffer Andrew, Consulting Engineers of Alberta  
Justin Moser, Ledcor, Alberta Roadbuilders and Heavy Construction Association  
Don Melnychuk, Border Paving, Alberta Roadbuilders and Heavy Construction Association  
Gary Brooks, Carmacks, Alberta Roadbuilders and Heavy Construction Association  
Helen Brown, Volker Stevin, Alberta Roadbuilders and Heavy Construction Association  
Kemp Hart, Carmacks, Alberta Roadbuilders and Heavy Construction Association  
Mark Dubbelboer, Lafarge, Alberta Roadbuilders and Heavy Construction Association  
Michael Markowski, Graham Construction, Alberta Roadbuilders and Heavy Construction Association  
Robert Seguin, Volker Stevin, Alberta Roadbuilders and Heavy Construction Association  
Thorne Forrest, ATS  
Philip Wong, ATS

Special acknowledgement is extended to all representatives of AT, CEA, ACSA, and ARHCA who took an active role for the preparation of this manual, and who provided valuable comments and resolutions on issues.

December 2018

This page intentionally left blank

Table of Contents

**1. Introduction .....1**

**2. Definitions .....2**

**3. Primary Responsibilities .....3**

**4. Preparing the Traffic Accommodation Strategy (TAS).....8**

    4.1 General ..... 8

    4.2 Details for Traffic Accommodation Strategy ..... 9

    4.3 Establishing the Traffic Accommodation Strategy ..... 10

**5. General Work Zone Considerations .....10**

    5.1 General ..... 10

    5.2 Duration of Work ..... 11

    5.3 Detours ..... 11

    5.4 Accommodating Pedestrians and Cyclists..... 12

    5.5 Coordination of Activities ..... 12

    5.6 Flagpersons and Similar Traffic Control Methods ..... 12

        5.6.1 Flagperson Apparel and Equipment..... 12

        5.6.2 Automated Flagger Assistance Devices ..... 13

        5.6.3 Portable Traffic Signals..... 13

    5.7 The Clear Zone Concept in Work Zones ..... 14

**6. Speed Management .....15**

    6.1 Temporary Speed Reductions ..... 15

        6.1.1 Changes in Traffic Speed ..... 15

    6.2 Transitional Speed Reductions..... 17

**7. Traffic Control Devices .....17**

    7.1 General ..... 17

        7.1.1 Awareness and Identification ..... 17

        7.1.2 Protection..... 17

        7.1.3 Lane Delineation ..... 18

    7.2 Temporary Signing..... 18

    7.3 Sign Types and Sequences ..... 19

7.3.1 Temporary Warning Signs .....	19
7.3.2 Regulatory Signs .....	19
7.3.3 Information (Guide) Signs .....	19
<b>7.4 Sign Spacing .....</b>	<b>19</b>
<b>7.5 Size of Signs on Urban and Rural Highways .....</b>	<b>20</b>
<b>7.6 Installation of Temporary Signs .....</b>	<b>20</b>
<b>7.7 Double Fines in Work Zones.....</b>	<b>20</b>
<b>7.8 Sequential Arrow Boards and Variable Message Boards .....</b>	<b>21</b>
<b>7.9 Delineators.....</b>	<b>22</b>
<b>7.10 Tapers .....</b>	<b>22</b>
<b>7.11 Specialized Traffic Control Devices .....</b>	<b>23</b>
<b>7.12 Overhead Illumination and Flashers.....</b>	<b>23</b>
<b>7.13 Protective Barriers.....</b>	<b>23</b>
<b>7.14 Water Filled Barricades.....</b>	<b>24</b>
<b>8. Monitoring Traffic Accommodation .....</b>	<b>24</b>
8.1 General .....	24
8.2 Daily Inspections .....	24
8.3 Hours of Darkness Inspections .....	25
8.4 Compliance with Contract Specifications and Traffic Accommodation Strategy on Department Construction Contracts .....	25
<b>9. Standard Drawings for Urban Highways .....</b>	<b>27</b>

Appendix A: Standard Drawings for Traffic Control on Rural and Urban Highways

Appendix B: Work Zone Bulletins

Appendix C: Sign Schedule

Appendix D: Sample Forms

# 1. Introduction

The Traffic Accommodation Manual assists in determining the most appropriate combination of traffic controls required to provide a safe, well organized, and efficient flow of traffic through construction zones on provincial highways. The manual provides information and outlines minimum standards for traffic accommodation. It also identifies the primary roles and responsibilities of each party for public safety.

Alberta Transportation recognizes that several different groups are part of the successful implementation of this manual. Contractors, Consultants and the Department all need to understand and use this manual in coordination with all other relevant materials to achieve the proper set up of Work Zones across all provincial construction and highway maintenance projects.

Consistent application of this manual is important to avoid unpredictability of traffic and roadway conditions among highway users. The travelling public is relying on visual and physical cues to navigate safely through construction zones. Uniformity of traffic accommodation encourages compliance and reduces confusion. Increased compliance benefits construction workers by achieving a more controlled Work Area where traffic is moving through the Work Zone as it is designed.

When activities such as road/bridge work, utilities work, or materials testing and surveying are performed on or adjacent to public highways in Alberta, the person(s) performing the work must take steps to ensure the safety of road users and workers, and the reliable operation of the highway network.

Requirements in addition to those set out in this manual may be provided for in Alberta Transportation contracts, agreements, permits and authorizations. In the event of a conflict between the requirements in this manual regarding speed limits or traffic control devices and Alberta Transportation's contracts, agreements, permits or authorizations, the more stringent requirements will govern. In the event of a conflict regarding other matters, the requirements in Alberta Transportation's contracts, agreements, permits or authorizations will govern. General considerations for developing an effective Traffic Accommodation Strategy (TAS) makes up the majority of this manual along with information on when to use various Traffic Control Devices (TCDs) on Urban and Rural Highways. A series of drawings detailing minimum standards for temporary signing in typical Work Zones on provincial highways are included in Appendix A. In the case of non-typical Work Zones, site specific traffic control measures are required to address the unique aspects of the project.

Note that the section entitled "Compliance with Contract Specifications and Traffic Accommodation Strategy" relates to Alberta Transportation construction and maintenance projects. The process used to address incidents of non-compliance may differ for highway maintenance and utility work because of the duration and nature of those projects.

## 2. Definitions

For purposes of this manual, the following definitions apply:

Term	Description
<b>ASDT</b>	Average Summer Daily Traffic (Traffic volume for an ASDT shall include traffic travelling in both directions at a given point).
<b>Buffer Zone</b>	The area from the end of the transition area to the actual work area.
<b>Clear Zone</b>	The border area starting at the edge of the travel lane that should be clear of hazards and available for use by errant vehicles.
<b>Consultant</b>	The Consultant is an engineering company (or their representative) retained by the Department to undertake work for the Department.
<b>Contractor</b>	The Contractor is the person or company that has entered into a Construction or Maintenance Contract with the Department.
<b>Department</b>	Alberta Transportation. As of November 2016, the Department is to only be referenced as Alberta Transportation. No other form or abbreviation is acceptable.
<b>Department Representative</b>	The Department official who liaises with the Contractor, Consultant or Utility Company. On Department construction contracts, this person would typically be the "Project Sponsor". On Department maintenance contracts, this person would typically be the Maintenance Contract Inspector (MCI).  For Utility work, this person would typically be the Development Planning Technologist.
<b>Gazetted Highway Speed</b>	The legislated highway speed prior to construction.
<b>High Speed, High Volume Highways</b>	Highways on which the gazetted speed is greater than 60 km/hr and the ASDT exceeds 10,000 vehicles per day.
<b>Long Duration Projects</b>	Stationary work that requires a separate work area for longer than 24 hours or during nighttime hours.
<b>Low Speed, Low Volume Highways</b>	Highways on which the gazetted speed is 60 km/hr or less and the ASDT is 10,000 vehicles or less per day.

## Traffic Accommodation in Work Zones

Term	Description
<b>Mobile Operations</b>	Work that is performed while moving continuously, usually at low speeds, or intermittently, with periodic stops which do not exceed a few minutes in duration.
<b>Rural Highway</b>	Any highway under the jurisdiction of Alberta Transportation located outside the corporate boundaries of an urban municipality.
<b>Short Duration Projects</b>	Stationary work that requires a separate Work Area that is continuously attended by workers for more than 30 minutes within a single daylight period.
<b>Specifications</b>	The latest editions of Alberta Transportation's Standard Specifications for Highway Construction, Specifications for Bridge Construction or Highway Maintenance Specifications.
<b>Traffic Accommodation Strategy (TAS)</b>	Plans and written procedures detailing the traffic accommodation activities for any work within the highway right-of-way.
<b>Traffic Control Devices (TCDs)</b>	Temporary signing, traffic control signals, arrow boards, pavement markings, delineators, message boards, etc., used for traffic accommodation in the Work Zone.
<b>Urban Highway</b>	Any highway under the jurisdiction of Alberta Transportation located within the corporate boundaries of a municipality.
<b>Utility Company</b>	The person(s) installing, adjusting, maintaining or relocating a utility within the highway right-of-way.
<b>Very Short Duration Projects</b>	Work that occupies a fixed location for up to 30 minutes (including the time that it takes to setup and remove TCDs).
<b>Work Area</b>	The area or location of the actual traffic disruption or hazard. There may be several Work Areas within the Work Zone.
<b>Work Zone</b>	The area extending from the first advance warning sign to the last construction sign.

### 3. Primary Responsibilities

To ensure traffic accommodation is handled in a consistent, safe and effective manner, it is critical that all parties to Alberta Transportation's contracts, agreements, permits and authorizations carry out their respective responsibilities concerning traffic accommodation.



The primary responsibilities of the Contractor, Consultant, Utility Company, Municipality and the Department for traffic accommodation are as follows:

### **A. Contractor**

The following are the Contractor's primary responsibilities for traffic accommodation on Department highway/bridge construction and maintenance contracts.

On construction projects, any required submissions or reporting by the Contractor shall be directed to the Consultant. On maintenance projects, any required submissions or reporting by the Contractor shall be directed to the Department Representative.

- Develop a Traffic Accommodation Strategy (TAS) and submit it to the Consultant for review 2 weeks prior to the Pre-Construction meeting.
- Implement traffic accommodation measures in accordance with the TAS.
- Ensure that all sub-contractors comply with the accepted TAS.
- Monitor the Work Zone to ensure that the TAS is effective. This requirement is applicable during hours of daylight, darkness, inclement weather, visibility, and regardless of whether or not work is being performed or the project is shut down.
- Maintain all Traffic Control Devices (TCDs).
- TAS may need to be modified on occasion due to site and/or traffic conditions. Alberta Transportation and/or the Consultant may also request modifications to the TAS.
- Take appropriate and timely action to correct any deficiencies identified by the Contractor, the Consultant, public, or the Department. In cases of imminent danger, corrective action must be immediate.
- Report all third party vehicle accidents immediately. Provide a copy of the completed accident report within 72 hours of the occurrence.
- On construction projects, complete daily reports of traffic accommodation details (location, date, time, signs, barricades, etc.) and submit on a weekly basis.
- On construction projects, attend any meetings initiated by the Consultant to address any concerns regarding the performance of the TAS.
- On construction projects, submit a timely and accurate schedule of the sub-contractors' activities prior to commencement of the work.
- Provide a knowledgeable individual at the Work Zone to maintain the TCDs and address any traffic accommodation issues which arise. On construction projects, the Contractor must identify this individual at the pre-construction meeting.

### **B. Consultant**

The following are the Consultant's primary responsibilities for traffic accommodation when administering a Department highway or bridge construction contract.

When a Consultant performs work such as survey and materials testing within the highway right-of-way which does not coincide with the Contractor's activities, the primary responsibilities of the Contractor shall also apply to the Consultant.

## Traffic Accommodation in Work Zones

---

- Identify in the special provisions of a construction contract, any unique situations that will require special traffic accommodation measures. Ensure the Contractor addresses these situations in the Traffic Accommodation Strategy (TAS) (e.g. limiting the length of the Work Zone, establishing the posted speed for the Work Zone, etc.).
- Where applicable, confirm "traffic counts" with the Department Representative and include this information in the special provisions for the contract (several drawings contained in this document require additional Traffic Control Devices (TCDs) for certain traffic volumes).
- Where applicable, confirm requirements for overhead illumination and minimum speeds for the Work Zone/Area (other than flagperson stations) with the Department Representative and include any requirements in the special provisions for the contract.
- Provide suitable traffic accommodation for the Consultant's activities and coordinate the positioning of the Consultant's TCDs with the Contractor and/or Utility Company when necessary.
- Review the Contractor's TAS prior to commencement of the work to determine if it is appropriate for the anticipated site conditions.
- Provide a copy of the Contractor's TAS to the Department Representative for review.
- Liaise with the Contractor to address any concerns with the proposed TAS.
- Notify the local RCMP of the proposed changes to traffic flow. Invite the RCMP to review traffic flows, signage and any other TCDs upon commencement of the work.
- Where applicable, notify local fire department and ambulance service of the impending work and anticipated site conditions.
- Provide the Department Representative with a completed "Order Fixing Maximum Speed Limits" prior to commencement of the work.
- On an on-going basis, monitor the Contractors activities in regards to compliance with the TAS and ensure that the TAS remains effective for the current operating conditions.
- Monitor the Work Zone as the Consultant deems necessary and as the work progresses to determine if the TAS is suitable for each phase of the work and throughout the duration of the project.
- Initiate any meetings required with the Contractor to address any concerns regarding the performance of the TAS.
- Advise the Contractor of any deficiencies in his traffic accommodation measures and ensure that the Contractor takes appropriate and timely corrective action.
- Order the Contractor to suspend work in cases of recognized imminent danger or where the Contractor fails to undertake appropriate and timely measures to accommodate traffic or fails to correct recurring deficiencies. Immediately notify the Department Representative in cases where such orders are issued.
- Immediately notify the Department Representative of any accidents which involve a fatality, serious personal injury, or 3<sup>rd</sup> party property damage as specified in the Traffic Safety Act. Provide the Department Representative with a Motor Vehicle Traffic Collisions Occurring in Work Zones Report within 72 hours of knowledge of the accident. (Report to include photos, details of site conditions, record of signs, etc.)
- Review all daily traffic accommodation reports received from the Contractor.

## C. Utility Company

- When performing work in conjunction with a Department construction contract and inside the Contractor's Work Zone, provide suitable Traffic Control Devices (TCDs) for the utility work and co-ordinate the positioning of these devices with the Contractor and Consultant.
- When performing work which is not inside the Contractor's Work Zone, develop a Traffic Accommodation Strategy (TAS) and submit it to the Department Representative for evaluation at least 2 weeks prior to commencement of the work.
- Provide a knowledgeable individual at the utility Work Area to maintain the TCDs and address any traffic issues which arise. Identify this individual to the Department Representative prior to commencement of the work.
- Implement traffic accommodation measures in accordance with TAS.
- Monitor the utility Work Area to ensure the TAS is effective. Modify the Strategy when necessary and advise the Department Representative accordingly.
- Maintain all TCDs.
- Take appropriate and timely action to correct any deficiencies.
- Ensure that all sub-contractors working for the Utility Company comply with the accepted TAS.
- Report all third party vehicle accidents to the Department Representative immediately. Provide a copy of the completed accident report within 72 hours of the occurrence.

## D. Department

The Department establishes standards for the Specifications and drawings, and ensures that traffic safety is planned for and takes into account the protection of all parties involved on construction, maintenance, and utility work on provincial highways. In addition, the Department performs the following functions.

### On projects where the Department has retained a Consultant

- At the design stage of the project, provide the Consultant with comments regarding the proposed traffic accommodation procedures and assist in the identification of issues that are unique to the project.
- Provide comments to the Consultant concerning the Contractor's proposed Traffic Accommodation Strategy (TAS).
- May periodically visit the Work Zone. During such visits, advise the Consultant of any deficiencies noted in the traffic accommodation measures.
- Order the Contractor to suspend work in cases of recognized imminent danger or where the Contractor fails to take appropriate and timely measures to accommodate traffic. Typically, the Department would only take on this responsibility during a "periodic visit" where the Consultant cannot be contacted to issue the order to suspend work.
- Review Motor Vehicle Traffic Collisions Occurring in Work Zones reports for completeness and report any traffic accommodation signing deficiencies noted to the Consultant so that they can be corrected immediately.

### **On projects where the Department has not retained a Consultant**

- Review the TAS prior to commencement of the work to determine if it is appropriate for the anticipated site conditions.
- Liaise with the person performing the work to address any concerns with the proposed TAS.
- Periodically monitor the Work Zone to ensure the person performing the work implements and maintains the TAS.
- Monitor the Work Zone as the Department deems necessary and as the work progresses to determine if the TAS is suitable for each phase of the work throughout the duration of the project.
- Initiate any meetings required with the Contractor to address any concerns regarding the performance of the TAS.
- Advise the person performing the work of any deficiencies in their traffic accommodation measures and ensure that the Contractor takes appropriate and timely corrective action.
- Order the person performing the work to suspend work in cases of recognized imminent danger or where they fail to undertake appropriate and timely measures to accommodate traffic or fails to correct recurring deficiencies. Immediately notify the Department Representatives in cases where such orders are issued.
- For any accidents, which involve a fatality, serious injury, or 3<sup>rd</sup> party property damage as specified in the Traffic Safety Act, complete a Motor Vehicle Traffic Collisions Occurring in Work Zones Report within 72 hours of knowledge of the accident. (Report to include photos, details of site conditions, record of signs, etc.)

### **E. Municipality**

The following are the municipality's primary responsibilities for traffic accommodation when undertaking work on provincial highways.

- Develop a Traffic Accommodation Strategy (TAS) and submit it to the Department Representative for review 2 weeks prior to the commencement of work.
- Provide a knowledgeable individual at the Work Area to maintain the Traffic Control Devices (TCDs) and address any traffic issues that may arise. Identify this individual to the Department Representative prior to commencing work.
- Implement traffic accommodation measures in accordance with the accepted TAS.
- Monitor the Work Area to ensure the TAS is effective.
- Modify the strategy when necessary and advise the Department Representative accordingly, in writing.
- Maintain all TCDs.
- Take appropriate and timely action to correct any deficiencies.
- Ensure that all Contractors working for the Municipality comply with the TAS.
- Report all third party vehicle accidents to the Department Representative immediately.
- For any accidents, which involve a fatality, serious injury, or 3<sup>rd</sup> party property damage as specified in the Traffic Safety Act, complete a Motor Vehicle Traffic Collisions

Occurring in Work Zones Report within 72 hours of knowledge of the accident. (Report to include photos, details of site conditions, record of signs, etc.)

## **4. Preparing the Traffic Accommodation Strategy (TAS)**

### **4.1 General**

When activities are performed within the highway right-of-way, a Traffic Accommodation Strategy (TAS) is required. To be effective, the TAS must address the traffic accommodation issues relevant to the specific activity being performed, provide protection for workers and equipment within the Work Area and allow traffic to pass safely and with a minimum of inconvenience through or around the Work Zone.

For work performed by a Contractor on a Department construction or highway maintenance contract, the TAS shall be developed by the Contractor.

For work performed by a Utility Company (outside the limits of the Contractor's Work Zone), a TAS shall be developed by the Utility Company.

For work performed by a Consultant (outside the limits of the Contractor's Work Zone), a TAS shall be developed by the Consultant.

On construction contracts, the Contractor must submit the TAS to the Consultant prior to commencement of the work. The Consultant will then review the TAS and address any concerns with the Contractor. The TAS must then be forwarded by the Consultant to the Project Administrator for distribution to the Regional Safety Officer for review. The timelines for the submission and review of the TAS are detailed in the Specifications.

On highway maintenance contracts, TAS for "planned" maintenance activities shall be submitted by the Contractor to the Department Representative for review prior to commencement of the work and in accordance with the Specifications.

For "non-planned" maintenance activities or emergency situations it may not be practical to develop a site-specific TAS. For these cases, typical or generic strategy(s) which generally cover the activities or situations anticipated may be used. These "generic" strategies must also be in place prior to commencement of the work.

When a TAS for work performed by a Consultant, Municipality or Utility Company is required, the Consultant, Municipality or Utility Company shall submit the strategy within the timelines established by the Department Representative.

To achieve consistency in the accommodation of traffic on Department projects, the information and standard drawings contained in Appendix A must always be considered when developing or evaluating a TAS. The information and standard drawings contain minimum

standards for typical conditions. However, the actual requirements for traffic accommodation may vary depending on the complexity of the work activity, traffic volumes, traffic speeds, night time conditions, highway geometrics and other site specific conditions.

### 4.2 Details for Traffic Accommodation Strategy

The objective of a Traffic Accommodation Strategy (TAS) is to safely accommodate both the road users passing through the Work Zone and the workers performing activities within the Work Zone. The complexity of the TAS will vary depending upon a number of factors including traffic volumes and the nature of the activity being performed. Typically, traffic accommodation measures required for Long Duration Projects will be more elaborate than those for Short Duration Projects.

Regardless of the nature of the activity, the following factors should be considered when developing the TAS (A checklist is included in Appendix D):

- Duration of work.
- Traffic volumes (ASDT), peak hours, statutory holidays, special events and recreation traffic, etc.).
- Class of roadway (capacity, level of service, etc.).
- Available sight distance.
- Intersecting roadways.
- Gradeline (steep hills create stopping problems).
- Type of roadway surface (gravel or paved).
- The use of only those Traffic Control Devices (TCDs) which are necessary to clearly warn, advise and control the traffic.
- Speed limits must be appropriate for the conditions. When reductions in speed are necessary, the speed must be reduced over a reasonable distance.
- Devices used to delineate the travel lanes must be appropriate for the intended purpose. Such devices must be visible to traffic and positioned and spaced in a manner which will optimize their effectiveness.
- Stabilizing TCDs with weights when necessary.
- Closing only those lanes necessary to divert traffic around workers and/or equipment.
- The use of flags and/or flashers to increase the visibility or prominence of signs.
- The use of flagpersons, temporary traffic signals, or automated flagging devices for traffic control.
- The effect of restricted traffic flow on "upstream" conditions (traffic congestion, and anticipated queue lengths, etc.)
- Avoid scheduling operations during hours of peak traffic volumes.
- The requirements as illustrated on the standard drawings included in Appendix A pertaining to the use and location of tapers and transitions.
- Weather conditions (dust, rain or snow).
- Site specific safety issues. A site visit should occur before the TAS is developed.
- Pedestrian and cyclist traffic.

## **4.3 Establishing the Traffic Accommodation Strategy**

It is extremely important that all parties have a clear understanding of how traffic will be accommodated before work commences. This information must be detailed in the Traffic Accommodation Strategy (TAS). A copy of the approved TAS must be available on site at all times.

The TAS must contain drawings detailing the configuration of temporary signing and any other Traffic Control Devices (TCDs) which will be used to accommodate traffic. For typical situations, the standard drawings included in Appendix A may be used. For non-typical situations, site specific or activity specific drawings must be developed by the person performing the work.

The TAS must also document procedures which will be used to address issues such as but not limited to the following:

- Installing, relocating and removing TCDs.
- Accommodating over-dimensional vehicles.
- Accommodating vehicles around fresh tack coat.
- Night time and other periods of inactivity.
- Use of detours.
- Accommodating emergency vehicles.
- The use of non-typical lane widths.
- The on-site designate responsible for traffic accommodation.
- Any non-typical situations not covered by the standard drawings.
- Emergency response strategy including a list of the locations and phone numbers of emergency services in the area.

It is critical that all parties are in agreement on the procedures, signing configurations, and TCDs to be used for the accommodation of traffic prior to commencement of the work. Once work commences, changes can be made as conditions dictate. Any change made to the TAS including the reasons or circumstances necessitating the change must be documented in writing.

## **5. General Work Zone Considerations**

### **5.1 General**

In addition to providing safe passage for vehicular, pedestrian and cyclist traffic through the Work Zone, effective traffic accommodation involves minimizing inconvenience to traffic. To ensure traffic moves effectively through the Work Zone, it is critical that the Traffic Control Devices (TCDs) used to advise, warn and direct traffic are appropriate for the site conditions. Any TCDs which are not required must be removed or covered immediately.

In all cases, any required TCDs, flagpersons and detours must be in place prior to the commencement of the work. In additions, the required minimum lane width must be maintained at all times.

## 5.2 Duration of Work

### Long Duration Projects

Due to the varying duration, site conditions and complexity of these types of projects, a specific Traffic Accommodation Strategy (TAS) is required in each instance. When developing a TAS for a Long Duration Project, the following factors must be considered:

- Type of activity (mobile versus stationary).
- Other work planned adjacent to or within the project limits.
- Railway crossings.
- Maintaining traffic control during periods of inactivity (off-hours, downtime, seasonal shutdown, etc.)
- Bridge sites
- Nighttime operations

### Short Duration Projects

Short Duration Projects generally involve activities necessary to preserve or repair existing highways and bridges, to perform testing on existing roadway surfaces or to perform survey measurements within the highway right-of-way. Due to the nature of these activities, the work may be performed in accordance with a scheduled plan similar to Long Duration Projects or, on an emergency (unscheduled) basis. Short Duration Projects may have Work Areas and may involve work on the highway travel lanes, the highway shoulders, in the highway right-of-way and on or around drainage facilities.

### Very Short Duration Projects and Mobile Work Zones

Very Short Duration and Mobile Operations rarely use tapers and channelizing devices to redirect road users due to the time required to set-up and remove these devices. Very Short Duration and Mobile Operations frequently use vehicle-mounted Traffic Control Devices (TCDs), such as arrow boards, portable variable message signs, and high intensity rotating, flashing, or strobe lights to establish a transition area. These Work Zones may also include a work vehicle, buffer vehicle, and an advance warning vehicle.

## 5.3 Detours

In situations where it is necessary to close the entire roadway, a detour must be provided. The scheduling, location and use of a detour requires prior approval of the Department and/or other jurisdictions. Examples of detours include constructed, local roads, median cross-overs,



and counter flow. When utilizing local roads, approval from the appropriate municipality must be obtained.

Where the conditions dictate that construction of a detour is necessary, the Contractor shall design the detour in accordance with the temporary highway detour geometric guidelines contained in the latest edition of the Department manual entitled Highway Geometric Design Guide and also the standard drawings included in Appendix A.

### **5.4 Accommodating Pedestrians and Cyclists**

Pedestrians and cyclists shall be provided with safe passage through or around Work Areas. When passage is provided through the Work Area, suitable provisions shall be made to ensure pedestrians and cyclists are physically separated from workers and equipment. When pedestrian and cyclist traffic cannot be accommodated through the Work Area, an alternate route shall be made available. This may include additional signage to alert pedestrian and cyclist traffic of closures and the option of taking an alternate route to avoid passing through the Work Zone.

### **5.5 Coordination of Activities**

On Department construction projects, it is not uncommon to have the Contractor, Consultant, and/or Utility Company simultaneously performing work within the Contractor's Work Zone. In these situations, it is important that traffic accommodation is a coordinated effort between all parties and that the positioning of Traffic Control Devices (TCDs) required for each activity is established prior to commencement of the work. The responsibility to initiate "contact" for coordinating activities shall reside with the party that is entering a project or site where work has already commenced. The responsibility to initiate contact with all parties within the Work Zone applies regardless of whether the worksites are in the same general vicinity, adjacent or separated by time and/or space. The coordination process will identify prime contractor responsibilities for specific Work Areas and the responsibilities for traffic accommodation and incident reporting. The outcomes should be completed in writing with all parties signing.

### **5.6 Flagpersons and Similar Traffic Control Methods**

In situations where there is a need for greater warning or direction of traffic, the use of flagpersons, automated flagger assistance devices or portable traffic signals may be required. The proper use of these systems to control and direct the flow of traffic can mitigate problems inherent in congested Work Areas and in Work Areas involving reduced lane widths and lane closures. When traffic queues occur, additional flagpersons or devices may be necessary, and the repositioning of the "Flagperson Ahead" or other signs may be required.

#### **5.6.1 Flagperson Apparel and Equipment**

All flagpersons must be certified and their certification must be readily available. Flagpersons shall be dressed in coveralls which meet the Class 3 Level 2 requirements of the most current

## Traffic Accommodation in Work Zones

---

version of CSA Z96, High Visibility Safety Apparel. Each pair of coveralls shall have a permanent label affixed certifying compliance with Class 3 Level 2 of the most current version of CSA Z96.

The colour of the coveralls shall be fluorescent yellow-green with silver retroreflective striping. The retroreflective striping shall be a minimum of 50mm wide, and shall be sewn onto a 100mm wide fluorescent red-orange background material. Flagperson safety apparel shall be kept clean and in good condition at all times. Faded, torn and/or dirty coveralls, or coveralls without CSA certification labels, will not be acceptable, and shall be replaced. Striping requirements are identified in the referred to CSA standard.

Prior to commencement of the work, the Contractor shall identify and assess existing and potential hazards at the project site. Where there is a foreseeable risk of injury to a worker's head, flagpersons shall wear fluorescent orange protective hardhats meeting the requirements of the most current version of CSA standard Z94.1. Where no foreseeable risk of head injury exists, flagpersons will be permitted to wear any type of fluorescent orange headgear.

During hours of darkness, flagpersons shall be equipped with hand held red traffic signal wands of sufficient brightness to be clearly visible to approaching traffic. In addition, flagging stations shall be illuminated by overhead lighting; and signs indicating hazardous conditions and signs requiring increased attention shall be marked with flashers.

### **5.6.2 Automated Flagger Assistance Devices**

Automated Flagger Assistance Devices (AFADs) are mechanical or electronic devices that can be used to control traffic flow in a Work Zone. AFADs replicate the manual flagging process through displays that tell motorists to either stop or slow down. The switch between the two modes is made by flagpersons based on the traffic conditions and work activities. However, as AFADs can be operated from a distance, they reduce flagger exposure to traffic. The Department allows the usage of both Stop/Slow AFADs and Red/Yellow Signal AFADs that meet the Specifications outlined in Work Zone Bulletin #8/2017 Alternatives to Manual Flagging.

Flagpersons operating AFADs are not exempt from the certifications, apparel and other requirements in the above section (Flagperson Apparel and Equipment). In addition, the flagperson must receive specific training on the use of the AFAD. While the device takes over the role of directly interacting with traffic, the flagperson must still appropriately assess the traffic queues and make the decision to change modes. As well, if the AFAD malfunctions, the flagperson operating the device must be able to manually take over the flagging duties immediately.

### **5.6.3 Portable Traffic Signals**

Portable Traffic Signals direct traffic flow with standard traffic signal heads that are attached to a moveable base. These devices do not require a flagperson but operate using either pre-timed or actuated design.

Each traffic signal head is composed of three 300 mm diameter lenses for displaying red, yellow, and green lights. The battery source must be operable within a temperature range of -40 to 40 degrees Celsius and shall be able to provide sufficient light intensity. Portable traffic signals have the operational characteristics of regular traffic signals systems. This includes but is not limited to:

- Presence of a conflict monitor to detect system failure, including the activation of simultaneous green on both approaches.
- Programming to switch to flashing red in the event of device malfunction.
- Ability to provide notification of low power.

### **5.7 The Clear Zone Concept in Work Zones**

The forgiving roadside concept should be applied to all Work Zones as appropriate for the type of work being done and the extent existing roadside conditions allow. This includes providing a clear recovery area for longer term projects and using Traffic Control Devices (TCDs) and safety appurtenances that are crash-worthy or shielded.

Additionally, Work Zones should be developed to provide a safe environment for pedestrians, cyclists, and highway workers. This could mean providing safe pathways where pedestrians and cyclists are allowed to traverse the Work Zone by shielding adjacent excavations or other unsafe areas.

#### **Application of the Clear Zone Concept in Work Zones**

The Work Zone "Clear Zone" is an unobstructed relatively flat area in a Work Zone that extends outward from the edge of the travelled way. The location of the "travelled way" through a Work Zone may be different from the usual highway "travelled way" due to detours or lane closures. The extent of the Clear Zone provided is measured perpendicular from the edge of the travelled way to the face of the closest obstacle or hazard. Because of the limited horizontal clearance available and the heightened awareness of motorists through Work Zones, the Clear Zone requirements are less than the before-work conditions. The amount of available Clear Zone in a Work Zone affects the decision to delineate or shield exposed hazards such as concrete barrier ends, fixed objects, steep slopes or drop-offs.

Engineering judgment must be used in applying the "Clear Zone" to Work Zones. Depending on site restrictions, it may only be feasible to provide an operational clearance. Designers should determine the width of a Work Zone Clear Zone on a project by project basis, considering traffic speeds, volumes, roadway geometrics, available right-of-way, and duration of work.

Where roadside space is available, the Clear Zone provided in the Work Zone should generally comply with the values shown in Table below. The location of collateral hazards such as parked equipment and material storage should be controlled and be subject to a greater Clear Zone distance if/when practical.

## Traffic Accommodation in Work Zones

Generally, for ease of application of the Clear Zones, there is no adjustment made for horizontal curves.

**Table: Suggested Clear Zone Distances for Work Zones**

Posted Speed in Work Zone (km/hr)	Distance (m)
100 - 110	9
90	7
70 - 80	5
less than or equal to 60	4
less than or equal to 60 with barrier curb*	0.5

\* Distance should be measured away from the roadway, starting from the edge of curb.

## 6. Speed Management

### 6.1 Temporary Speed Reductions

When work is performed within the highway right-of-way on Department contracts or agreements, the Department has the authority, under the Traffic Safety Act, to authorize temporary speed reductions in the Work Zones.

On Long Duration Projects, local authorities are made aware of the temporary speed reduction through the issuance of the "Order Fixing Maximum Speed" form.

On Short Duration Projects, the form is not required.

#### 6.1.1 Changes in Traffic Speed

- Generally at locations where the work results in a change to the existing road conditions (i.e. lane restrictions, reduced lane widths, detours, etc.), creates obstructions or requires the presence of workers/equipment in or adjacent to the normal path of travel, a reduced speed zone is warranted. Speeds shall be appropriate for accommodating traffic safely through or around the Work Zone with a minimum of inconvenience.
- Generally, the reduced Work Zone speeds are as noted in the following tables.

#### Two Lane Highways

Speed Limits			Description
50	80	100	
X			<ul style="list-style-type: none"><li>• Traffic is controlled by flagpersons or traffic lights</li><li>• The whole roadway is disrupted with construction or maintenance activities</li><li>• Working on the paved shoulder and encroaching on a travel lane</li></ul>

## Traffic Accommodation in Work Zones

			<ul style="list-style-type: none"> <li>Shoulder width less than 1 m with an unprotected longitudinal drop off</li> </ul>
	X		<ul style="list-style-type: none"> <li>On paving projects with uneven mat up to 65 mm in thickness</li> <li>On paving projects where the center line has been spotted</li> <li>Shoulder width more than 1 m with an unprotected longitudinal drop off</li> <li>Work Area separated by F-shaped concrete barrier system or approved equivalent installed on the road surface</li> </ul>
		X	<ul style="list-style-type: none"> <li>Very Short Duration work; e.g. sign replacement, isolated pothole patching, debris removal, etc. and equipment is parked entirely on the shoulder</li> <li>All work is outside of the paved shoulder; working from the ditch side, mowing, surveying, etc.</li> <li>No changes done to the driving lanes or paved shoulders</li> <li>Work Area separated by F-shaped concrete barrier system or approved equivalent installed off the road surface</li> </ul>

## Multi-lane Highways

Speed Limits				Description
50	80	100	110	
X				<ul style="list-style-type: none"> <li>For emergency detours due to accidents, alignments, obstructions, below design standard.</li> <li>If all traffic must be stopped due to road closures</li> </ul>
	X			<ul style="list-style-type: none"> <li>Any activity when a lane has been closed and separated by traffic delineators, traffic barrels, barricades, etc.</li> <li>Any work activity on a paved shoulder</li> <li>Shoulder width less than 1 m with an unprotected longitudinal drop off</li> </ul>
		X		<ul style="list-style-type: none"> <li>On paving projects with an uneven mat up to 65 mm in thickness</li> <li>On paving projects where the center line has been spotted</li> <li>Shoulder width more than 1 m with an unprotected longitudinal drop off</li> <li>Work Area separated by F-shaped concrete barrier system or approved equivalent installed on the road surface</li> </ul>
			X	<ul style="list-style-type: none"> <li>All work is off the pavement and the unprotected drop-off is less than 300mm</li> <li>No lane encroachment if work is of Very Short Duration; e.g. sign replacement</li> </ul>

## Traffic Accommodation in Work Zones

				<ul style="list-style-type: none"><li>• Work Area separated by F-shaped concrete barrier system or approved equivalent installed off the road surface</li></ul>
--	--	--	--	---

Note: If there are circumstances where the Work Zone speeds are different from those noted above, they will be dealt with in the Special Provisions or by the Department Engineer.

## 6.2 Transitional Speed Reductions

Transition speed zones are used on both Long Duration and Short Duration Projects where the Gazetted Highway Speed in advance of the Work Zone is greater than 30 km/hr above the posted speed in the Work Zone. The transition speed can be either 70 or 80 km/hr and shall be minimum of 300m in length. Drawings TCS-B-4.6A and TCS-B-4.6B are example drawings that show how to incorporate transition speed limit signs into a Work Zone signage strategy.

In most cases, transition speed zones will be applied only to the approach of the Work Zone and not to the exit. Though this creates a differential speed zone, motorist compliance to an exit transition speed zone is likely to be low when there are no longer any apparent hazards or risks. An exit transition speed zone shall be applied on an undivided highway Work Zone only if one of the following conditions exist:

- The difference between the proposed speed limits for each direction of travel is greater than 40km/hr.
- Sight distance is less than 430 meters for one or both directions of travel.
- There are public roadway accesses within the transition speed zone.

## 7. Traffic Control Devices

### 7.1 General

To be effective, Traffic Control Devices (TCDs) must achieve the following:

#### 7.1.1 Awareness and Identification

- Advise road users of the type of activity and the potential hazards that they may encounter.
- Divert traffic from its normal path when necessary.
- Advise road users when it is safe to resume normal speed.

#### 7.1.2 Protection

- Protect road users and workers from collisions by providing adequate warning and/or a barrier. Where access to a road is being denied to the public, barricades shall be installed across the entire surface of the roadway.

### 7.1.3 Lane Delineation

- Provide adequate transitions for the speed and volume of the traffic travelling through the Work Zone.

## 7.2 Temporary Signing

The various types of temporary signing generally used include temporary warning signs, temporary regulatory signs and information signs. Temporary signs must conform to the Specifications for shape, color, reflectivity, message and size. The type, configuration and number of temporary signs required for the Work Zone may vary depending on the nature of the activity and site conditions.

The following factors should be considered when establishing temporary signing:

- Changes to the Work Zone which temporarily or permanently affect signing requirements (covering or removing unnecessary signs, adding additional signs or moving signs).
- During periods of inactivity, all non-applicable portable temporary construction signage, shall be covered, turned or laid face down entirely off the highway shoulder. Sign covers must be sufficient enough to cover the message the sign is portraying.
- Positioning of the signs relative to the travel lane (distance from and height above the travel lane).
- Visibility of the signs (sight distance, vegetation, parked equipment, darkness, dust, etc., which may reduce effectiveness of the signs).
- Signing is required for both sides (in same direction) on multi-lane divided highways.
- Positioning of signs relative to the Work Area.
- Higher speeds require longer spacing between signs.
- The distance between the "reduced speed" sign and the start of the Work Area. This distance will depend on the reduced speed posted. To be effective, the speed and distance used must allow traffic sufficient time to react without creating undue inconvenience.
- The installation of signs on 2 lane highways with a message displayed to opposing traffic is not allowed.
- End of queue.

Once all necessary temporary signs are in place and traffic is passing through the Work Zone, it is extremely important to monitor the Work Zone on a regular basis to ensure that:

- The signing is performing as intended in both daytime and nighttime conditions.
- Maintenance of signs is completed in a timely fashion (replacing damaged signs, repositioning signs, cleaning signs, re-erecting fallen signs, etc.).
- The signing continues to reflect and address the current site conditions.

## 7.3 Sign Types and Sequences

For typical situations, the types and sequence of the signs used for traffic accommodation shall be as shown in the standard drawings included in Appendix A. Additional signs may be required in non-typical situations.

### 7.3.1 Temporary Warning Signs

Temporary warning signs are used to notify road users of specific hazards that may be encountered in the Work Area. If road users are properly alerted to the changing conditions, they can react in sufficient time to pass safely through the Work Zone.

Some examples of temporary warning signs are:

- Road Work
- Flagperson
- Survey Crew
- Uneven Mat
- Begin Detour 300m

### 7.3.2 Regulatory Signs

Regulatory signs impose legal obligations on all traffic. For example, temporary intersections or intersections having temporarily altered traffic patterns, may require stop signs.

Some examples of temporary regulatory signs are:

- One-Way Traffic
- Two-Way Traffic
- Do Not Pass
- Maximum Speed Ahead

### 7.3.3 Information (Guide) Signs

In certain situations, it may be desirable to use information signs to supplement the warning and regulatory signs. For example, detour guide signs and route markers are used to direct traffic to alternate routes, even though the Work Zone is not closed to traffic.

## 7.4 Sign Spacing

The spacing between each sign must be of a sufficient distance to allow travelers to react to the sign message before reaching the next sign or Traffic Control Device. The optimal sign spacing will vary depending on the posted speed for the Work Zone and will generally range from 25m to 150m.



Sign spacing for Urban and Rural Highways are identified on the standard drawings included in Appendix A.

### 7.5 Size of Signs on Urban and Rural Highways

The sizes of the various signs are as shown on the Urban and Rural Sign Schedules included in Appendix C.

High speed multilane Urban Highways typically handle large volumes of traffic. In these situations, standard sized signs would not normally be effective. Therefore, on multilane urban highways where the original Gazetted Speed is greater than 60 km/hr and the Average Summer Daily Traffic volume (ASDT) exceeds 10,000 vehicles per day, oversize signs are required. On Rural Highways, standard sized signs are normally sufficient.

On Long Duration Projects, the initial sign "Construction Ahead" / "Bridge Construction Ahead/Bridge Construction 3 km" shall be 120 cm x 120 cm.

### 7.6 Installation of Temporary Signs

Temporary signs must be erected such that the face of the sign is clearly visible to oncoming traffic. On 2-lane undivided highways, the signs must be located on the right hand side of the road. On multilane divided highways, signs must be installed on both the shoulder side and the median side of the highway. Special brackets, if required, need to be fabricated for installing signs on a concrete median.

Temporary signs may be mounted on posts or on portable stands. Generally, posts are used on Long Duration Projects where the Work Area is stationary. The use of portable stands is better suited for situations where the Work Area is mobile or where the duration of work is relatively short. If traffic control is required overnight, signs shall be installed on posts or acceptable industry standard sign stands at a height of 1.5m. Signs on posts must be placed at a lateral distance of no less than 2m and no more than 6m from the nearest traffic lane.

The position and height of all signs relative to the roadway surface must conform with the Specifications. On Long Duration Projects, the height of the sign relative to the roadway is 1.5 meters. On Short Duration Projects, a 0.3 meter height is necessary. The posts and portable stands on which the signs are installed and any objects used to stabilize the portable stands must be an accepted industry standard and must not present a hazard to traffic.

In situations where it is necessary to make specific temporary signs more prominent, attaching flags and/or flashers may be appropriate.

### 7.7 Double Fines in Work Zones

"Speed Fines Doubles Begins" and "Speed Fines Double Ends" signs are used to define the active Work Areas where the workers are actually present. Where there are no active Work

Areas, these signs must be covered and/or removed. If the Work Zone uses transition speed zones, the "Double Fine" signs are placed in conjunction with the lowest Work Zone speed limit. Drawing TCS-B-4.4 shall be used as a reference when incorporating "Double Fine Begins" and "Double Fine Ends" signs into the project signage strategy.

The signs must be used for all stationary projects that are five days or more, where the highway speed limit is greater than 70 km/hr when not under construction. The signs can be used for Shorter Duration Projects, mobile work, or lower speed situations where practical.

In situations where the signs are not used but workers are present, motorists can still be issued double fines. The purpose of the signs is only to reinforce and remind drivers of existing legislation.

### **7.8 Sequential Arrow Boards and Variable Message Boards**

In situations where lane closures are necessary on multi-lane highways, a sequential arrow board is required to supplement the signing. Sequential arrow boards must always be used in conjunction with other Traffic Control Devices (TCDs).

Sequential arrow boards are very effective for:

- Providing traffic with positive guidance for passing to the left or right of the Work Area.
- Encouraging traffic to leave the closed lane well in advance of the Work Area.
- Providing additional advance warning.

Sequential arrow boards must not be used on highways with opposing traffic.

On Urban Highways, when the ASDT exceeds 10,000 vehicles per day or when sight distance is restricted, an electronic variable message board is also required in advance of the sequential arrow board.

On Rural Highways, when the ASDT exceeds 10,000 vehicles per day, an advance sequential arrow board or electronic variable message board is required.

The electronic variable message board should be strategically placed in advance of the Work Area to best advise motorists of detours, alternate routes or highway conditions. This device should be positioned on the same side as the lane closure. These devices should be placed on the side slope in such a way as to not impact intersection sight lines. If the side slope is not suitable, consider the use of an approach.

Sequential arrow boards and electronic variable message boards must conform with the Specifications. Electronic Message Board messages are to be reviewed by the Consultant.

## 7.9 Delineators

Delineators are used to outline lane transitions and indicate the intended path for road users passing through the Work Area and for separating the traffic lanes from the Work Areas. Effective delineation can be achieved through the use of chevrons, traffic barrels/drums, traffic cones (including tubular delineators) or other similar devices. Delineators are not to be used without the appropriate advance warning signage.

To be effective, delineators must be reflectorized and the proper size. When traffic cones are used, the size required is dependent on traffic speed. Where the speed in the Work Area is greater than 50 km/hr, traffic cones must be a minimum of 70 cm in height. Where the speed in the Work Area is 50 km/hr or less, the height of the traffic cones may be a minimum of 45 cm.

Typical situations where delineators are used:

- Lane closure
- Lane closure tapers
- Shoulder closure tapers
- Downstream tapers
- To separate opposing lanes of traffic
- To identify temporary hazardous conditions (vertical cuts on roadway shoulders, etc.)
- Detours

## 7.10 Tapers

Generally, on multi-lane highways, tapers shall be 40:1. However, on multi-lane highways through urban areas where the original Gazetted Speed is less than 60 km/hr and multiple, closely spaced intersections prevent the use of a 40:1 taper, the taper length may be reduced to 5:1.

Where consecutive tapers are required for lane closures on a multi-lane highway, the standard drawings indicate that a distance of 350 m to 500 m be maintained between the tapers. In situations where site conditions do not allow the minimum distance to be used, the distance between the tapers may be reduced.

On two-lane highways tapers shall be 5:1.

Tapers require delineation. On Rural Highways, glow posts, cones or traffic barrels/drums may be used. On Urban Highways, traffic barrels/drums must be used if the original Gazetted Speed is greater than 60 km/hr.

On multi-lane Long Duration bridge projects, traffic barrels/drums must be used to delineate tapers. For two-lane bridge projects, glow posts, cones or traffic barrels/drums may be used.

The number and spacing required for devices delineating tapers and travel lanes is shown on the standard drawings.

## 7.11 Specialized Traffic Control Devices

There are several other Traffic Control Devices (TCDs) that can be used to supplement standard traffic control measures. These devices are generally used in unique situations or for specific activities (e.g. extremely high traffic volumes, seal coat projects, etc.).

Examples of specialized TCDs are:

- Portable Rumble Strips
- Special information signs developed for unique projects
- Pilot vehicles

## 7.12 Overhead Illumination and Flashers

Activities within the Work Zone often create conditions on or near the travel lane that are particularly hazardous at night when the road user's visibility is reduced. It is often necessary to supplement the reflectorized signs, barriers and channelizing devices with overhead lighting and/or barricade warning lights. Special attention must be taken to ensure that portable overhead lighting does not "blind" the road users.

Barricade warning lights are either steady-burn or flashing type units. Steady-burn lights are used for delineation and should be mounted on a series of barricades or channelizing devices. Flashing lights are used to draw attention to warning signs, obstructions or other hazards in the Work Zone.

The types and intended use of barricade warning lights are:

- Type A

Type A Low Intensity Flashing Warning lights are most commonly mounted on barricades or advance warning signs, and are intended to warn motorists of an obstacle or other potential hazard.

- Type C

Type C Steady Burn lights are used to delineate the edge of the travelled way on detour curves, lane changes and transitions.

## 7.13 Protective Barriers

Protective barriers shall be used on Long Duration Projects with stationary Work Areas where it is necessary to provide a barrier between the travel lane and the Work Area due to worksite hazards and/or the need to maintain higher speeds. Barriers to be installed as per manufacturers specifications. Screening may be required on the barriers in situations where a visual barrier is required for the Work Area or where headlight glare from approaching vehicles

is a problem. The type and style of barrier must also take deflection distances into account to ensure the barrier is acceptable for the specific roadway.

Protective barriers must meet the requirements of NCHRP 350 or MASH 2009 and the applicable Test Level, which may be used where the design deflection room is available behind the barrier and where the Work Zone speed of the adjacent travel lanes is consistent with the crash test speed. For example, TL-4 and TL-3 systems are acceptable for operating speeds of 110 km/hr and 100 km/hr. TL-2 is acceptable for 70 km/hr. Refer to Roadside Design Guide for the latest drawing CB-6-4.2M16, TEB-3.19 or approved equivalent.

### **7.14 Water Filled Barricades**

Water filled barricades can be used if the Gazetted Speed is 60 km/hr or less and the drop off is less than 300 mm in height. Barricades shall be fully filled at all times with water. When sub-zero temperature is conceivable, non-freezing ballast of equivalent specific gravity shall be used.

## **8. Monitoring Traffic Accommodation**

### **8.1 General**

To ensure traffic control measures are performing as intended, it is necessary to monitor and maintain the Traffic Control Devices (TCDs) on a regular basis. The person performing the work designates a specific individual to perform this function and ensure any issues arising are addressed in a consistent and timely manner. To be effective in this role, such individuals must be knowledgeable in the processes and procedures for accommodating traffic including the use of all types of TCDs.

### **8.2 Daily Inspections**

The person performing the work must document specific information concerning the temporary construction signing and any other Traffic Control Devices (TCDs) used to accommodate traffic through the Work Zone. This information is recorded each day, from the date that Work Zone signs are installed until they are removed and as the Work Area changes. A sample form is included in Appendix D. The person performing the work may develop and use their own form provided it clearly contains all the information shown on the sample form.

Information to be recorded includes the following:

- Project description.
- Date and time the TCDs were inspected by the Contractor.
- Station number of the beginning of each Work Area.
- Designation and location (station number) of the temporary construction sign immediately prior to each Work Area.

## Traffic Accommodation in Work Zones

---

- "Reference number" of the signing drawing which reflects the temporary construction signing existing at the time of the inspection. Typically, the drawing referenced will be one which forms part of the Traffic Accommodation Strategy (TAS).
- Any significant issues concerning the signing, including any variations between the actual signing and that which is shown on the signing drawing. This information should be noted in the "comments" section of the form.
- Video logs are acceptable as a supplement to the written record.

As a minimum, all signing must be inspected and the information recorded at both the commencement and end of work each day and also at any other times throughout the day when signs are moved or changed. Additional inspections may be required during weather events such as snow, rain, and wind.

Recording this information does not relieve the person performing the work of his responsibility to ensure that the traffic accommodation activities comply with the TAS at all times during the project.

### **8.3 Hours of Darkness Inspections**

Traffic accommodation must provide sufficient direction and warning to the public during hours of daylight and also hours of darkness. Inspections during hours of darkness must be completed on a regular basis, the frequency of the inspections is dependent on the complexity of the traffic accommodation and/or can be identified in the Special Provisions. If there are ongoing concerns with the traffic accommodation for the project, nighttime inspections may become more frequent.

At a minimum, inspections during hours of darkness must be completed every two weeks. It is also required to complete nighttime inspections whenever there has been a significant change in the traffic accommodation, and after extreme weather events that may have affected the functionality of the traffic accommodation. The intent of the inspections is to review the reflectivity of the devices, functionality of the lamps, and the ease in navigating through the Work Zone. The inspection should occur with low headlight beam to ensure all devices are visible.

As with daytime inspections, a record must be kept and submitted to the Consultant on request.

### **8.4 Compliance with Contract Specifications and Traffic Accommodation Strategy on Department Construction Contracts**

It is the Department's expectation that the Contractor complies with the Specifications for traffic accommodation and the Traffic Accommodation Strategy (TAS) at all times throughout the duration of the project. In situations where the Contractor is not in compliance with these

## Traffic Accommodation in Work Zones

---

requirements, the Consultant has the authority to order the Contractor to suspend work on the project. Although ordering the immediate suspension of work will ultimately achieve compliance with the Specifications, it may not be practical or desirable to take this course of action in all cases. Therefore, to ensure proper administration of this authority the Consultant must exercise good judgement in each case.

In a situation where there is recognized imminent danger to road users, the suspension of work must be immediate and must continue until the Contractor has rectified the deficiency to the satisfaction of the Consultant.

When an infraction or deficiency is considered to be minor and does not result in imminent danger, an escalating resolution process should be used.

In these cases, the Consultant's first attempt to have the issue resolved should be through verbal communication with the Contractor. At this stage, it may be beneficial for the Consultant to meet with the Contractor, identify or explain the nature of the deficiency, confirm expectations and discuss possible solutions to help prevent a reoccurrence of the deficiency.

If the infraction or some similar type of deficiency reoccurs, the Consultant must issue a written warning, advising the Contractor that continued infractions will result in the issuance of an order to suspend work on the project. A copy of this written warning must be forwarded to the Contractor's head office and the Project Sponsor. At this point the Contractor should examine his existing methods or processes for accommodating traffic and consider making modifications which will prevent reoccurring infractions and ensure compliance with the Specifications. The nature of the methods or processes required to ensure compliance with the Specifications is totally the responsibility of the Contractor.

If after the issuance of a written warning infractions continue to occur, the Consultant must issue the Contractor with a written order to suspend work on the project. At this point, the Project Sponsor must be notified of the conditions at the Work Zone and the Contractor's failure to comply with the contract requirements.

When a written order to suspend work is issued, the "order" may cover a specific phase of the work (being performed by a sub-contractor) or the entire project, as actual conditions dictate. In all cases, the Contractor is totally accountable for the performance of his sub-contractors.

The written order to suspend work remains in effect until the Contractor rectifies the deficiency. Further, when an order to suspend work has been issued, it is recommended that the Consultant arrange a meeting between himself, the Project Sponsor, and senior official of the Contractor to discuss the problems associated with traffic accommodation on the project and to establish measures which will prevent future occurrences of non-compliance.

It is the Department's intent and expectation that in all cases, deficiencies in traffic accommodation are addressed in a prompt and effective manner. Therefore, this escalating resolution process may culminate over a period of days or within a single day, depending on the nature of the deficiency.

Repeated non-compliance by Contractors on previous Department projects may require that alternative measures be used to ensure effective traffic accommodation. In these cases, the Project Sponsor should confirm expectations and the manner in which non-compliance will be handled with the Consultant and the Contractor prior to commencement of the work.

## **9. Standard Drawings for Urban Highways**

The standard drawings for Urban Highways are categorized as either "High Speed/High Traffic Volume" or "Low Speed/Low Traffic Volume". These categories represent the majority of urban situations in the province. Other urban situations such as low speed/high volume represent infrequent or unique situations and must be addressed on a project by project basis.

The Gazetted Speed is the determining factor for establishing the required sign sizes.

The ASDT volumes for provincial highways can be obtained on the Department's website.



# **APPENDIX A**

## **STANDARD DRAWINGS FOR TRAFFIC CONTROL ON RURAL AND URBAN HIGHWAYS**

## TRAFFIC ACCOMMODATION IN WORK ZONES

### Drawings by Category

\*Click the links below to get to the Table of Contents of each Category.\*

#### STANDARD DRAWINGS FOR RURAL HIGHWAYS

[Long Duration](#)

[Short Duration](#)

[Testing, Surveying, and Other Short Duration Activities](#)

[Utilities Construction](#)

#### STANDARD DRAWINGS FOR URBAN HIGHWAYS

[High Speed/High Volume](#)

[Low Speed/Low Volume](#)

#### OTHER DRAWINGS

[Standard Drawings for Traffic Control Devices](#)

[Work Zone Bulletin Drawings](#)

[Emergency Activities](#)

## TRAFFIC ACCOMMODATION IN WORK ZONES

### LIST OF DRAWINGS

Click the links below to get to the drawings. To go back to the Drawings by Category Table of Contents: click [here](#)

RURAL HIGHWAYS- LONG DURATION			
TCS-B Drawing No.	2 Lane Undivided	4 Lane Divided	Description
<a href="#">1.1A</a>	X		<a href="#">One Lane Closure (One Lane Alternating Traffic)</a>
<a href="#">1.1B</a>		X	<a href="#">One Lane Closure</a>
<a href="#">1.2A</a>	X		<a href="#">No Lane Closure</a>
<a href="#">1.2B</a>		X	<a href="#">No Lane Closure</a>
<a href="#">1.3A</a>	X		<a href="#">Two Way Traffic (Reduced Roadway Width)</a>
<a href="#">1.4A</a>	X		<a href="#">Intersecting Roads</a>
<a href="#">1.4B</a>		X	<a href="#">Intersecting Roads</a>
<a href="#">1.5A</a>	X		<a href="#">Obstruction Within Work Area</a>
<a href="#">1.6A</a>	X		<a href="#">Truck Entrance (Haul Route)</a>
<a href="#">1.6B</a>		X	<a href="#">Truck Entrance (Haul Route)</a>
<a href="#">1.7A</a>	X		<a href="#">No Centre Line Pavement Marking</a>
<a href="#">1.7B</a>		X	<a href="#">No Centre Line Pavement Marking</a>
<a href="#">1.8A</a>	X		<a href="#">Detour</a>
<a href="#">1.9A</a>	X		<a href="#">Shoulder Drop-Off (Within Work Zone)</a>
<a href="#">1.11A</a>	X		<a href="#">Delineation for Embankments and Fixed Objects (Within The Work Zone)</a>
<a href="#">1.11B</a>		X	<a href="#">Delineation for Embankments and Fixed Objects (Within The Work Zone)</a>
<a href="#">1.15B</a>		X	<a href="#">Bridge Deck Repair (Outside Lane) Clover Leaf Interchanges</a>
<a href="#">1.16B</a>		X	<a href="#">Bridge Deck Repair (Inside Lane) Clover Leaf Interchanges</a>
<a href="#">1.17A</a>	X		<a href="#">Chip Seal Coating Operations</a>
<a href="#">1.17B</a>		X	<a href="#">Chip Seal Coating Operations</a>
<a href="#">1.18A</a>	X		<a href="#">Double Seal and Graded Aggregate Seal Coating Operations</a>

## TRAFFIC ACCOMMODATION IN WORK ZONES

### LIST OF DRAWINGS

RURAL HIGHWAYS- LONG DURATION BRIDGE SIGNING			
TCS-B Drawing No.	2 Lane Undivided	4 Lane Divided	Description
<a href="#">1.19B</a>		X	<a href="#">Work Zone Speed &gt;60km/h</a>
<a href="#">1.20B</a>		X	<a href="#">Work Zone Speed &gt;60km/h or Work Area &gt;300mm Drop Reduced Bridge Width</a>
<a href="#">1.21B</a>		X	<a href="#">Work Zone Speed &gt;60km/h or Work Area &gt;300mm Drop One Lane Closure</a>
<a href="#">1.22A</a>	X		<a href="#">Work Zone Speed &lt;60km/h Two Way Traffic</a>
<a href="#">1.23B</a>		X	<a href="#">Work Zone Speed &lt;60km/h</a>
<a href="#">1.24B</a>		X	<a href="#">Work Zone Speed &lt;60km/h and Work Area &lt;300mm Drop</a>
<a href="#">1.25B</a>		X	<a href="#">Work Zone Speed &lt;60km/h and Work Area &lt;300mm Drop One Lane Closure</a>
<a href="#">1.26A</a>	X		<a href="#">Work Zone Speed &lt;60km/h and Work Area &lt;300mm Drop One Lane Alternating Traffic</a>
<a href="#">1.27A</a>	X		<a href="#">Work Zone Speed &lt;60km/h and Work Area &gt;300mm Drop One Lane Alternating Traffic</a>

<a href="#">1.28</a>	X		<a href="#">Example of Clear Zone Application for Work Area Two Lane Undivided Highway (One Lane Alternating Traffic)</a>
<a href="#">1.28A</a>	X		<a href="#">Localized Excavation Adjacent to Shoulder (Within Work Zone)</a>
<a href="#">1.28B</a>		X	<a href="#">Localized Excavation Adjacent to Shoulder (Within Work Zone)</a>
<a href="#">1.29</a>		X	<a href="#">Example of Clear Zone Application for Work Area Four Lane Divided Highway</a>
<a href="#">1.29B</a>			<a href="#">Highway Transition from Four Lane Divided to Two Lane Undivided</a>

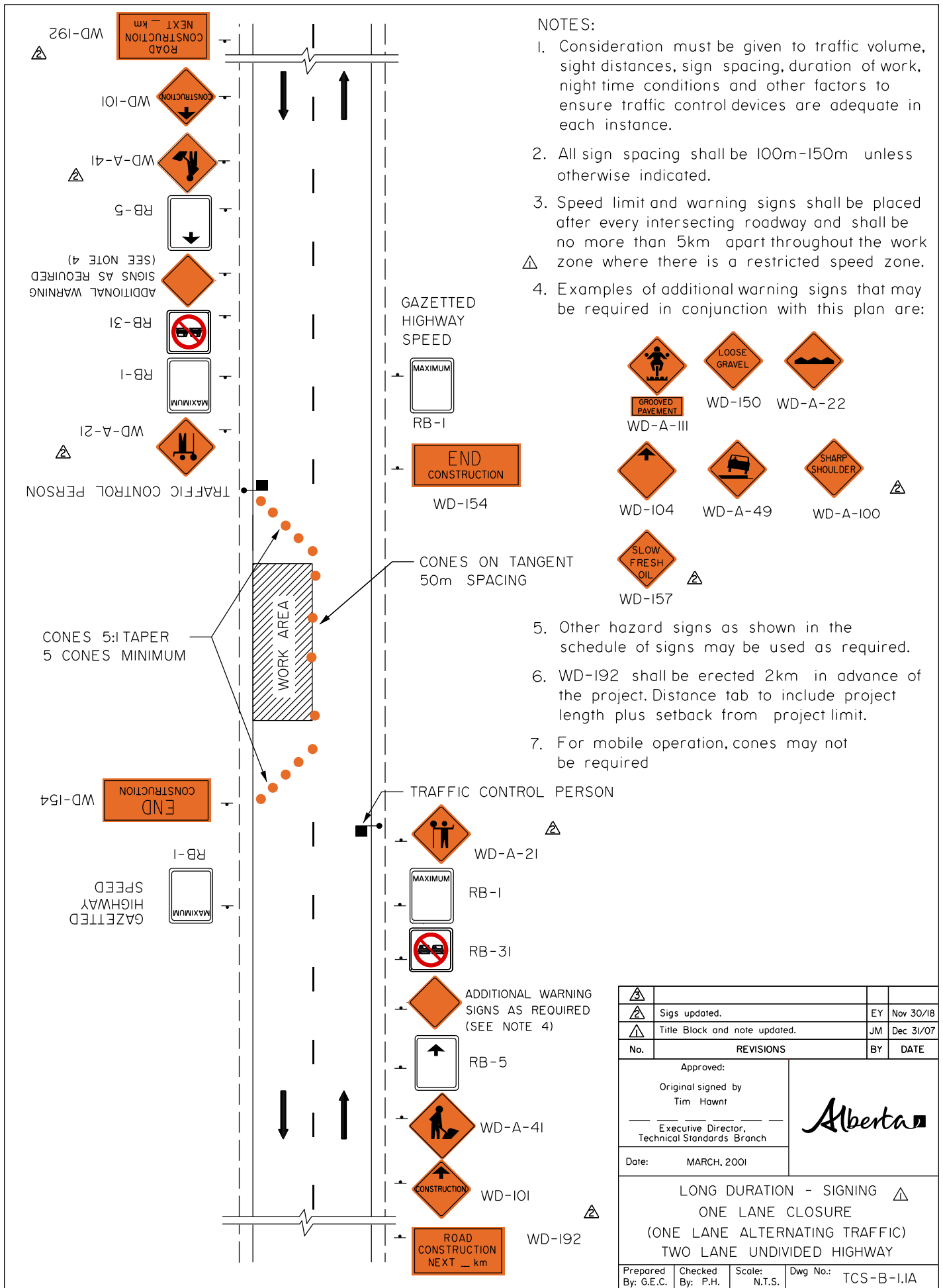

**NOTES:**

1. Consideration must be given to traffic volume, sight distances, sign spacing, duration of work, night time conditions and other factors to ensure traffic control devices are adequate in each instance.
2. All sign spacing shall be 100m-150m unless otherwise indicated.
3. Speed limit and warning signs shall be placed after every intersecting roadway and shall be no more than 5km apart throughout the work zone where there is a restricted speed zone.
4. Examples of additional warning signs that may be required in conjunction with this plan are:
  - GROOVED PAVEMENT WD-A-III
  - LOOSE GRAVEL WD-150
  - SHARP SHOULDER WD-A-22
  - SLOW FRESH OIL WD-157
  - CONSTRUCTION WD-104
  - GROOVED PAVEMENT WD-A-49
  - SHARP SHOULDER WD-A-100
5. Other hazard signs as shown in the schedule of signs may be used as required.
6. WD-192 shall be erected 2km in advance of the project. Distance tab to include project length plus setback from project limit.
7. For mobile operation, cones may not be required

	Sigs updated.	EY	Nov 30/18
	Title Block and note updated.	JM	Dec 31/07
No.	REVISIONS	BY	DATE
Approved:			
Original signed by Tim Hawn			
Executive Director, Technical Standards Branch			
Date:	MARCH, 2001		
LONG DURATION - SIGNING ONE LANE CLOSURE (ONE LANE ALTERNATING TRAFFIC) TWO LANE UNDIVIDED HIGHWAY			
Prepared By: G.E.C.	Checked By: P.H.	Scale: N.T.S.	Dwg No.: TCS-B-1.1A

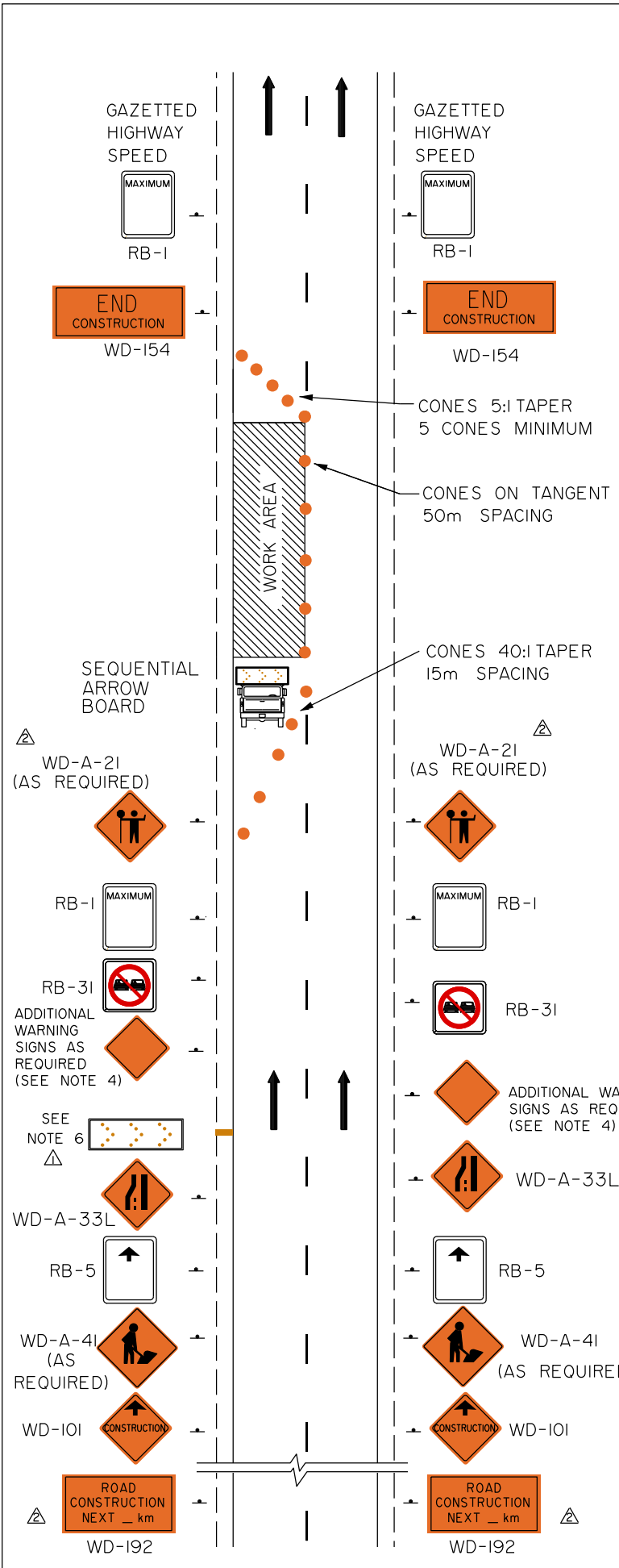

NOTES:

1. Consideration must be given to traffic volume, sight distances, sign spacing, duration of work, night time conditions and other factors to ensure traffic control devices are adequate in each instance.
2. All sign spacing shall be 100m-150m unless otherwise indicated.
3. Speed limit and warning signs shall be placed after every intersecting roadway and shall be no more than 5km apart throughout the work zone where there is a restricted speed zone.
4. Examples of additional warning signs that may be required in conjunction with this plan are:

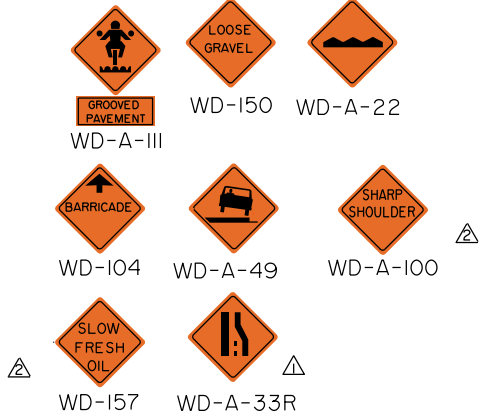

5. Other hazard signs as shown in the schedule of signs may be used as required.
6. The Sequential Arrow Board shall be located in the centre of the closed lane. An additional Sequential Arrow Board is required when traffic volume exceeds 10000 vehicles per day (ASDT) or when sight distance is restricted.
7. WD-192 shall be erected 2km in advance of the project. Distance tab to include project length plus setback from project limit.
8. For mobile operation, cones may not be required.

△			
△	Sigs updated.	EY	Nov 30/18
△	Notes and Title Block updated and sign added	JM	Dec 31/07
No.	REVISIONS	BY	DATE
Approved:			
Original signed by Tim Hawnt			
Executive Director, Technical Standards Branch			
Date:	MARCH, 2001		
LONG DURATION - SIGNING △			
ONE LANE CLOSURE			
FOUR LANE DIVIDED HIGHWAY			
Prepared By: G.E.C.	Checked By: P.H.	Scale: N.T.S.	Dwg No.: TCS-B-1.IB

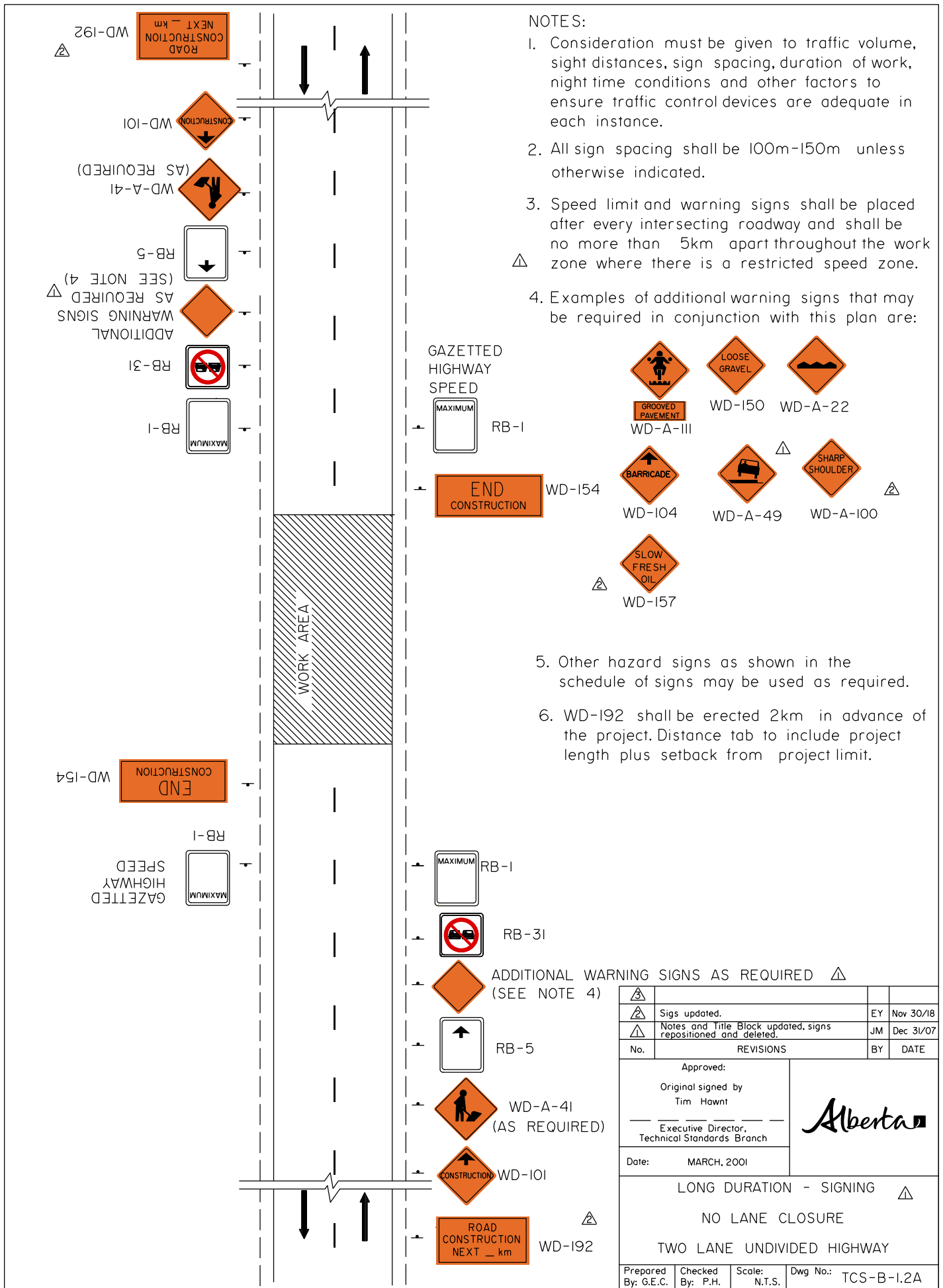

**NOTES:**

1. Consideration must be given to traffic volume, sight distances, sign spacing, duration of work, night time conditions and other factors to ensure traffic control devices are adequate in each instance.
2. All sign spacing shall be 100m-150m unless otherwise indicated.
3. Speed limit and warning signs shall be placed after every intersecting roadway and shall be no more than 5km apart throughout the work zone where there is a restricted speed zone.
4. Examples of additional warning signs that may be required in conjunction with this plan are:
  - WD-150 (Loose Gravel)
  - WD-A-22 (Grooved Pavement)
  - WD-A-104 (Barricade)
  - WD-A-49 (Car on shoulder)
  - WD-A-100 (Sharp Shoulder)
  - WD-157 (Slow Fresh Oil)
5. Other hazard signs as shown in the schedule of signs may be used as required.
6. WD-192 shall be erected 2km in advance of the project. Distance tab to include project length plus setback from project limit.

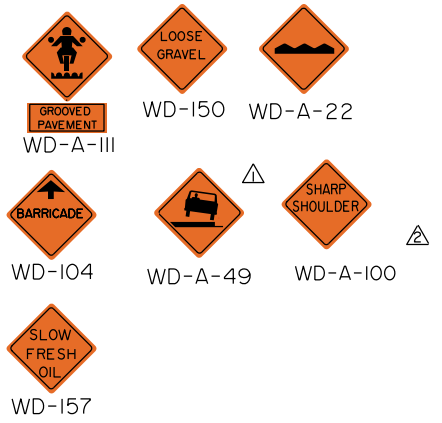

No.	REVISIONS	BY	DATE
1	Sigs updated.	EY	Nov 30/18
2	Notes and Title Block updated, signs repositioned and deleted.	JM	Dec 31/07

Approved:		
Original signed by Tim Hawnt Executive Director, Technical Standards Branch		
Date:	MARCH, 2001	

LONG DURATION - SIGNING			
NO LANE CLOSURE			
TWO LANE UNDIVIDED HIGHWAY			

Prepared By: G.E.C.	Checked By: P.H.	Scale: N.T.S.	Dwg No.: TCS-B-1.2A
---------------------	------------------	---------------	---------------------

NOTES:

1. Consideration must be given to traffic volume, sight distances, sign spacing, duration of work, night time conditions and other factors to ensure traffic control devices are adequate in each instance.
2. All sign spacing shall be 100m-150m unless otherwise indicated.
3. Speed limit and warning signs shall be placed after every intersecting roadway and shall be no more than 5km apart throughout the work zone where there is a restricted speed zone.
4. Examples of additional warning signs that may be required in conjunction with this plan are:

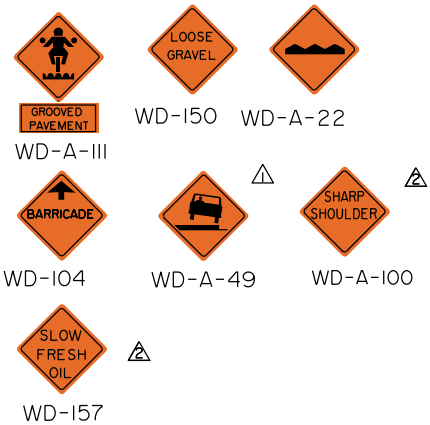

5. Other hazard signs as shown in the schedule of signs may be used as required.
6. WD-192 shall be erected 2km in advance of the project. Distance tab to include project length plus setback from project limit.

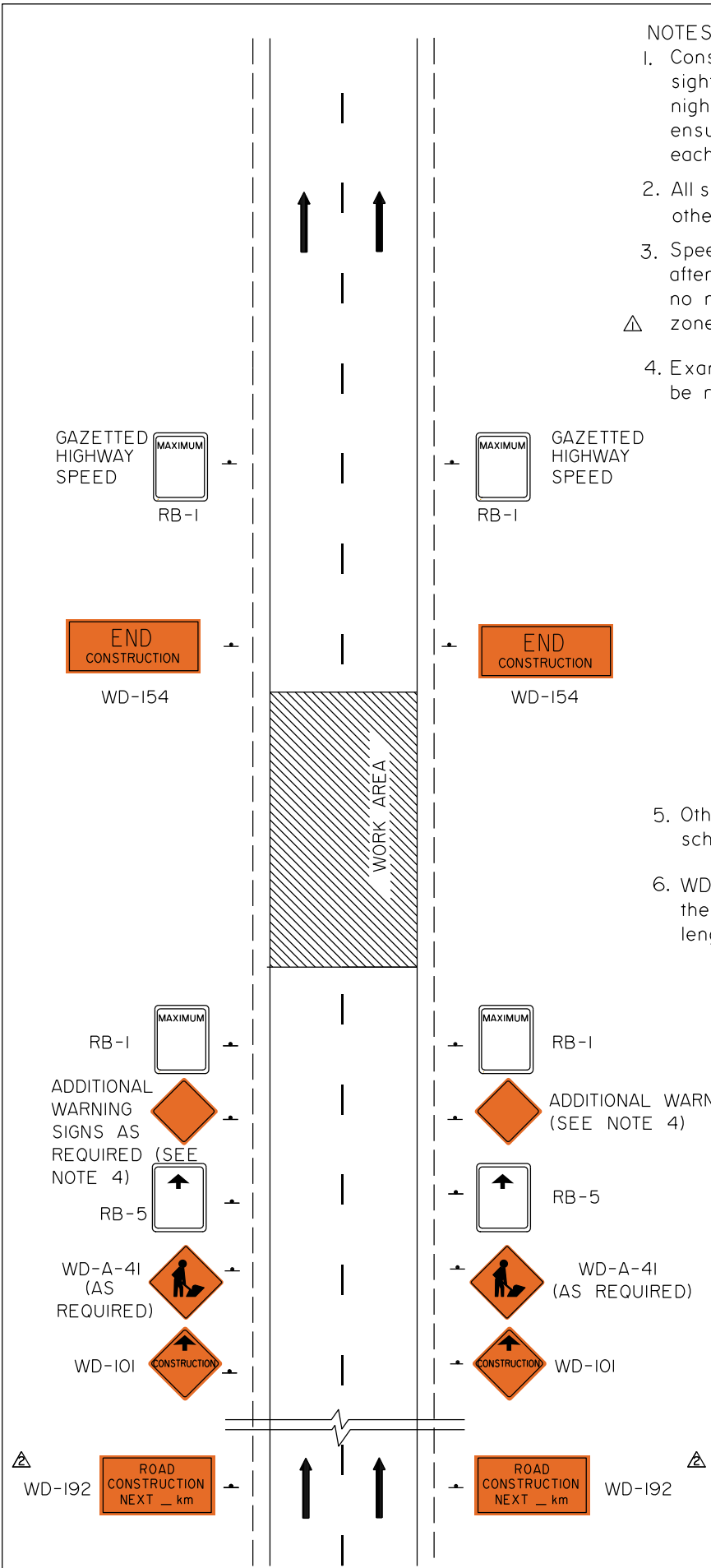

	Sigs updated.	EY	Nov 30/18
	Sign deleted, note and Title Block updated.	JM	Dec 31/07
No.	REVISIONS	BY	DATE
Approved:			
Original signed by Tim Hawnt			
Executive Director, Technical Standards Branch			
Date:			
LONG DURATION - SIGNING NO LANE CLOSURE FOUR LANE DIVIDED HIGHWAY			
Prepared By: G.E.C.	Checked By: P.H.	Scale: N.T.S.	Dwg No.: TCS-B-1.2B



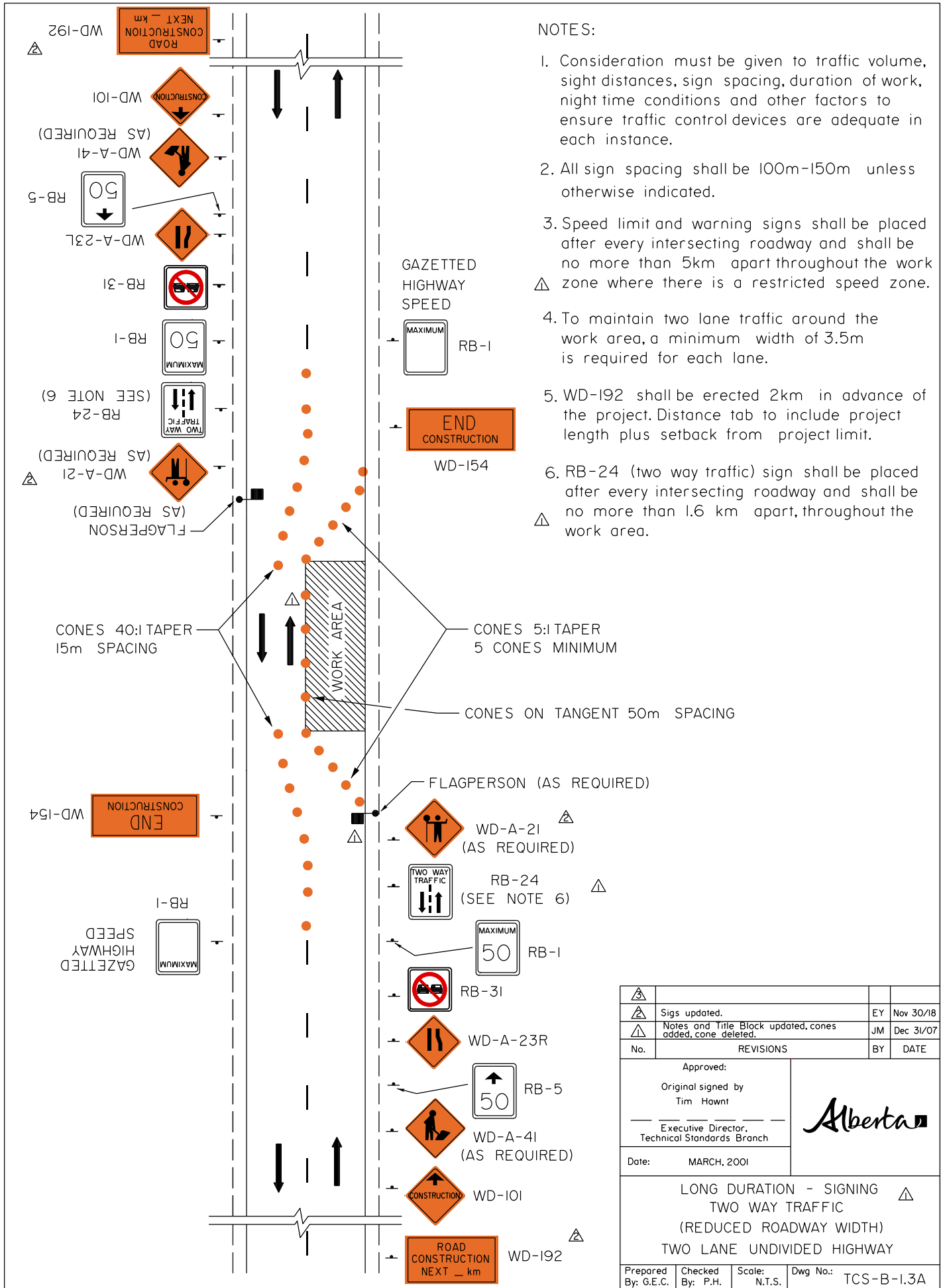

NOTES:

1. Consideration must be given to traffic volume, sight distances, sign spacing, duration of work, night time conditions and other factors to ensure traffic control devices are adequate in each instance.
2. All sign spacing shall be 100m-150m unless otherwise indicated.
3. Speed limit and warning signs shall be placed after every intersecting roadway and shall be no more than 5km apart throughout the work zone where there is a restricted speed zone.
4. To maintain two lane traffic around the work area, a minimum width of 3.5m is required for each lane.
5. WD-192 shall be erected 2km in advance of the project. Distance tab to include project length plus setback from project limit.
6. RB-24 (two way traffic) sign shall be placed after every intersecting roadway and shall be no more than 1.6 km apart, throughout the work area.

△			
△	Sigs updated.	EY	Nov 30/18
△	Notes and Title Block updated, cones added, cone deleted.	JM	Dec 31/07
No.	REVISIONS	BY	DATE
Approved:			
Original signed by Tim Hawnt			
Executive Director, Technical Standards Branch			
Date:	MARCH, 2001		
LONG DURATION - SIGNING △ TWO WAY TRAFFIC (REDUCED ROADWAY WIDTH) TWO LANE UNDIVIDED HIGHWAY			
Prepared By: G.E.C.	Checked By: P.H.	Scale: N.T.S.	Dwg No.: TCS-B-1.3A

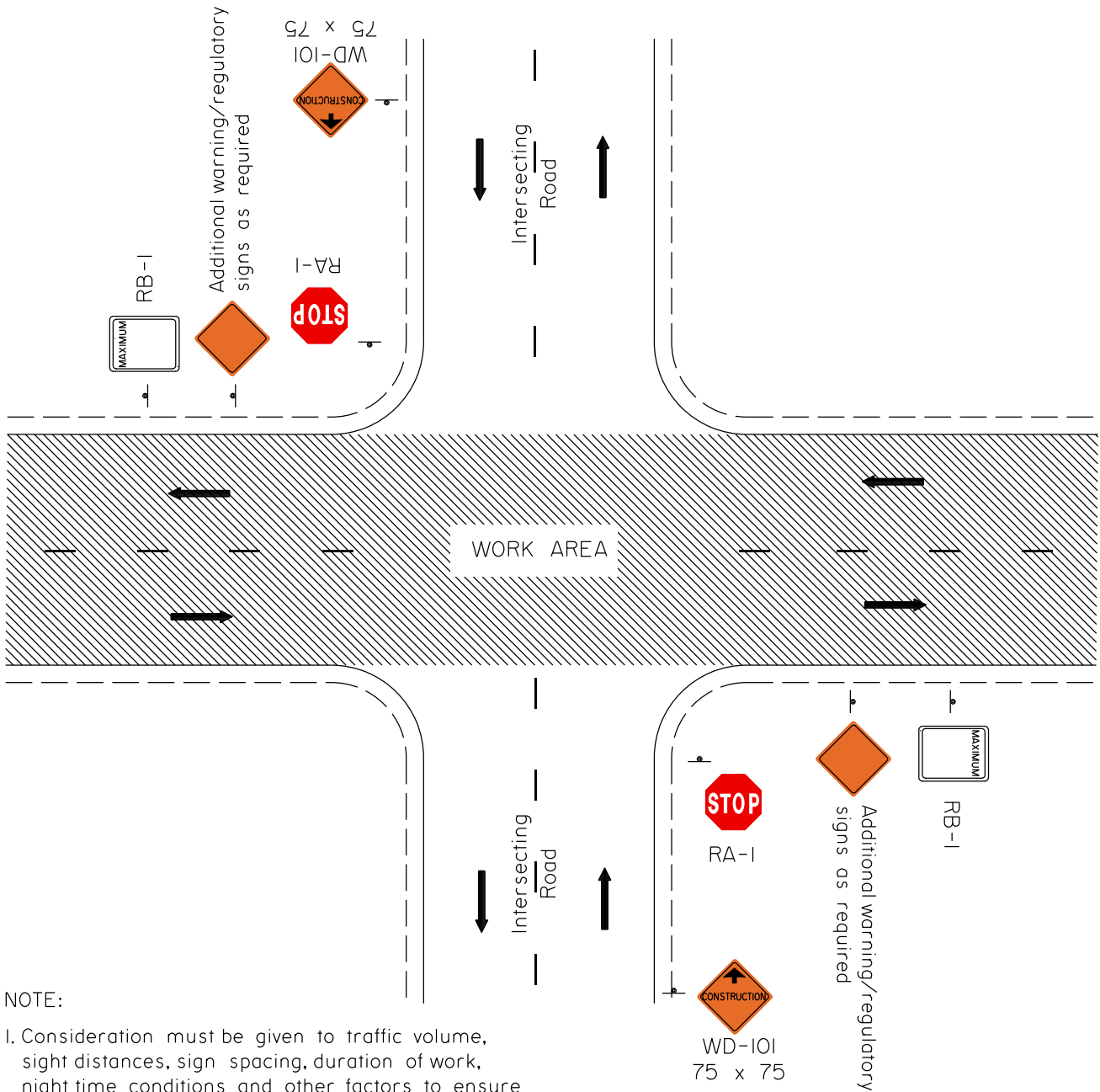

**NOTE:**

1. Consideration must be given to traffic volume, sight distances, sign spacing, duration of work, night time conditions and other factors to ensure traffic control devices are adequate in each instance.
2. All sign spacing shall be 100m-150m unless otherwise indicated.

	Title Block updated.	JM	Dec 31/07
No.	REVISIONS	BY	DATE
Approved:			
Original signed by Tim Hawnt			
Executive Director, Technical Standards Branch			
Date:	MARCH, 2001		
LONG DURATION - SIGNING INTERSECTING ROADS TWO LANE UNDIVIDED HIGHWAY			
Prepared By: G.E.C.	Checked By: P.H.	Scale: N.T.S.	Dwg No.: TCS-B-1,4A

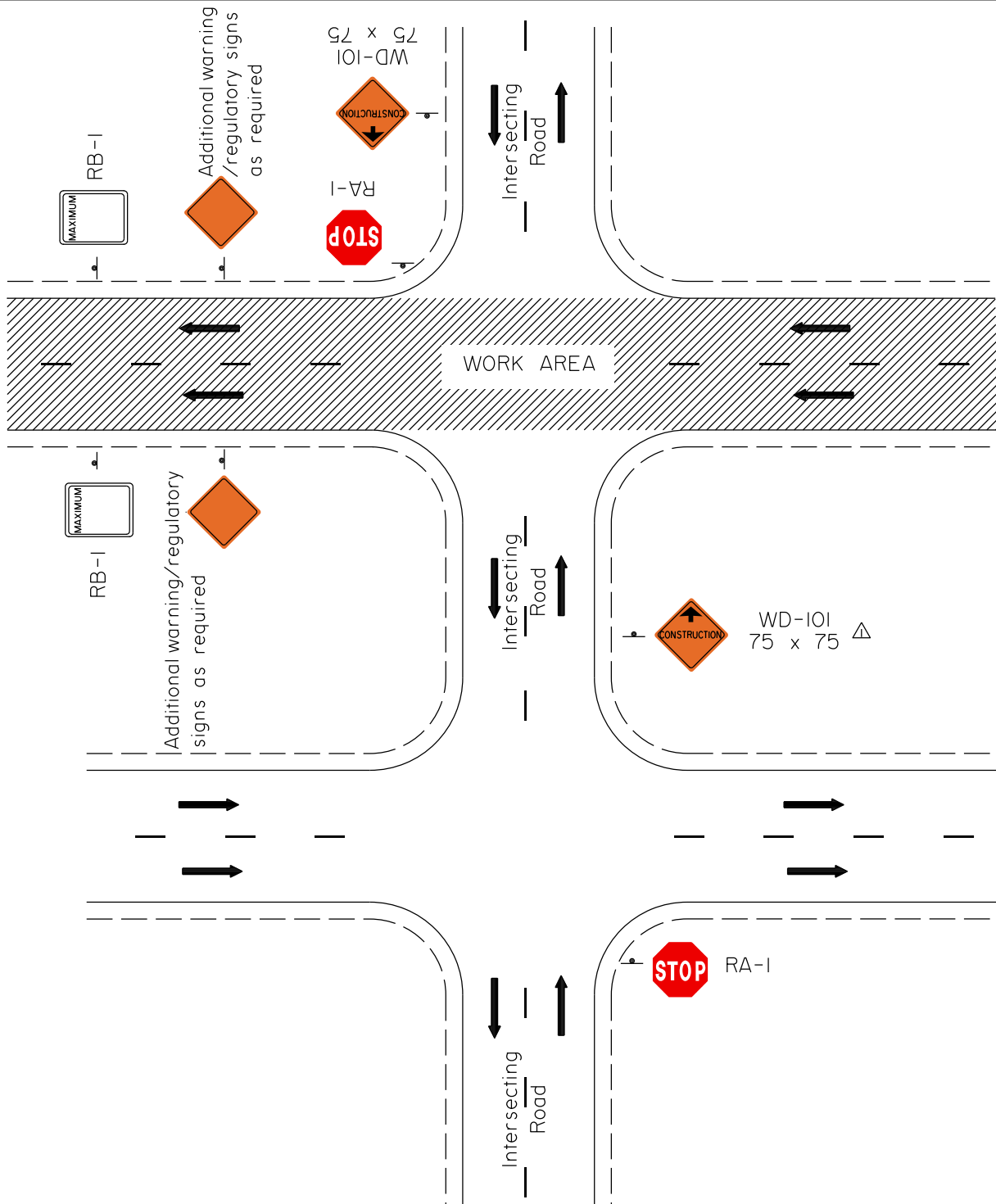

NOTE:

1. Consideration must be given to traffic volume, sight distances, sign spacing, duration of work, night time conditions and other factors to ensure traffic control devices are adequate in each instance.
2. All sign spacing shall be 100m-150m unless otherwise indicated.

△			
△			
△	Title Block updated and signs repositioned.	JM	Dec 31/07
No.	REVISIONS	BY	DATE
Approved:			
Original signed by Tim Hawnt			
Executive Director, Technical Standards Branch			
Date:	MARCH, 2001		
LONG DURATION - SIGNING △ INTERSECTING ROADS FOUR LANE DIVIDED HIGHWAY			
Prepared By: G.E.C.	Checked By: P.H.	Scale: N.T.S.	Dwg No.: TCS-B-1.4B

NOTES:

1. Consideration must be given to traffic volume, sight distances, sign spacing, duration of work, night time conditions and other factors to ensure traffic control devices are adequate in each instance.
2. All sign spacing shall be 100m-150m unless otherwise indicated.
3. Speed limit and warning signs shall be placed after every intersecting roadway and shall be no more than 5km apart throughout the work zone where there is a restricted speed zone.
4. During darkness two type "A" flashing lights shall be placed on top of each barricade.
5. A minimum lane width of 3.5m must be maintained.

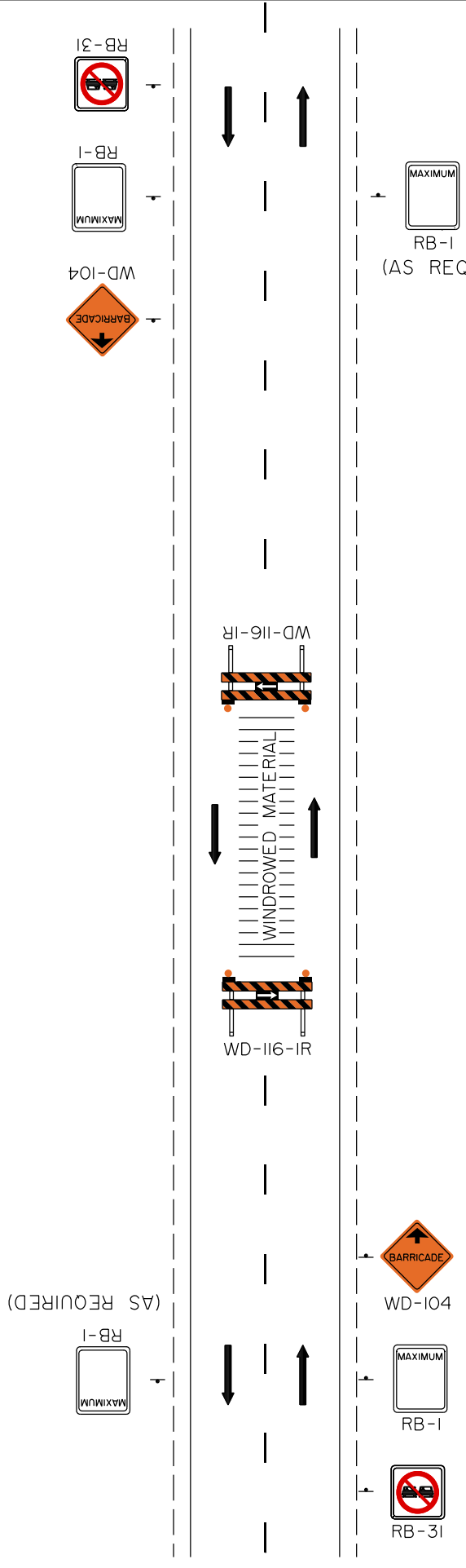

	Note and Title Block updated.	JM	Dec 31/07
No.	REVISIONS	BY	DATE
Approved:			
Original signed by Tim Hawnt			
Executive Director, Technical Standards Branch			
Date:	MARCH, 2001		
LONG DURATION - SIGNING			
OBSTRUCTION WITHIN WORK AREA			
TWO LANE UNDIVIDED HIGHWAY			
Prepared By: G.E.C.	Checked By: P.H.	Scale: N.T.S.	Dwg No.: TCS-B-1.5A

NOTES:

1. Consideration must be given to traffic volume, sight distances, sign spacing, duration of work, night time conditions and other factors to ensure traffic control devices are adequate in each instance.

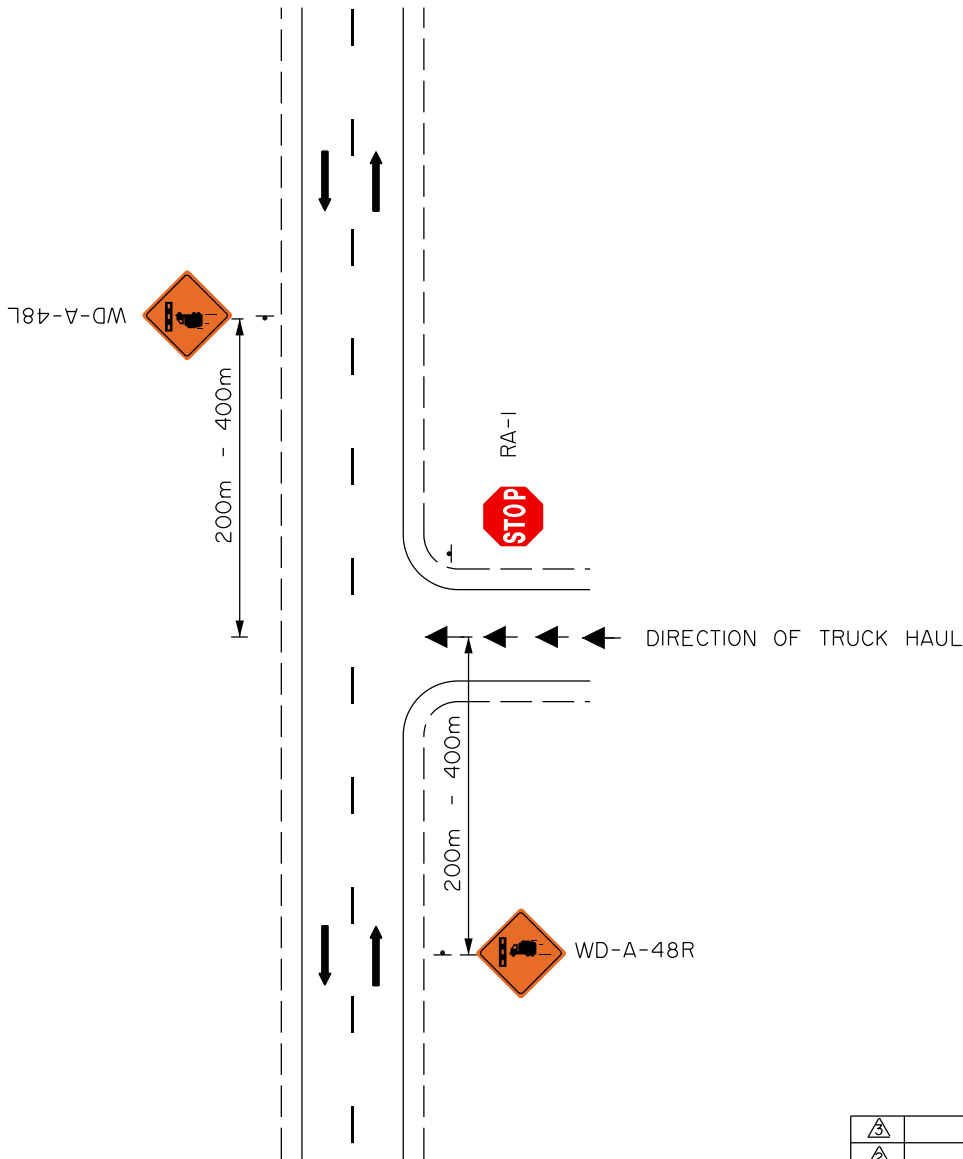

	Title Block updated.	JM	Dec 31/07
No.	REVISIONS	BY	DATE
Approved:			
Original signed by Tim Hawnt			
Executive Director, Technical Standards Branch			
Date:	MARCH, 2001		
LONG DURATION - SIGNING TRUCK ENTRANCE (HAUL ROUTE) TWO LANE UNDIVIDED HIGHWAY			
Prepared By: G.E.C.	Checked By: P.H.	Scale: N.T.S.	Dwg No.: TCS-B-1.6A

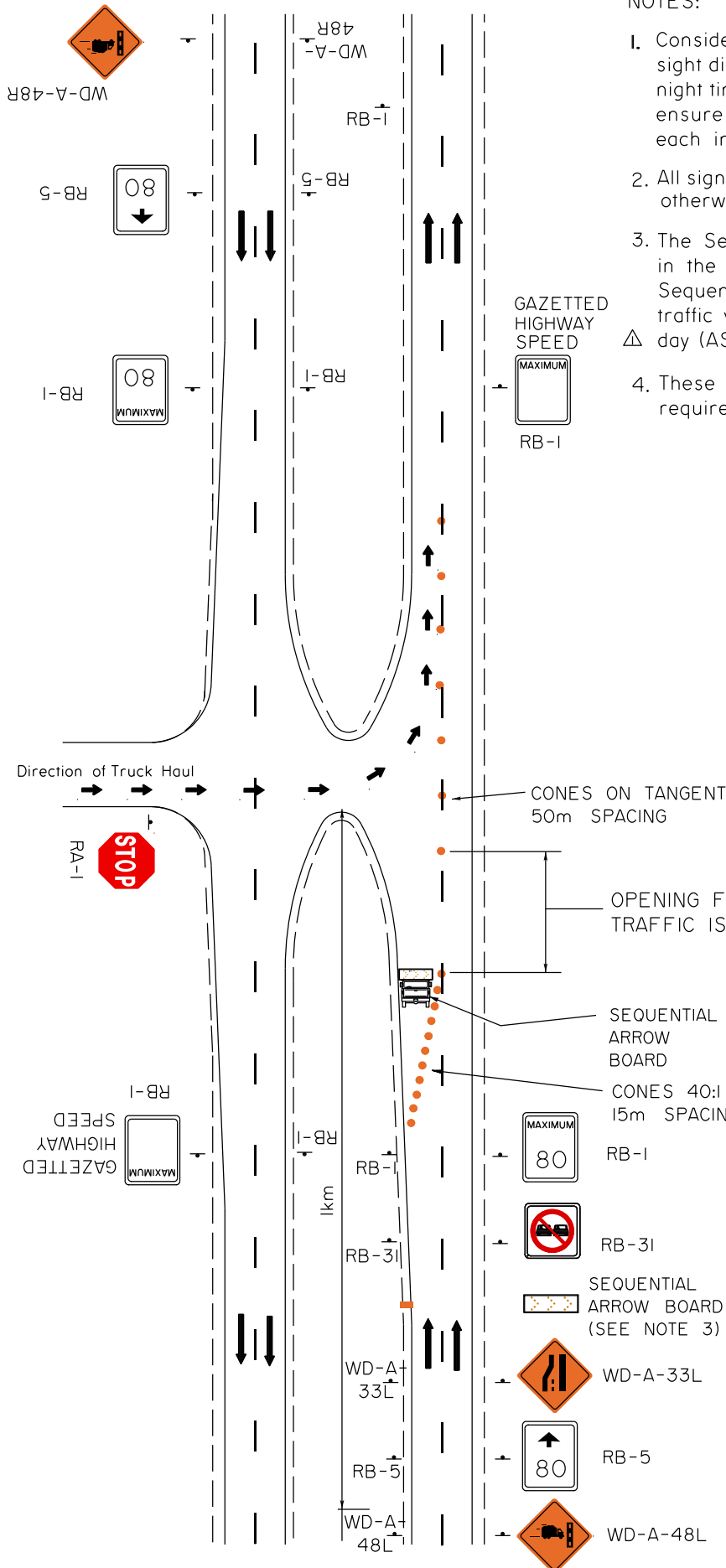

NOTES:

1. Consideration must be given to traffic volume, sight distances, sign spacing, duration of work, night time conditions and other factors to ensure traffic control devices are adequate in each instance.
2. All sign spacing shall be 100m-150m unless otherwise indicated.
3. The Sequential Arrow Board shall be located in the centre of the closed lane. An additional Sequential Arrow Board is required when traffic volume exceeds 10000 vehicles per day (ASDT) or when sight distance is restricted.
4. These signing details may not necessarily be required at all temporary truck entrances.

△			
△			
△	Note and Title Block updated.	JM	Dec 31/07
No.	REVISIONS	BY	DATE
Approved:			
Original signed by Tim Hawnt			
Executive Director, Technical Standards Branch			
Date:	MARCH, 2001		
LONG DURATION - SIGNING △ TRUCK ENTRANCE (HAUL ROUTE) FOUR LANE DIVIDED HIGHWAY			
Prepared By: G.E.C.	Checked By: P.H.	Scale: N.T.S.	Dwg No.: TSC-B-1.6B

NOTES:

1. Consideration must be given to traffic volume, sight distances, sign spacing, duration of work, night time conditions and other factors to ensure traffic control devices are adequate in each instance.
2. All sign spacing shall be 100m-150m unless otherwise indicated.
3. Speed limit/warning signs shall be placed after every intersecting roadway and shall be no more than 5km apart throughout the work zone where there is a restricted speed zone.
4. Temporary pavement marking requirement shall be as per specification.
5. WD-192 shall be erected 2km in advance of the project. Distance tab to include project length plus setback from project limit.

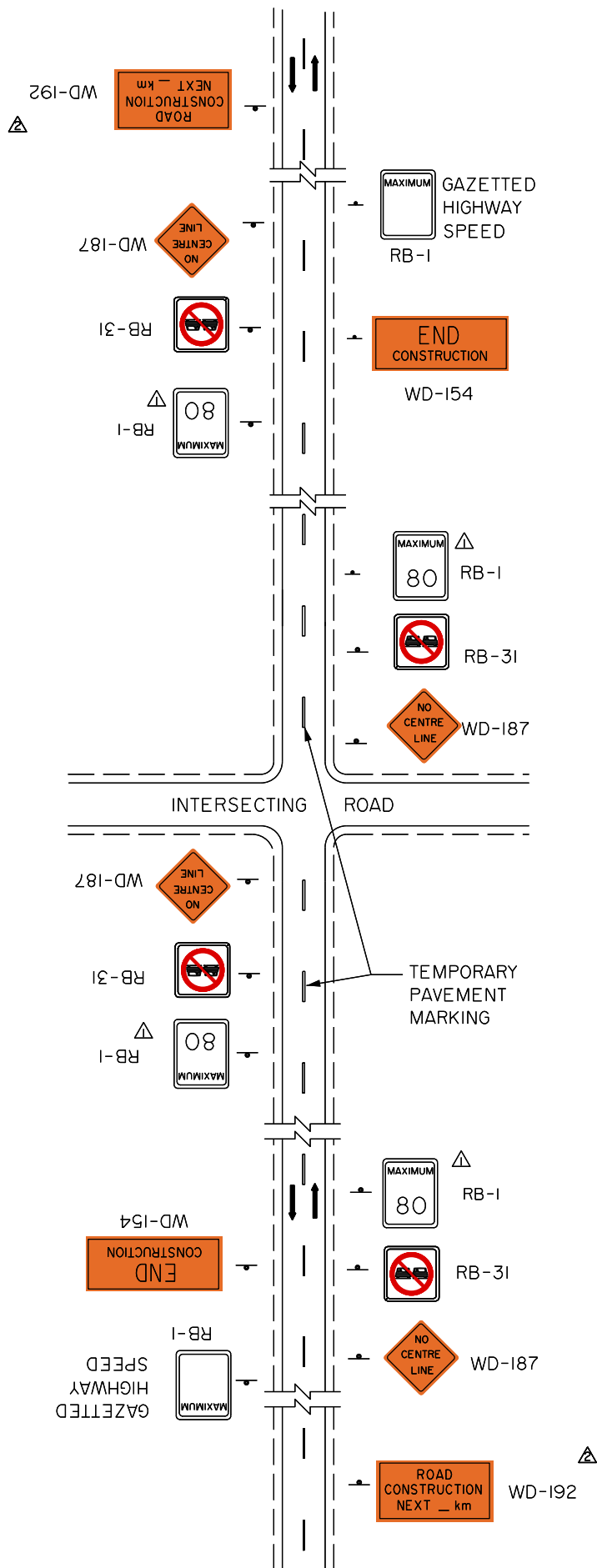

△			
△	Sign updated.	EY	Nov 30/18
△	80km/h added, Title Block and note updated.	JM	Dec 31/07
No.	REVISIONS	BY	DATE
Approved:			
Original signed by Tim Hawnt			
Executive Director, Technical Standards Branch			
Date:	MARCH, 2001		
LONG DURATION - SIGNING △			
NO CENTRE LINE PAVEMENT MARKING			
TWO LANE UNDIVIDED HIGHWAY			
Prepared By: G.E.C.	Checked By: P.H.	Scale: N.T.S.	Dwg No.: TCS-B-1.7A

NOTES:

1. Consideration must be given to traffic volume, sight distances, sign spacing, duration of work, night time conditions and other factors to ensure traffic control devices are adequate in each instance.
2. All sign spacing shall be 100m-150m unless otherwise indicated.
3. Speed limit/warning signs shall be placed after every intersecting roadway and shall be no more than 5km apart throughout the work zone where there is a restricted speed zone.
4. Temporary pavement marking requirement shall be as per specification.
5. WD-192 shall be erected 2km in advance of the project. Distance tab to include project length plus setback from project limit.

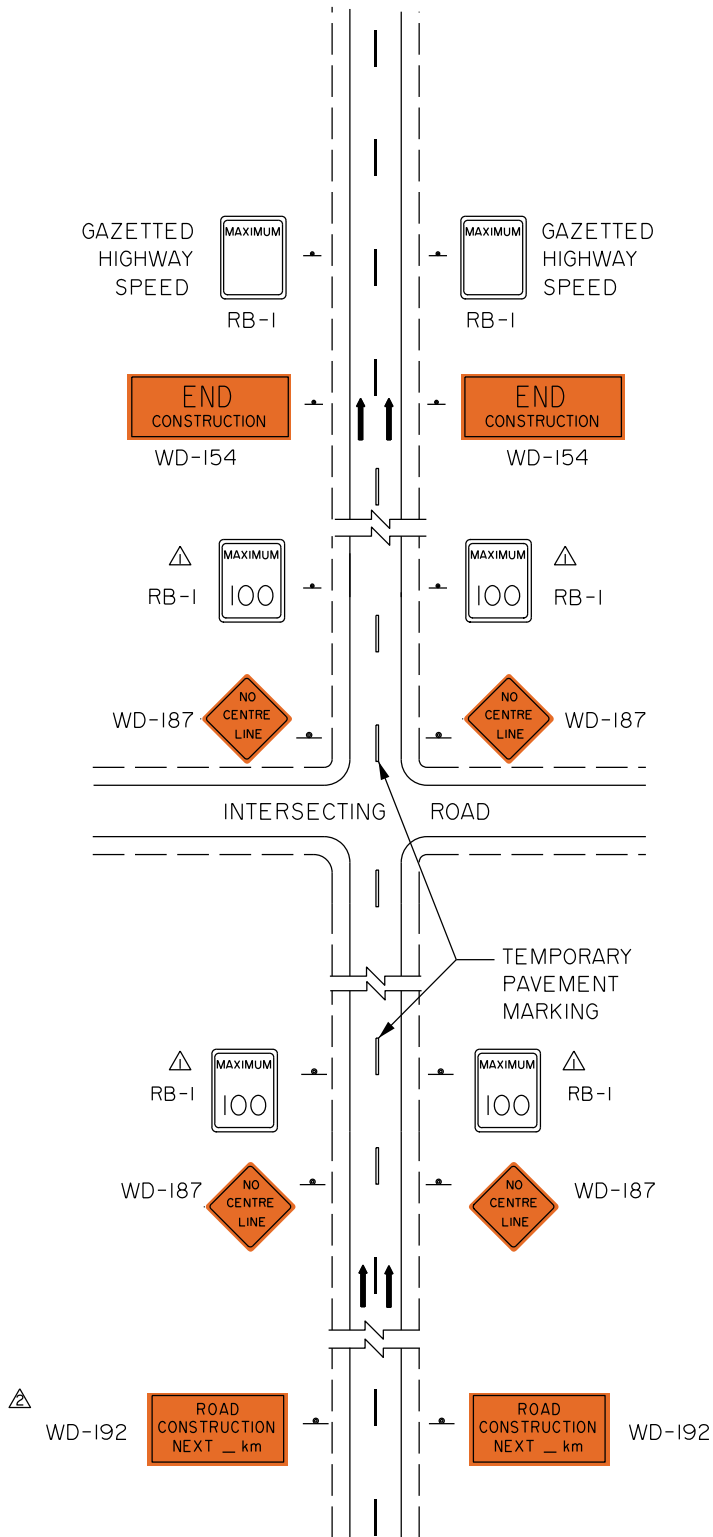

△			
△	Sign updated.	EY	Nov 30/18
△	00 km/h added, Title Block and note updated.	JM	Dec 31/07
No.	REVISIONS	BY	DATE
Approved:			
Original signed by Tim Hawnt			
Executive Director, Technical Standards Branch			
Date:	MARCH, 2001		
LONG DURATION - SIGNING △ NO CENTRE LINE PAVEMENT MARKING FOUR LANE DIVIDED HIGHWAY			
Prepared By: G.E.C.	Checked By: P.H.	Scale: N.T.S.	Dwg No.: TCS-B-1.7B



NOTES:

1. Consideration must be given to traffic volume, sight distances, sign spacing, duration of work, night time conditions and other factors to ensure traffic control devices are adequate in each instance.
2. All sign spacing shall be 100m-150m unless otherwise indicated.
3. For all detours, customised plans will be required.
4. Intersection control must be determined for each intersection on the detour route and must conform to appropriate legislation.
5. Detour speed limit must be appropriate for each detour route.
6. During darkness, two type "A" flashing lights shall be placed on top of each barricade.

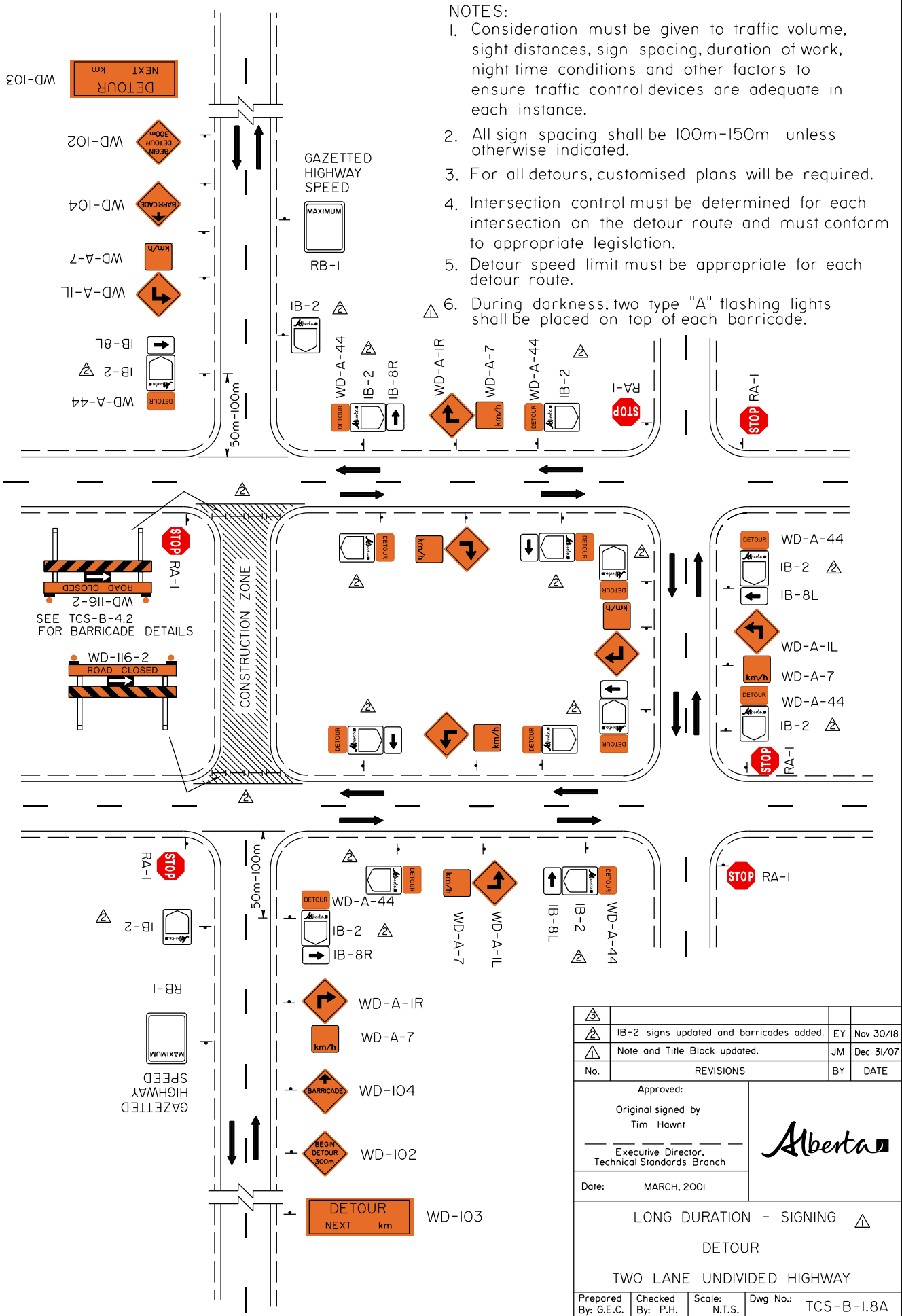

△			
△	IB-2 signs updated and barricades added.	EY	Nov 30/18
△	Note and Title Block updated.	JM	Dec 31/07
No.	REVISIONS	BY	DATE
Approved:			
Original signed by Tim Hawnt			
Executive Director, Technical Standards Branch			
Date:	MARCH, 2001		
LONG DURATION - SIGNING △ DETOUR TWO LANE UNDIVIDED HIGHWAY			
Prepared By: G.E.C.	Checked By: P.H.	Scale: N.T.S.	Dwg No.: TCS-B-1.8A

NOTES:

1. Consideration must be given to traffic volume, sight distances, sign spacing, duration of work, night time conditions and other factors to ensure traffic control devices are adequate in each instance.

2. All sign spacing shall be 100m-150m unless otherwise indicated.

3. Delineators with large bases at intervals of 20m.  
 △ If the drop-off has a slope flatter than 3:1, delineator posts may not be required.

4. During darkness, one type 'A' flashing light shall be placed on top of the barricade on the traffic side.  
 △

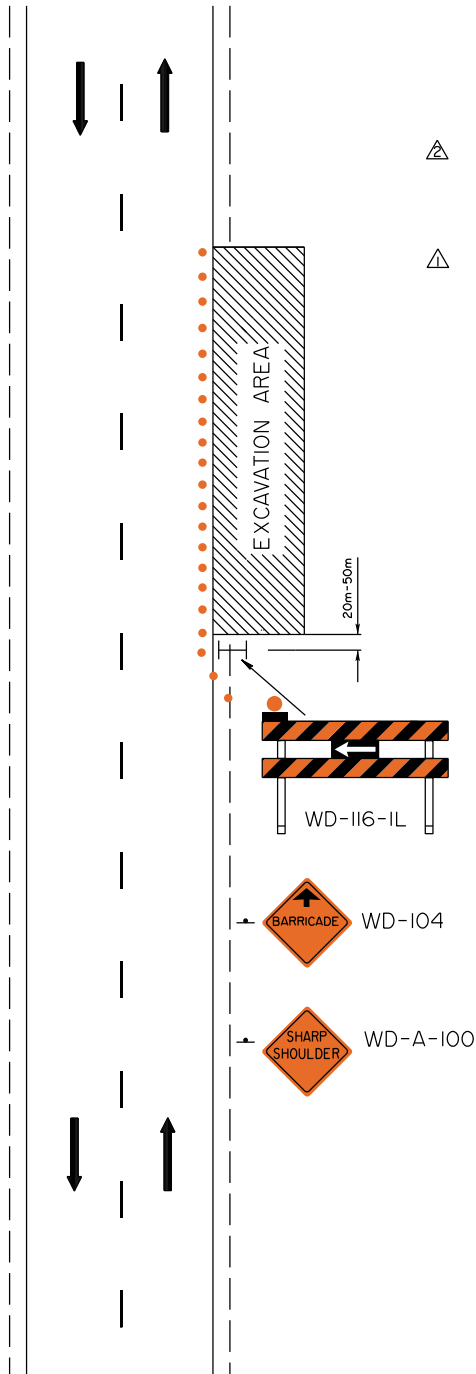

△			
△	Sign and notes updated.	EY	Nov 30/18
△	Note and Title Block updated.	JM	Dec 31/07
No.	REVISIONS	BY	DATE
Approved:			
Original signed by Tim Hawnt			
Executive Director, Technical Standards Branch			
Date:	MARCH, 2001		
LONG DURATION - SIGNING △ SHOULDER DROP-OFF (WITHIN WORK ZONE) TWO LANE UNDIVIDED HIGHWAY			
Prepared By: G.E.C.	Checked By: P.H.	Scale: N.T.S.	Dwg No.: TCS-B-1.9A

NOTES:

1. Consideration must be given to traffic volume, sight distances, sign spacing, duration of work, night time conditions and other factors to ensure traffic control devices are adequate in each instance.
2. All sign spacing shall be 100m-150m unless otherwise indicated.
3. During darkness, one type 'A' flashing light shall be placed on top of each barricade on the traffic side.

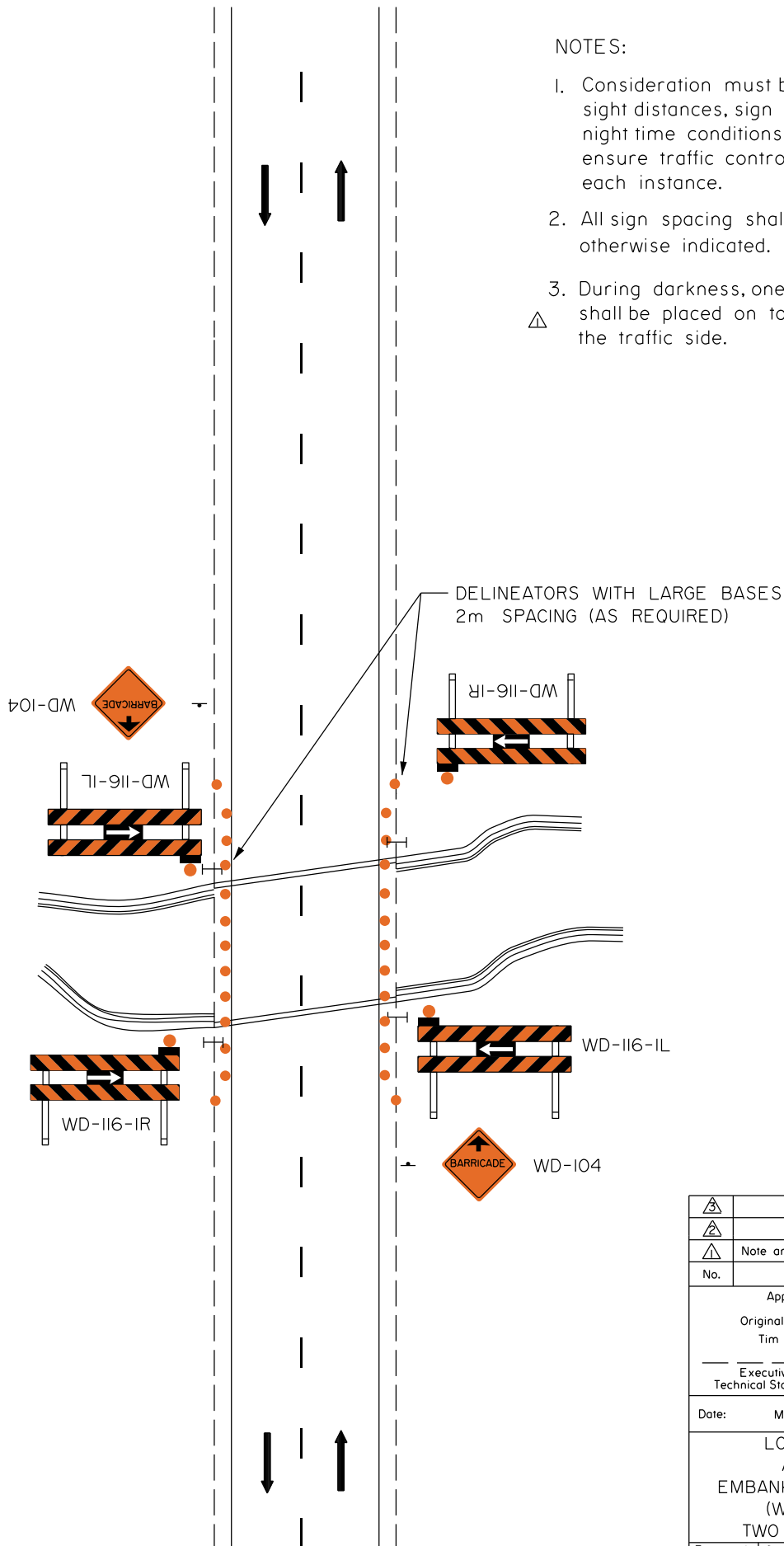

△			
△			
△	Note and Title Block updated.	JM	Dec 31/07
No.	REVISIONS	BY	DATE
Approved:			
Original signed by Tim Hawnt			
Executive Director, Technical Standards Branch			
Date:	MARCH, 2001		
LONG DURATION - SIGNING △ AND DELINEATION FOR EMBANKMENTS AND FIXED OBJECTS (WITHIN THE WORK ZONE) TWO LANE UNDIVIDED HIGHWAY			
Prepared By: G.E.C.	Checked By: P.H.	Scale: N.T.S.	Dwg No.: TCS-B-1.IIA

NOTES:

1. Consideration must be given to traffic volume, sight distances, sign spacing, duration of work, night time conditions and other factors to ensure traffic control devices are adequate in each instance.
2. All sign spacing shall be 100m-150m unless otherwise indicated.
3. During darkness, one type 'A' flashing light shall be placed on top of each barricade on the traffic side.

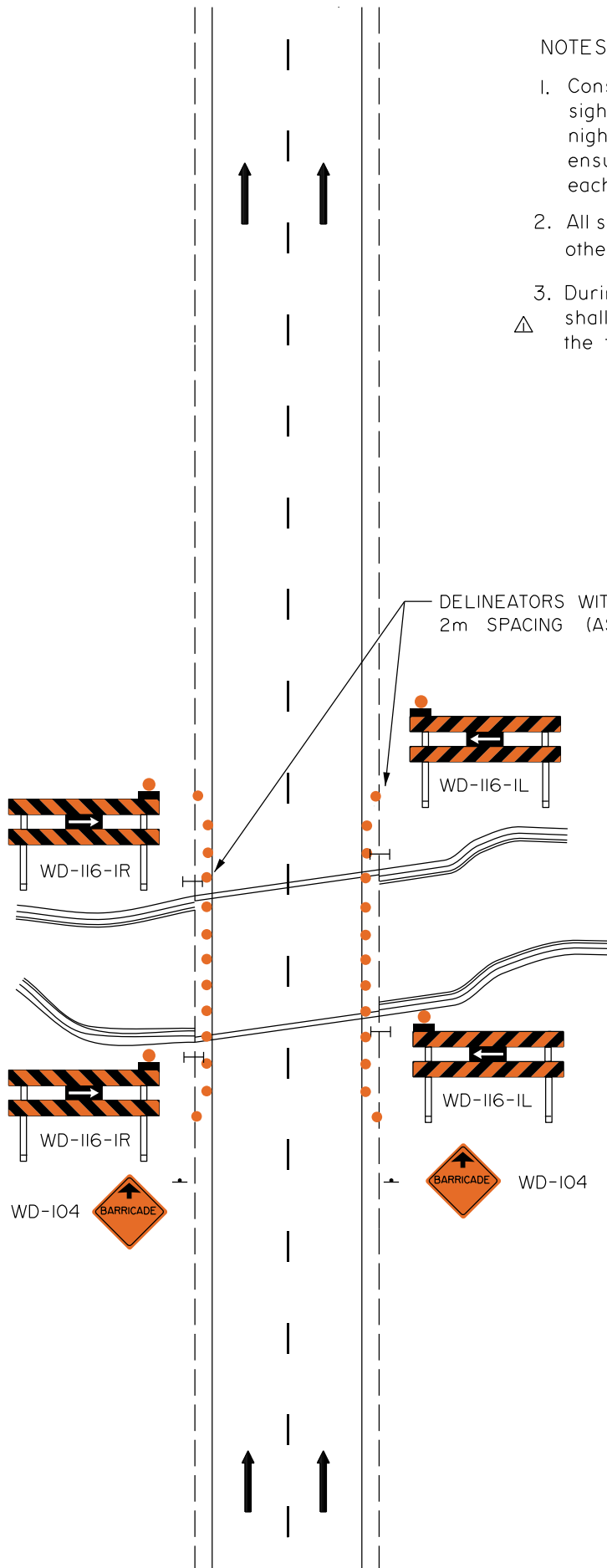

	Note and Title Block updated.	JM	Dec 31/07
No.	REVISIONS	BY	DATE
Approved:			
Original signed by Tim Hawnt			
Executive Director, Technical Standards Branch			
Date:	MARCH, 2001		
LONG DURATION - SIGNING AND DELINEATION FOR EMBANKMENTS AND FIXED OBJECTS (WITHIN THE WORK ZONE) FOUR LANE DIVIDED HIGHWAY			
Prepared By: G.E.C.	Checked By: P.H.	Scale: N.T.S.	Dwg No.: TCS-B-1.IIB

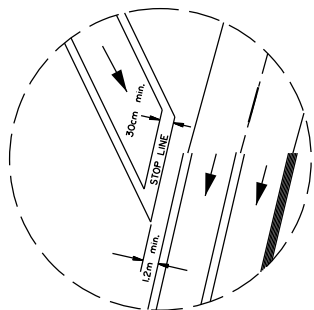

DETAIL 'A'

NOTES:

1. Consideration must be given to traffic volume, sight distances, sign spacing, duration of work, night time conditions and other factors to ensure traffic control devices are adequate in each instance.
2. All sign spacing shall be 100m-150m unless otherwise indicated.
3. Conflicting lane markings must be removed.
4. See other typical drawings for advance signing.
5. During darkness, one type 'A' flashing lights shall be placed on top of each barricade on the traffic side.
6. Use of Sequential Arrow Board and Electronic Message Board as required.

— LEGEND —

TEMPORARY PAVEMENT MARKING DETAILS	
	YELLOW EDGE LINES FOR CRITICAL AREAS WHERE CROSSING IS PROHIBITED
	WHITE EDGE LINES AND LANE DIVIDING LINES PROHIBITING LANE CHANGE

- DELINEATOR POSTS WITH LARGE BASES
- |— BARRICADES
- LARGE CONES

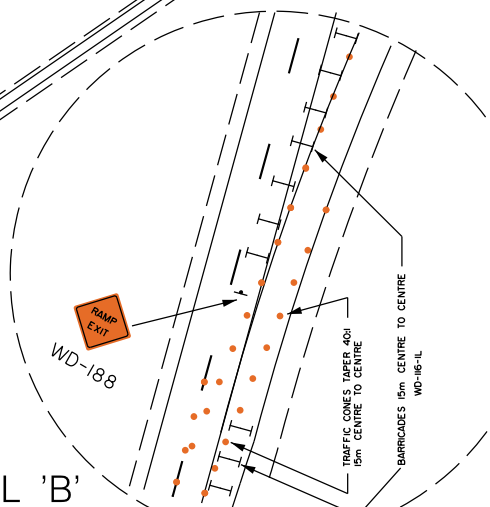
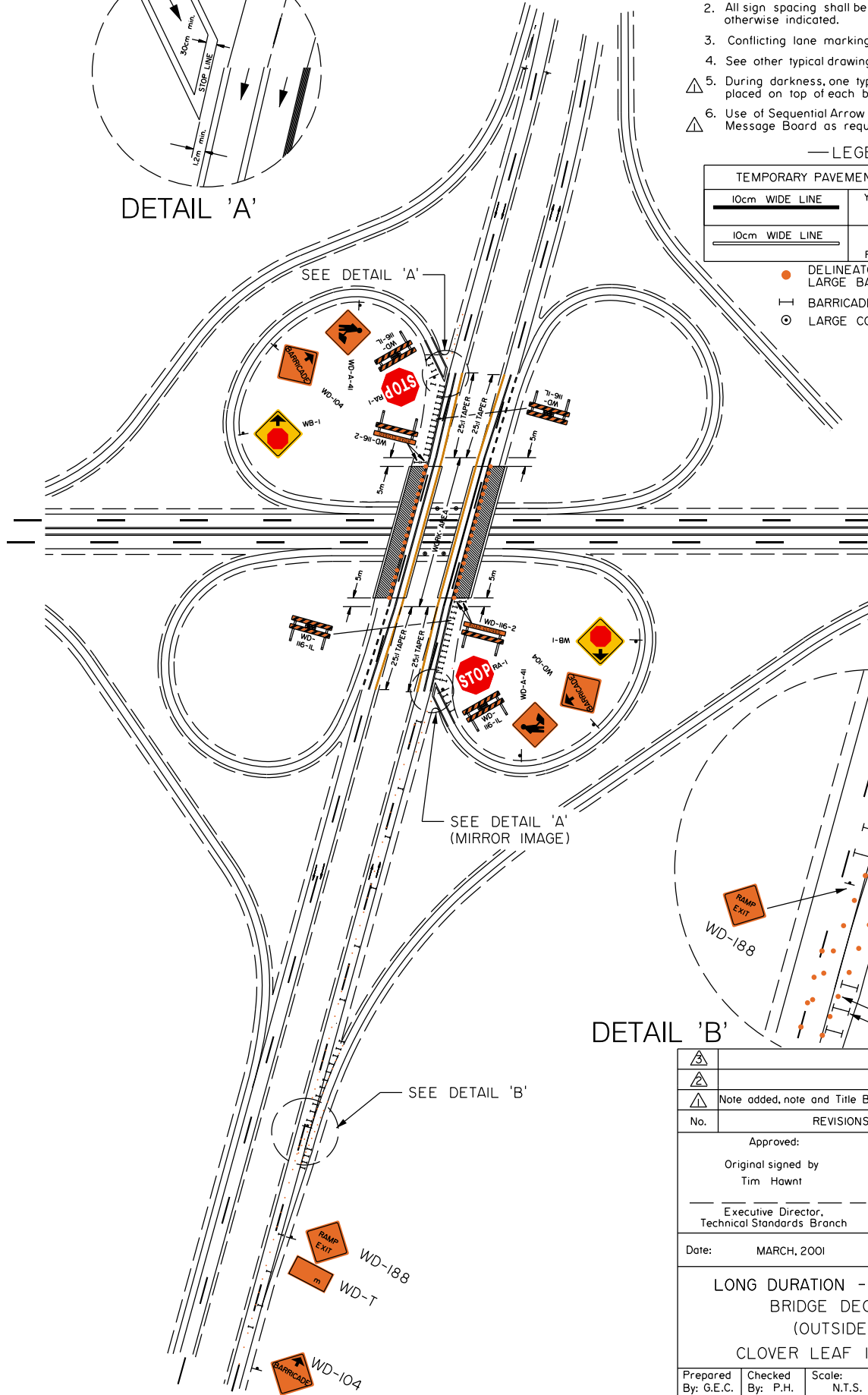



DETAIL 'B'



	Note added, note and Title Block updated.	JM	Dec 31/07
No.	REVISIONS	BY	DATE
Approved:			
Original signed by Tim Hawnt			
Executive Director, Technical Standards Branch			
Date:	MARCH, 2001		
LONG DURATION - BRIDGE SIGNING			
BRIDGE DECK REPAIR			
(OUTSIDE LANE)			
CLOVER LEAF INTERCHANGES			
Prepared By: G.E.C.	Checked By: P.H.	Scale: N.T.S.	Dwg No.: TCS-B-1.15B

NOTES:

1. Consideration must be given to traffic volume, sight distances, sign spacing, duration of work, night time conditions and other factors to ensure traffic control devices are adequate in each instance.
2. All sign spacing shall be 100m-150m unless otherwise indicated.
3. Conflicting lane markings must be removed.
4. See other typical drawings for advance signing.
5. During darkness, one type 'A' flashing lights shall be placed on top of each barricade on the traffic side.
6. Use of Sequential Arrow Board and Electronic Message Board as required.



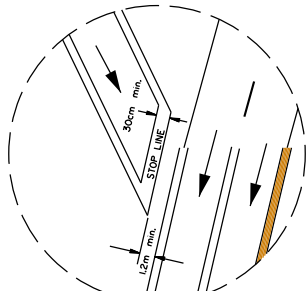
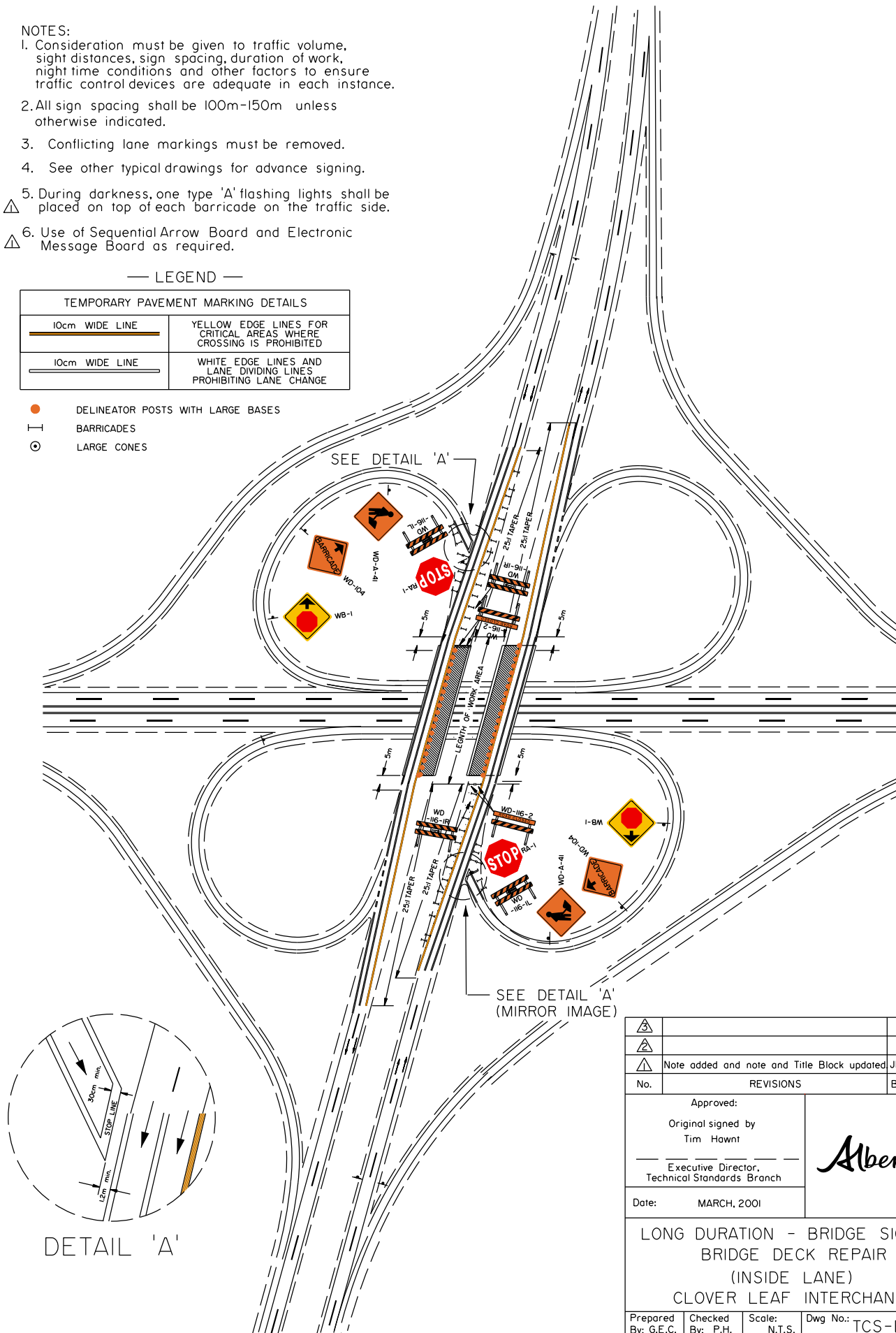

— LEGEND —

TEMPORARY PAVEMENT MARKING DETAILS	
	YELLOW EDGE LINES FOR CRITICAL AREAS WHERE CROSSING IS PROHIBITED
	WHITE EDGE LINES AND LANE DIVIDING LINES PROHIBITING LANE CHANGE

-  DELINEATOR POSTS WITH LARGE BASES
-  BARRICADES
-  LARGE CONES



DETAIL 'A'

			
			
	Note added and note and Title Block updated	JM	Dec 31/07
No.	REVISIONS	BY	DATE
Approved:			
Original signed by Tim Hawnt			
Executive Director, Technical Standards Branch			
Date:	MARCH, 2001		
LONG DURATION - BRIDGE SIGNING BRIDGE DECK REPAIR  (INSIDE LANE) CLOVER LEAF INTERCHANGES			
Prepared By: G.E.C.	Checked By: P.H.	Scale: N.T.S.	Dwg No.: TCS-B-1.16B

NOTE:  
 DETAILS OF  
 WARNING/REGULATORY  
 SIGNS SAME AS  
 THOSE ON OTHER  
 SIDE OF HIGHWAY.

CONES 5:1 TAPER  
 5 CONES MINIMUM

WD-173  
 PILOT VEHICLE  
 DO NOT PASS  
 INSTALL ON REAR OF  
 PILOT VEHICLE

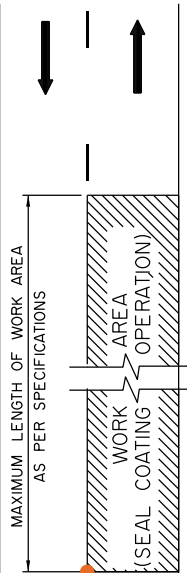

RB-1  
 MAXIMUM  
 GAZETTED  
 HIGHWAY  
 SPEED

END  
 CONSTRUCTION  
 WD-154

MAXIMUM  
 LOOSE  
 CHIPS  
 WD-174

SEE NOTE 8  
 MAXIMUM  
 LOOSE  
 CHIPS  
 WD-174

LOOSE CHIPS  
 PLEASE  
 SLOW DOWN  
 WD-169  
 INSTALL EVERY 4.8km

FOLLOW  
 PILOT  
 VEHICLE  
 WD-172

FOLLOW IN  
 CONVOY  
 DO NOT  
 PASS  
 WD-171

TRAFFIC CONTROL PERSON

WD-A-21

MAXIMUM  
 50  
 RB-1

RB-31

ONE LANE  
 TRAFFIC  
 WD-106

50  
 RB-5

VARIABLE MESSAGE  
 (SEE NOTE 4)

WD-A-41

CONSTRUCTION  
 WD-101

ROAD  
 CONSTRUCTION  
 NEXT \_ km  
 WD-192

NOTES:

1. Consideration must be given to traffic volume, direction of travel of seal coating operations, sight distances, sign spacing, duration of work and other factors to ensure traffic control devices are adequate in each instance.
2. All sign spacing shall be 100m-150m unless otherwise indicated.
3. Typical signing is required in both directions.
4. Variable Message Board should read either "LOOSE CHIPS MAX 50 km/h" or "LOOSE CHIPS PLEASE SLOW DOWN".
5. WD-192 shall be erected 2km in advance of the project. Distance tab to include project length plus setback from project limit.
6. Drawing TCS-B-1.7A applies when construction on the roadway has been completed but barrier lines have not yet been painted.
7. Conditions under which 'MAXIMUM 80km/hr' sign may be used are detailed in the chip seal coat specifications.
8. Speed limit signs shall be placed after every intersecting roadway and shall be no more than 5 km apart.

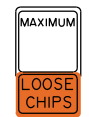

BLACK ON WHITE

BLACK ON ORANGE

WD-174 (speed limit shown on WD-174 should be compatible with other speed limit signs used)

△			
△	Signs updated.	EY	Nov 30/18
△	Title Block updated, changed Taper to 5:1, pilot vehicle updated and note added.	JM	Dec 31/07
No.	REVISIONS	BY	DATE
Approved:			
Original signed by Tim Hawnt			
Executive Director, Technical Standards Branch			
Date:	MARCH, 2001		
LONG DURATION - SIGNING △ CHIP SEAL COATING OPERATIONS TWO LANE UNDIVIDED HIGHWAY			
Prepared By: G.E.C.	Checked By: P.H.	Scale: N.T.S.	Dwg No.: TCS-B-1.17A

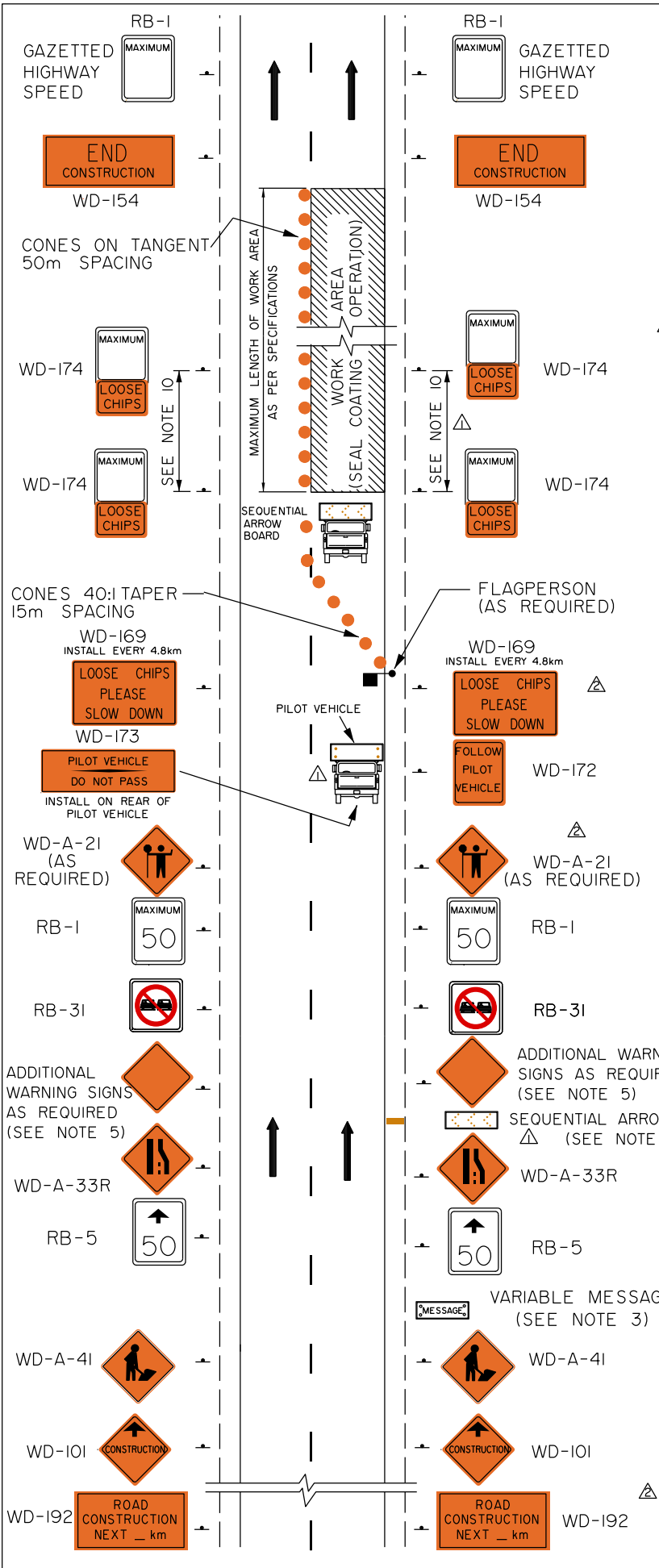

**NOTES:**

1. Consideration must be given to traffic volume, direction of travel of seal coating operations, sight distances, sign spacing, duration of work and other factors to ensure traffic control devices are adequate in each instance.
2. All sign spacing shall be 100m-150m unless otherwise indicated.
3. Variable Message Board message should read either "LOOSE CHIPS MAX 50 km/h" or "LOOSE CHIPS PLEASE SLOW DOWN".
4. An additional Sequential Arrow Board is required when traffic volumes exceed 10000 vehicles per day (ASDT) or when sight distance is restricted.
5. Examples of additional warning signs that may be required in conjunction with this plan are:
  - 
  - 
  -
6. WD-192 shall be erected 2km in advance of the project. Distance tab to include project length plus setback from project limit.
7. Drawing TCS-B-1.7B applies when construction on the roadway has been completed but barrier lines have not yet been painted.
8. Conditions under which 'MAXIMUM 80km/hr' sign may be used are detailed in the chip seal coat specifications.
9. Cones on tangent may not be required if alternative lane closure methods are utilized.
10. Speed limit signs shall be placed after every intersecting roadway and shall be no more than 5 km apart.

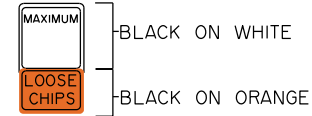

WD-174 (speed limit shown on WD-174 should be compatible with other speed limit signs used)

	Signs updated.	EY	Nov 30/18
	Note and Title Block updated, pilot vehicle revision and note added.	JM	Dec 31/07
No.	REVISIONS	BY	DATE
Approved:			
Original signed by Tim Hawnt			
Executive Director, Technical Standards Branch			
Date:	MARCH, 2001		
LONG DURATION - SIGNING			
CHIP SEAL COATING OPERATIONS			
FOUR LANE DIVIDED HIGHWAY			
Prepared By: G.E.C.	Checked By: P.H.	Scale: N.T.S.	Dwg No.: TCS-B-1.17B





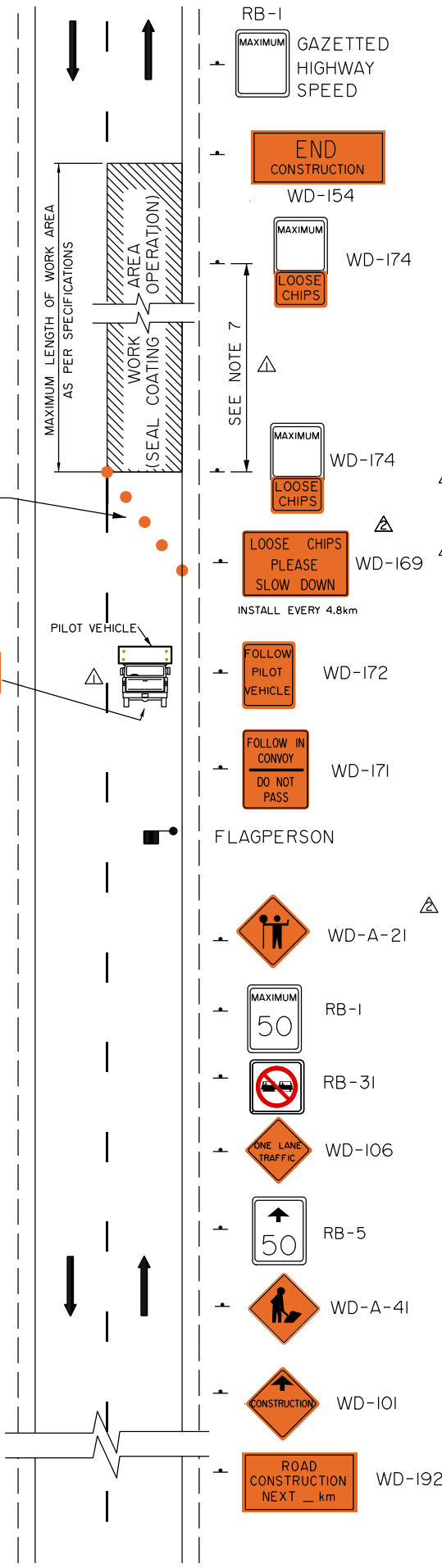

NOTE:  
 DETAILS OF  
 WARNING/REGULATORY  
 SIGNS SAME AS  
 THOSE ON OTHER  
 SIDE OF HIGHWAY.



- NOTES:
1. Consideration must be given to traffic volume, direction of travel of seal coating operations, sight distances, sign spacing, duration of work and other factors to ensure traffic control devices are adequate in each instance.
  2. All sign spacing shall be 100m-150m unless otherwise indicated.
  3. Typical signing is required in both directions.
  4. WB-192 shall be erected 2km in advance of the project. Distance tab to include project length plus setback from project limit.
  5. Drawing TCS-B-1.7A applies when construction on the roadway has been completed but barrier lines have not yet been painted.
  6. Conditions under which 'MAXIMUM 80km/hr' sign may be used are detailed in the double seal coating operations specifications.
  7. Speed limit signs shall be placed after every intersecting roadway and shall be no more than 5 km apart.

 BLACK ON WHITE  
 BLACK ON ORANGE  
 WB-174 (speed limit shown on WB-174 should be compatible with other speed limit signs used)

			
	Signs updated.	EY	Nov 30/18
	Note and Title Block updated, taper changed to 5:1, pilot vehicle revision and note added.	JM	Dec 31/07
No.	REVISIONS	BY	DATE
Approved:			
Original signed by Tim Hawnt			
Executive Director, Technical Standards Branch			
Date:	MARCH, 2001		
LONG DURATION - SIGNING  DOUBLE SEAL AND GRADED AGGREGATE SEAL COATING OPERATIONS TWO LANE UNDIVIDED HIGHWAY			
Prepared By: G.E.C.	Checked By: P.H.	Scale: N.T.S.	Dwg No.: TCS-B-1.18A

**NOTES:**

1. Consideration must be given to traffic volume, sight distances, sign spacing, duration of work, night time conditions and other factors to ensure traffic control devices are adequate in each instance.
2. All sign spacing shall be 100m-150m unless otherwise indicated.
3. Shoulder delineation is required on 8m spacing along the length of the detour (both sides).
4. For paved detours, line painting or temporary lane markings are required.
5. For gravel detours, temporary lane markings are required to transition painted line markings from the paved surface.
6. Conflicting lane markings shall be removed.
7. Detour shall be designed and illuminated according to Highway Geometric Design Guide, Section B.7 Temporary Highway Detours.
8. Temporary traffic barriers shall be Approved Continuous Precast Concrete F-shaped Barriers (refer to Alberta Transportation's Roadside Design Guide for the latest drawing CB6-4.2MI6 or approved equivalent) meeting the requirements of NCHRP 350 Test Level 3, with proper consideration for deflection allowance behind barriers. The barriers shall be placed on pavement or properly prepared granular base.
9. The exposed ends of the barriers shall be protected by crash attenuators on Alberta Transportation's product list. If sand barrels are considered, it must be approved by the department (refer to Roadside Design Guide for the latest drawing TEB 3.19).
10. Alternatively, the barriers may be terminated outside the clear zone (refer to drawing TCS-B-1.29).

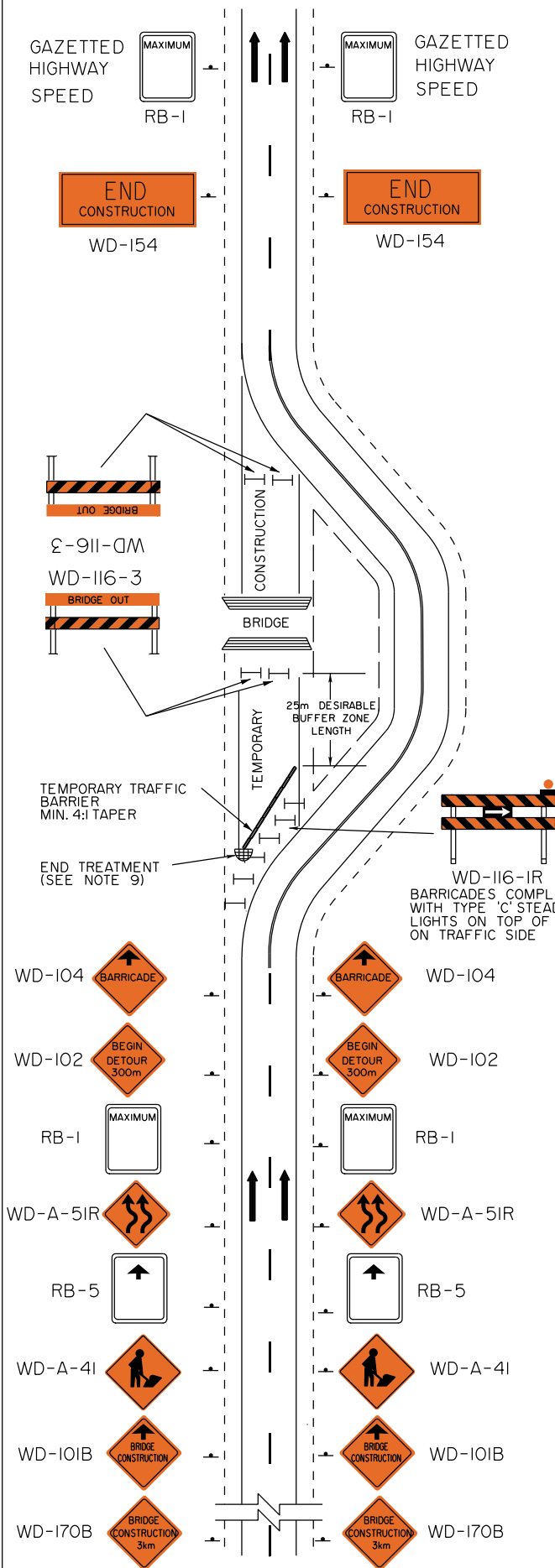

△			
△	Notes updated.	EY	Nov 30/18
△	Notes and Title Block updated.	JM	Sep 23/08
No.	REVISIONS	BY	DATE
Approved:			
Original Signed by Allan Kwan			
Executive Director, Technical Standards Branch			
Date:	JANUARY 2005		
LONG DURATION - BRIDGE DETOUR SIGNING (WORK ZONE SPEED > 60 km/h) △			
FOUR LANE DIVIDED HIGHWAY			
Prepared By: S.L.	Checked By: J.T.	Scale: N.T.S.	Dwg No.: TCS-B-1.19B

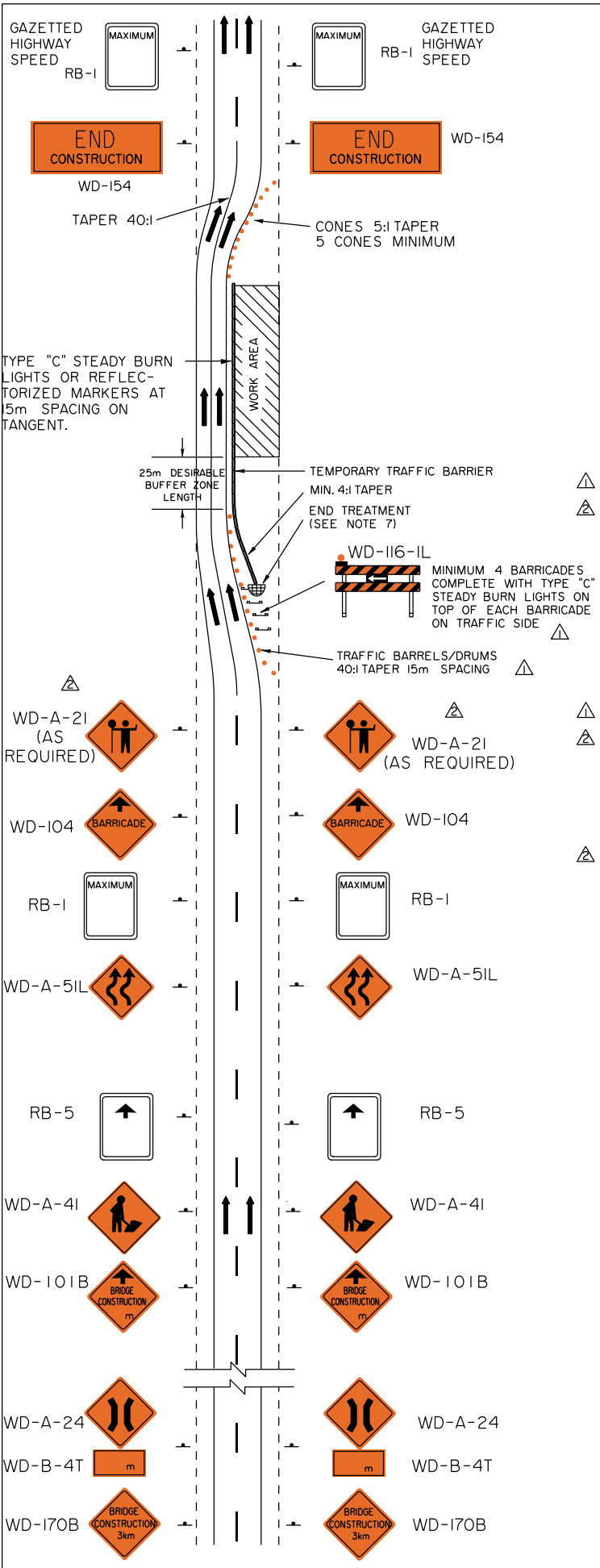

**NOTES:**

1. Consideration must be given to traffic volume, sight distances, sign spacing, duration of work, night time conditions and other factors to ensure traffic control devices are adequate in each instance.
2. When switching traffic during staged construction, a specialized traffic accommodation plan is required.
3. All sign spacing shall be 100m-150m unless otherwise indicated
4. A minimum lane width of 3.5m is required.
5. Temporary lane markings are required and conflicting lane markings shall be removed.
6. Temporary traffic barriers shall be Approved Continuous Precast Concrete F-shaped Barriers (refer to Alberta Transportation's Roadside Design Guide for the latest drawing CB6-4.2M16 or approved equivalent) meeting the requirements of NCHRP 350 Test Level 3, with proper consideration for deflection allowance behind barriers. The barriers shall be placed on pavement or properly prepared granular base.
7. The exposed ends of the barriers shall be protected by crash attenuators on Alberta Transportation's product list. If sand barrels are considered, it must be approved by the department (refer to Roadside Design Guide for the latest drawing TEB 3.19).
8. Alternatively, the barriers may be terminated outside the clear zone (refer to drawing TCS-B-1.29).

△			
△	Notes and signs updated.	EY	Nov 30/18
△	Notes and Title Block updated.	JM	Sep 23/08
No.	REVISIONS	BY	DATE
Approved:			
Original Signed by Allan Kwan			
Executive Director, Technical Standards Branch			
Date:	JANUARY 2005		
LONG DURATION - BRIDGE SIGNING (WORK ZONE SPEED > 60 km/h OR WORK AREA > 300mm DROP) △			
TWO LANES TRAFFIC (REDUCED BRIDGE WIDTH) FOUR LANE DIVIDED HIGHWAY			
Prepared By: S.L.	Checked By: J.T.	Scale: N.T.S.	Dwg No.: TCS-B-1.20B

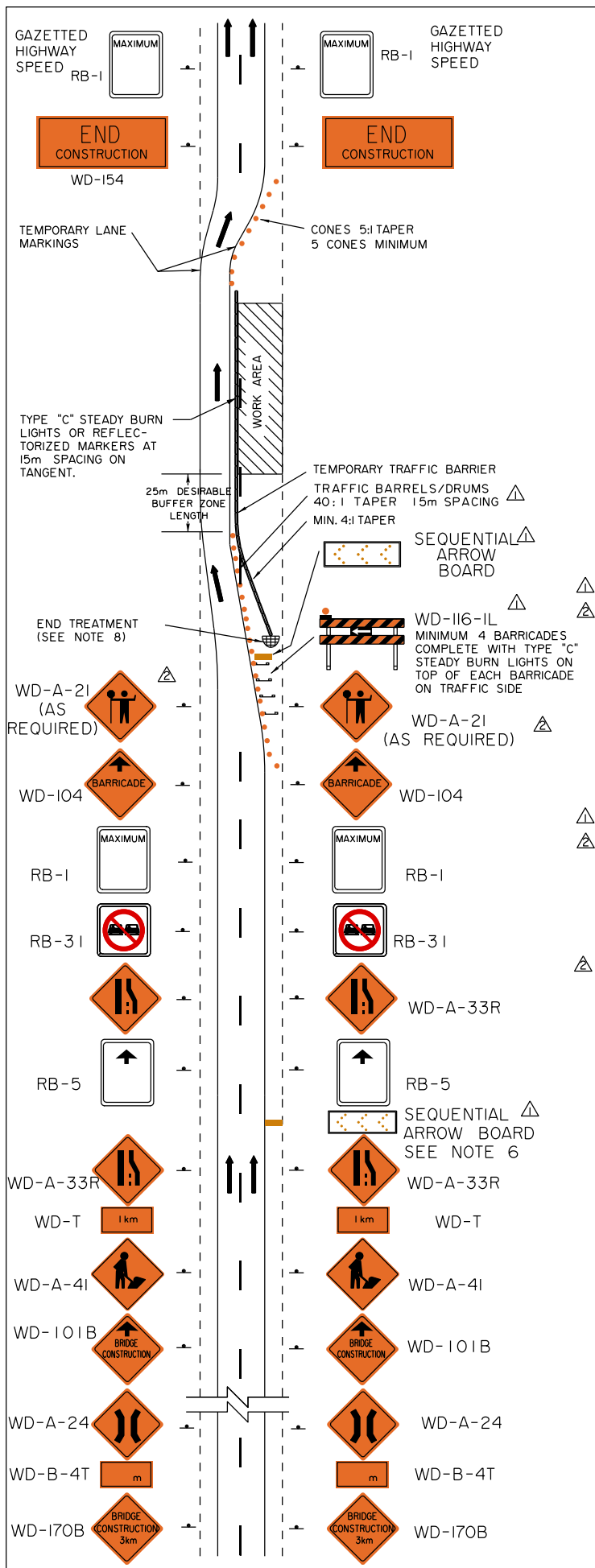

NOTES:

1. Consideration must be given to traffic volume, sight distances, sign spacing, duration of work, night time conditions and other factors to ensure traffic control devices are adequate in each instance.
2. When switching traffic during staged construction, a specialized traffic accommodation plan is required.
3. All sign spacing shall be 100m-150m unless otherwise indicated.
4. A minimum lane width of 3.5m is required.
5. Temporary lane markings are required and conflicting lane markings shall be removed.
6. The Sequential Arrow Board shall be located in the centre of the closed lane. An additional Sequential Arrow Board is required when traffic volumes exceed 10000 vehicles per day (ASDT) or when sight distance is restricted.
7. Temporary traffic barriers shall be Approved Continuous Precast Concrete F-shaped Barriers (refer to Alberta Transportation's Roadside Design Guide for the latest drawing CB6-4.2MI6 or approved equivalent) meeting the requirements of NCHRP 350 Test Level 3, with proper consideration for deflection allowance behind barriers. The barriers shall be placed on pavement or properly prepared granular base.
8. The exposed ends of the barriers shall be protected by crash attenuators on Alberta Transportation's product list. If sand barrels are considered, it must be approved by the department (refer to Roadside Design Guide for the latest drawing TEB 3.19).
9. Alternatively, the barriers may be terminated outside the clear zone (refer to drawing TCS-B-1.29).

	Notes and signs updated.	EY	Nov 30/18
	Notes and Title Block updated, sign deleted and sign added.	JM	Sep 23/08
No.	REVISIONS	BY	DATE
Approved:			
Original Signed by Allan Kwan			
Executive Director, Technical Standards Branch			
Date:	JANUARY 2005		
LONG DURATION - BRIDGE SIGNING (WORK ZONE SPEED > 60 km/h OR WORK AREA > 300mm DROP) ONE LANE CLOSURE FOUR LANE DIVIDED HIGHWAY			
Prepared By: S.L.	Checked By: J.T.	Scale: N.T.S.	Dwg No.: TCS-B-1.21B

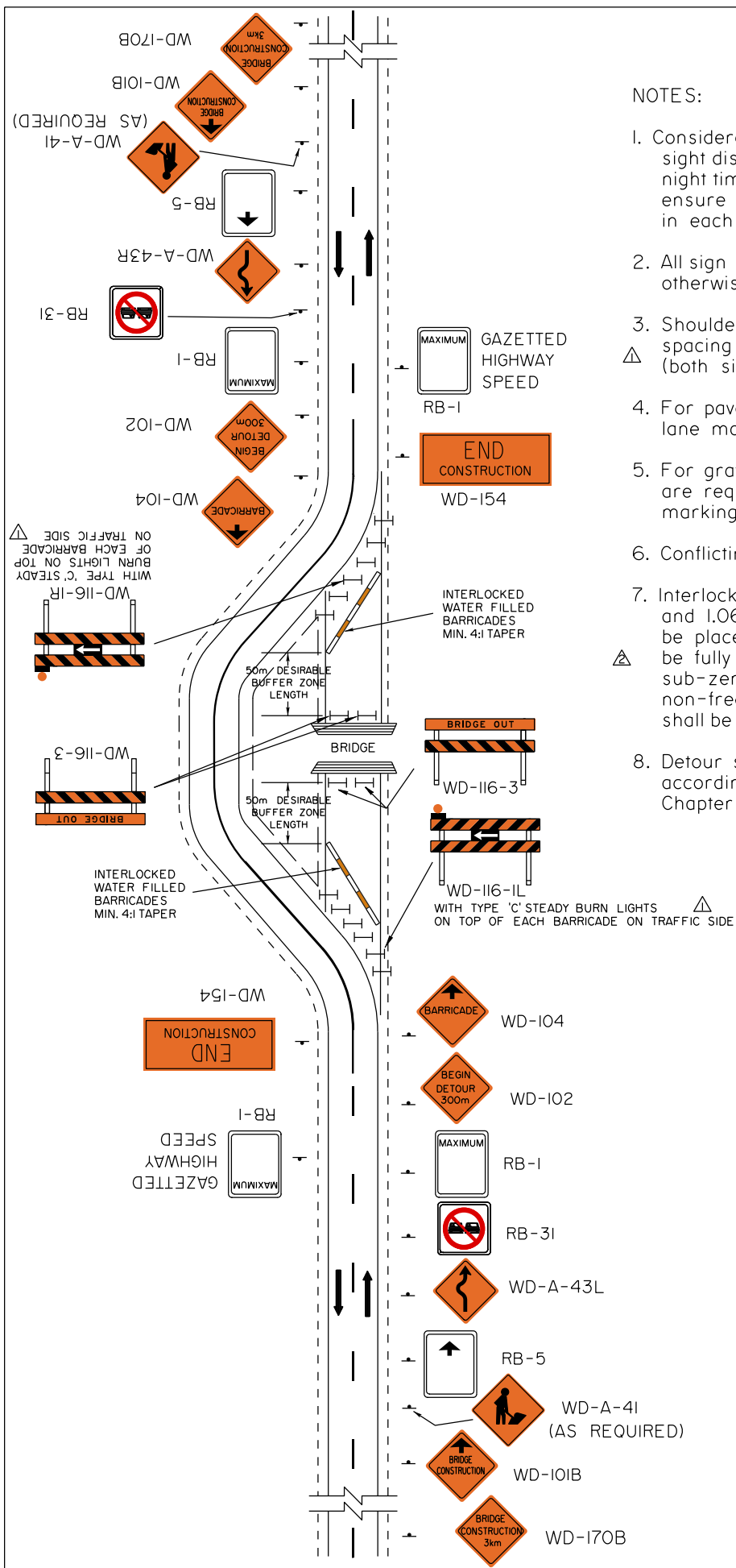

NOTES:

1. Consideration must be given to traffic volume, sight distances, sign spacing, duration of work, night time conditions and other factors to ensure traffic control devices are adequate in each instance.
2. All sign spacing shall be 100m-150m unless otherwise indicated.
3. Shoulder delineation is required on 8m spacing along the length of the detour (both sides).
4. For paved detours, line painting or temporary lane markings are required.
5. For gravel detours, temporary lane markings are required to transition painted line markings from the paved surface.
6. Conflicting lane markings shall be removed.
7. Interlocked water-filled barricades (1.83m long and 1.06m high) with minimum 4:1 taper shall be placed across the roadway. Barricades shall be fully filled at all times with water. When sub-zero temperature is conceivable, non-freezing ballast of equivalent specific gravity shall be used.
8. Detour shall be designed and illuminated according to Highway Geometric Design Guide Chapter B Temporary Highway Detours.

△			
△	Note and Title Block updated.	EY	Nov 30/18
△	Note and Title Block updated.	JM	Dec 31/07
No.	REVISIONS	BY	DATE
Approved:			
Original Signed by Allan Kwan			
Executive Director, Technical Standards Branch			
Date:	JANUARY 2005		
LONG DURATION-BRIDGE DETOUR SIGNING △ (WORK ZONE SPEED ≤ 60 km/h) AND WORK AREA < 300mm DROP △ TWO WAY TRAFFIC TWO LANE UNDIVIDED HIGHWAY			
Prepared By: S.L.	Checked By: J.T.	Scale: N.T.S.	Dwg No.: TCS-B-1.22A

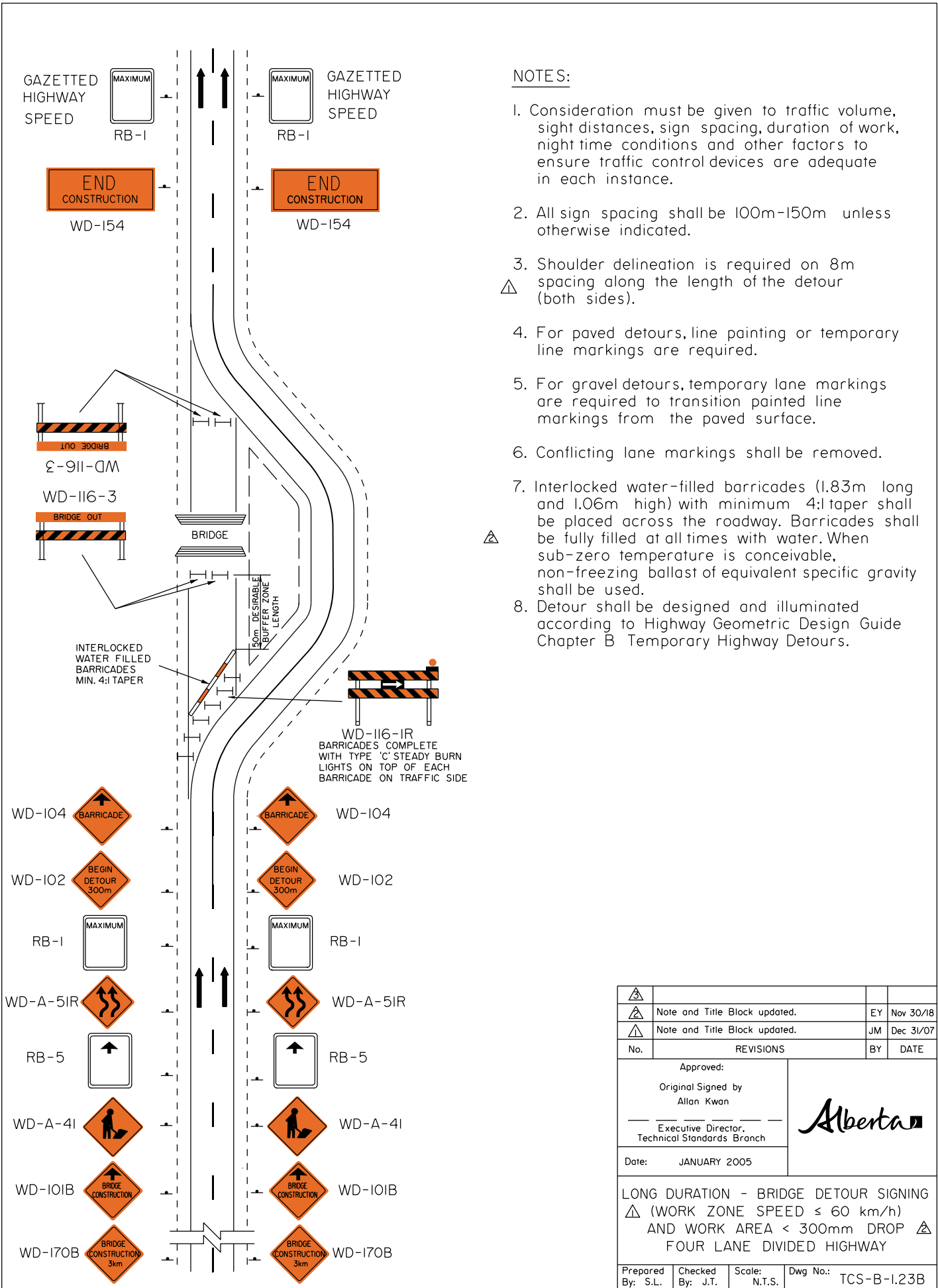

**NOTES:**

1. Consideration must be given to traffic volume, sight distances, sign spacing, duration of work, night time conditions and other factors to ensure traffic control devices are adequate in each instance.
2. All sign spacing shall be 100m-150m unless otherwise indicated.
3. Shoulder delineation is required on 8m spacing along the length of the detour (both sides).
4. For paved detours, line painting or temporary line markings are required.
5. For gravel detours, temporary lane markings are required to transition painted line markings from the paved surface.
6. Conflicting lane markings shall be removed.
7. Interlocked water-filled barricades (1.83m long and 1.06m high) with minimum 4:1 taper shall be placed across the roadway. Barricades shall be fully filled at all times with water. When sub-zero temperature is conceivable, non-freezing ballast of equivalent specific gravity shall be used.
8. Detour shall be designed and illuminated according to Highway Geometric Design Guide Chapter B Temporary Highway Detours.

△			
△	Note and Title Block updated.	EY	Nov 30/18
△	Note and Title Block updated.	JM	Dec 31/07
No.	REVISIONS	BY	DATE
Approved:			
Original Signed by Allan Kwan			
Executive Director, Technical Standards Branch			
Date:	JANUARY 2005		
LONG DURATION - BRIDGE DETOUR SIGNING △ (WORK ZONE SPEED ≤ 60 km/h) AND WORK AREA < 300mm DROP △ FOUR LANE DIVIDED HIGHWAY			
Prepared By: S.L.	Checked By: J.T.	Scale: N.T.S.	Dwg No.: TCS-B-1.23B

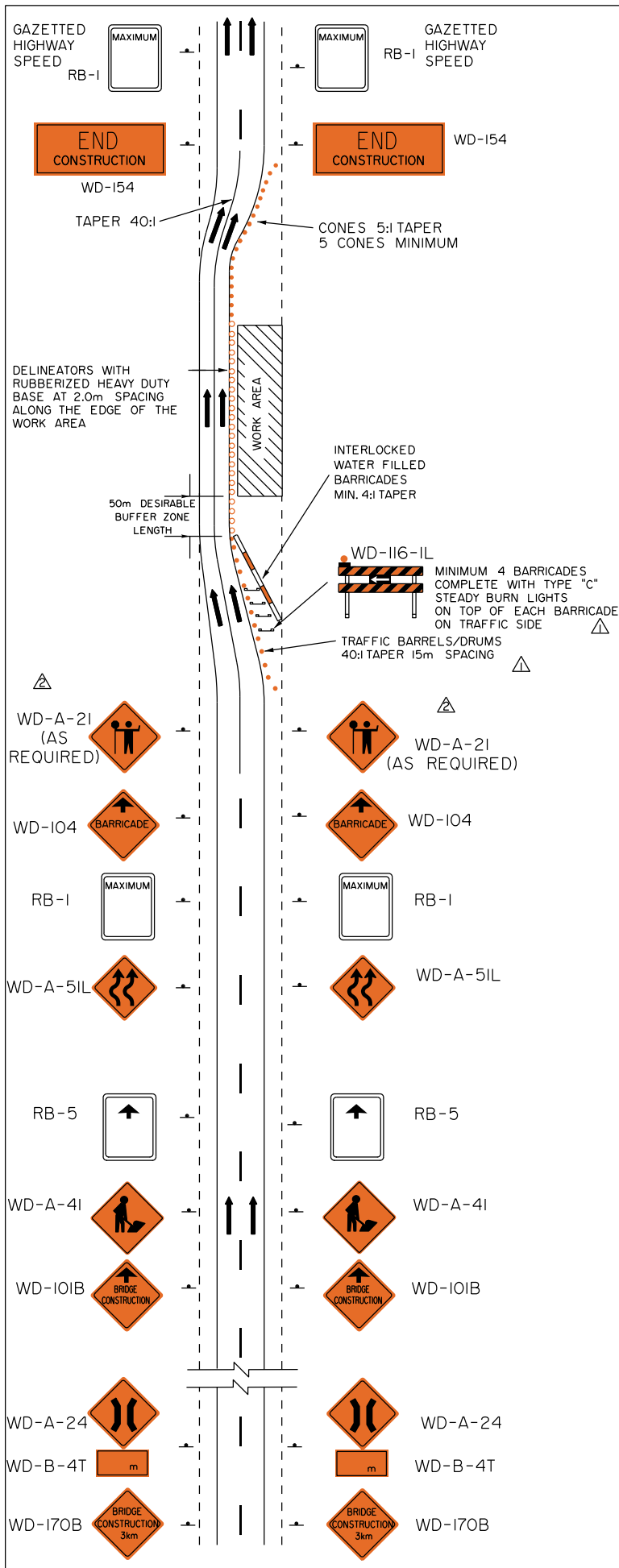

**NOTES:**

1. Consideration must be given to traffic volume, sight distances, sign spacing, duration of work, night time conditions and other factors to ensure traffic control devices are adequate in each instance.
2. When switching traffic during staged construction, a specialized traffic accommodation plan is required.
3. Interlocked water filled barricades (1.83m long and 1.03m high) with minimum 4:1 taper shall be placed across the roadway. Barricades shall be fully filled at all times with water. When sub-zero temperature is conceivable, non-freezing ballast of equivalent specific gravity shall be used.
4. All sign spacing shall be 100m-150m unless otherwise indicated.
5. A minimum lane width of 3.5m is required.
6. Temporary lane markings are required and conflicting lane markings shall be removed.

△			
△	Note and signs updated.	EY	Nov 30/18
△	Notes and Title Block updated.	JM	Dec 31/07
No.	REVISIONS	BY	DATE
Approved:			
Original Signed by Allan Kwan			
Executive Director, Technical Standards Branch			
Date:	JANUARY 2005		
LONG DURATION - BRIDGE SIGNING △ (WORK ZONE SPEED ≤ 60 km/h AND WORK AREA < 300mm DROP) FOUR LANE DIVIDED HIGHWAY			
Prepared By: S.L.	Checked By: J.T.	Scale: N.T.S.	Dwg No.: TCS-B-1.24B

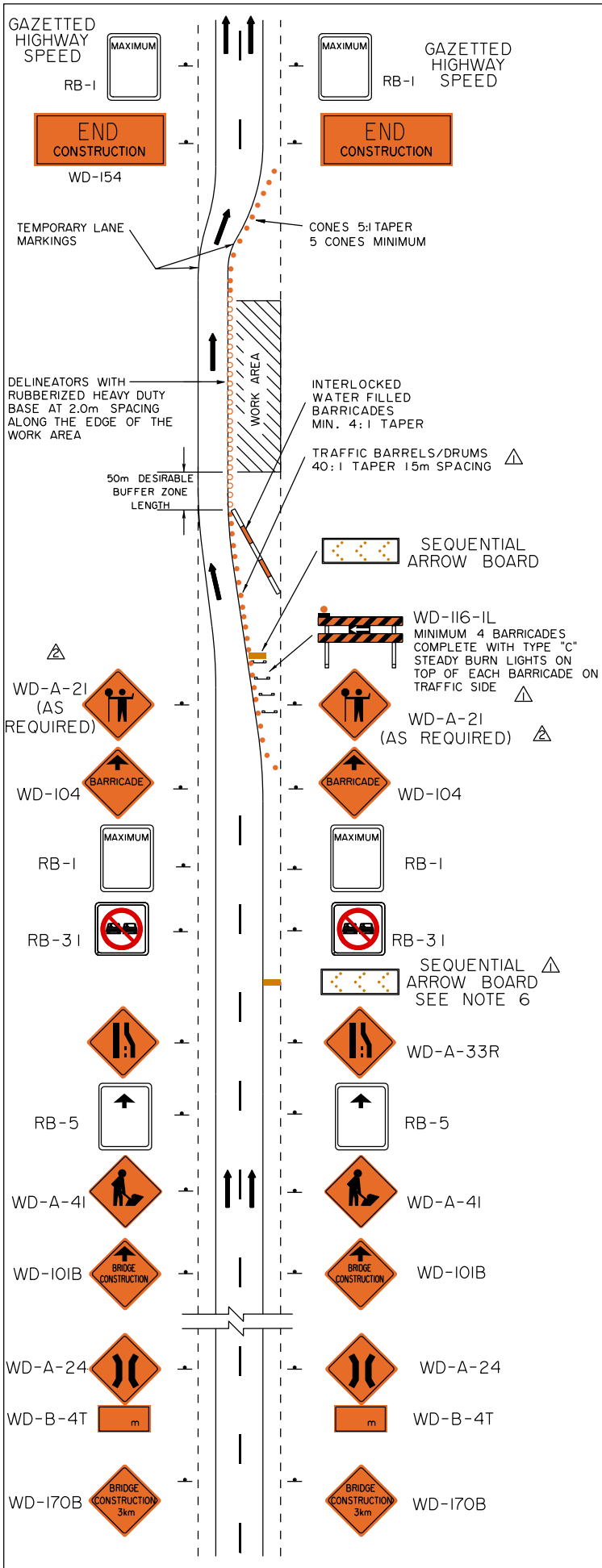

NOTES:

1. Consideration must be given to traffic volume, sight distances, sign spacing, duration of work, night time conditions and other factors to ensure traffic control devices are adequate in each instance.
2. Interlocked water-filled barricades (1.83m long and 1.06m high) with minimum 4:1 taper shall be placed across the roadway. Barricades shall be fully filled at all times with water. When sub-zero temperature is conceivable, non-freezing ballast of equivalent specific gravity shall be used.
3. All sign spacing shall be 100m-150m unless otherwise indicated
4. A minimum lane width of 3.5m is required.
5. Temporary lane markings are required and conflicting lane markings shall be removed.
6. The Sequential Arrow Board shall be located in the centre of the closed lane. An additional Sequential Arrow Board is required when traffic volumes exceed 10000 vehicles per day (ASDT) or when sight distance is restricted.

△			
△	Note and signs updated.	EY	Nov 30/18
△	Note and Title Block updated and sign added	JM	Dec 31/07
No.	REVISIONS	BY	DATE
Approved:			
Original Signed by Allan Kwan			
Executive Director, Technical Standards Branch			
Date:	JANUARY 2005		
LONG DURATION - BRIDGE SIGNING (WORK ZONE SPEED ≤ 60 km/h △ AND WORK AREA < 300mm DROP) ONE LANE CLOSURE FOUR LANE DIVIDED HIGHWAY			
Prepared By: S.L.	Checked By: J.T.	Scale: N.T.S.	Dwg No.: TCS-B-1.25B



NOTE: DETAILS OF WARNING / REGULATORY SIGNS SAME AS THOSE ON OTHER SIDE OF HIGHWAY

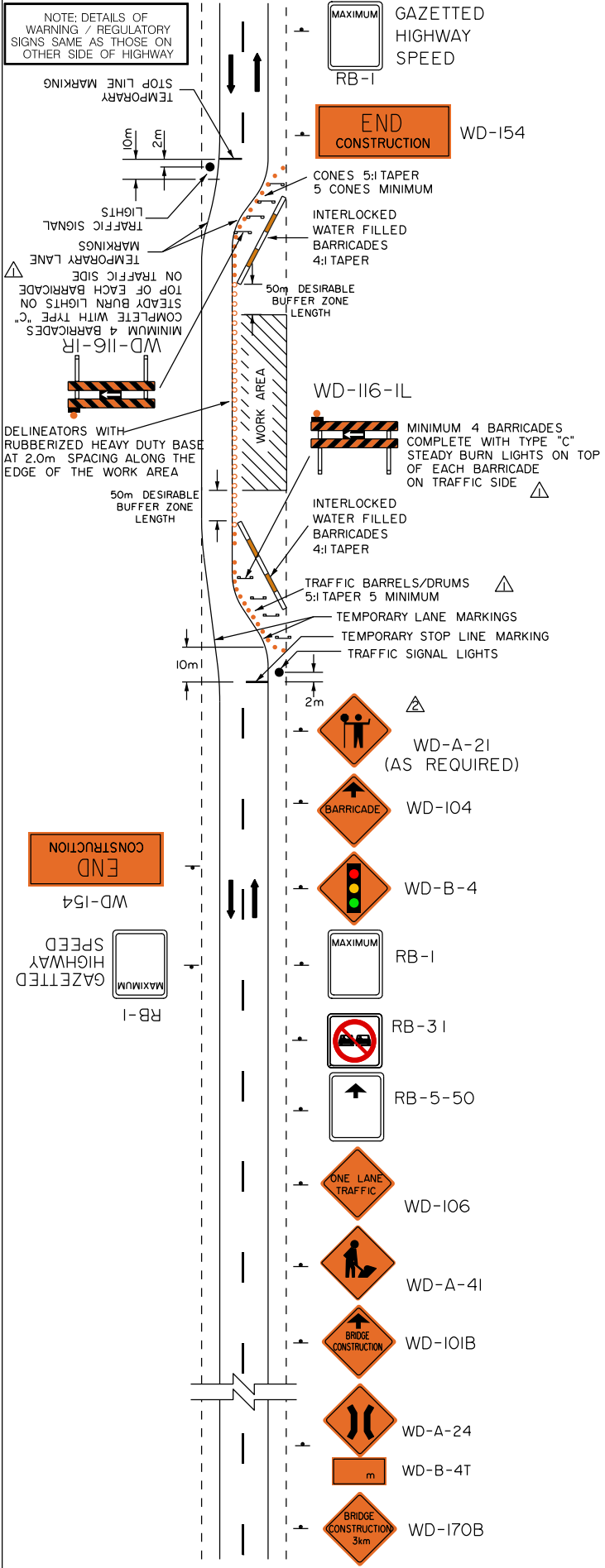

**NOTES:**

1. Consideration must be given to traffic volume, sight distances, sign spacing, duration of work, night time conditions and other factors to ensure traffic control devices are adequate in each instance.
2. Interlocked water filled barricades (1.83m long and 1.03m high) with minimum 4:1 taper shall be placed across the roadway. Barricades shall be fully filled at all times with water. When sub-zero temperature is conceivable, non-freezing ballast of equivalent specific gravity shall be used.
3. All sign spacing shall be 100m-150m unless otherwise indicated.
4. Traffic signal lights shall be 300mm diameter.
5. A minimum lane width of 3.5m is required.

△			
△	Note and sign updated.	EY	Nov 30/18
△	Notes and Title Block Updated, cones replaced by Barrels/drums	JM	Dec 31/07
No.	REVISIONS	BY	DATE
Approved:			
Original Signed by Allan Kwan			
Executive Director, Technical Standards Branch			
Date:	JANUARY 2005		
LONG DURATION - BRIDGE SIGNING △ (WORK ZONE SPEED ≤ 60 km/h AND WORK AREA < 300mm DROP) (ONE LANE ALTERNATING TRAFFIC) TWO LANE UNDIVIDED HIGHWAY			
Prepared By: S.L.	Checked By: J.T.	Scale: N.T.S.	Dwg No.: TCS-B-1.26A

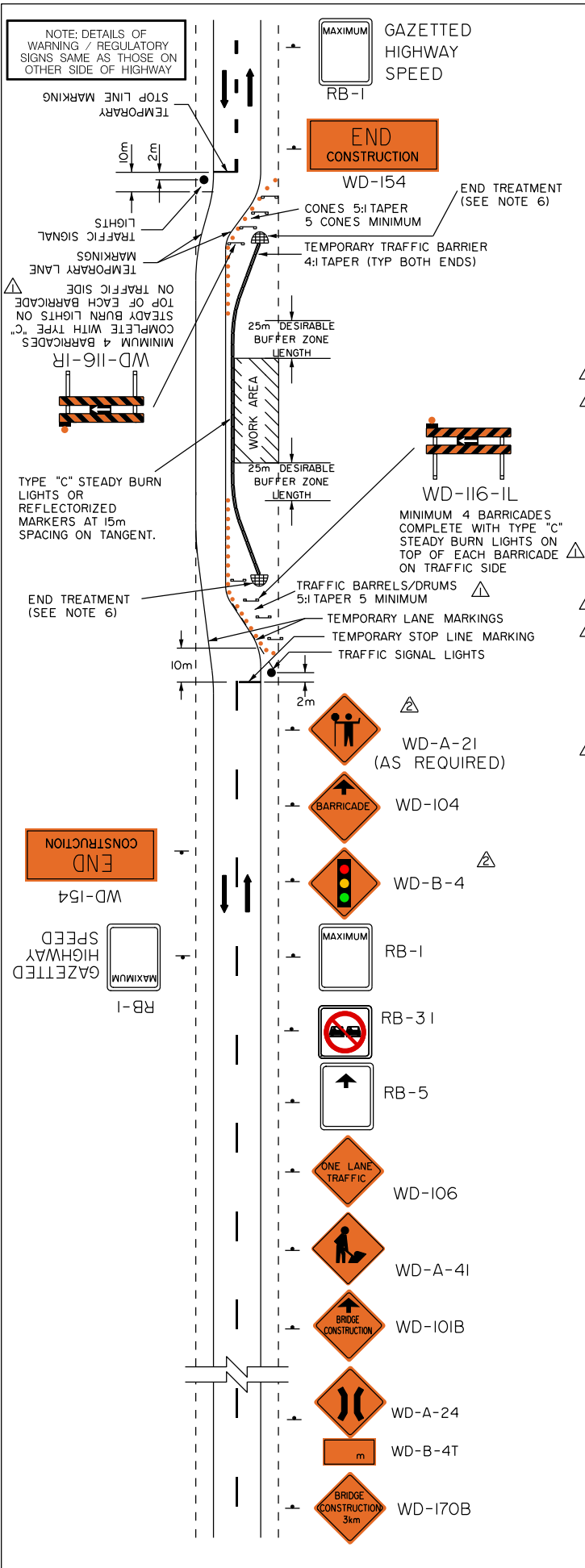

**NOTES:**

1. Consideration must be given to traffic volume, sight distances, sign spacing, duration of work, night time conditions and other factors to ensure traffic control devices are adequate in each instance.
2. All sign spacing shall be 100m-150m unless otherwise indicated
3. Traffic signal lights shall be 300mm diameter.
4. A minimum lane width of 3.5m is required.
5. Temporary traffic barriers shall be Approved Continuous Precast Concrete F-shaped Barriers (refer to Alberta Transportation's Roadside Design Guide for the latest drawing CB6-4.2MI6 or approved equivalent) meeting the requirements of NCHRP 350 Test Level 3, with proper consideration for deflection allowance behind barriers. The barriers shall be placed on pavement or properly prepared granular base.
6. The exposed ends of the barriers shall be protected by crash attenuators on Alberta Transportation's product list. If sand barrels are considered, it must be approved by the department (refer to Roadside Design Guide for the latest drawing TEB 3.19).
7. Alternatively, the barriers may be terminated outside the clear zone (refer to drawing TCS-B-1.28).

△			
△	Notes and signs updated.	EY	Nov 30/18
△	Notes and Title Block Updated, cones replaced by Barrels/drums	JM	Sep 23/08
No.	REVISIONS	BY	DATE
Approved:			
Original Signed by Allan Kwan			
Executive Director, Technical Standards Branch			
Date:	JANUARY 2005		
LONG DURATION - BRIDGE SIGNING △ (WORK ZONE SPEED ≤ 60 km/h AND WORK AREA > 300mm DROP) (ONE LANE ALTERNATING TRAFFIC) TWO LANE UNDIVIDED HIGHWAY			
Prepared By: S.L.	Checked By: J.T.	Scale: N.T.S.	Dwg No.: TCS-B-1.27A

NOTES

1. PROVIDE CRASH CUSHION IF BARRIER TERMINATES WITHIN CLEAR ZONE.
2. NO CRASH CUSHION REQUIRED IF BARRIER EXTENDED OUTSIDE CLEAR ZONE.
3. SEE SECTION 12.1.1 "APPLICATION OF THE CLEAR ZONE CONCEPT IN WORK ZONES" OF SECTION I FOR ADDITIONAL INFORMATION.

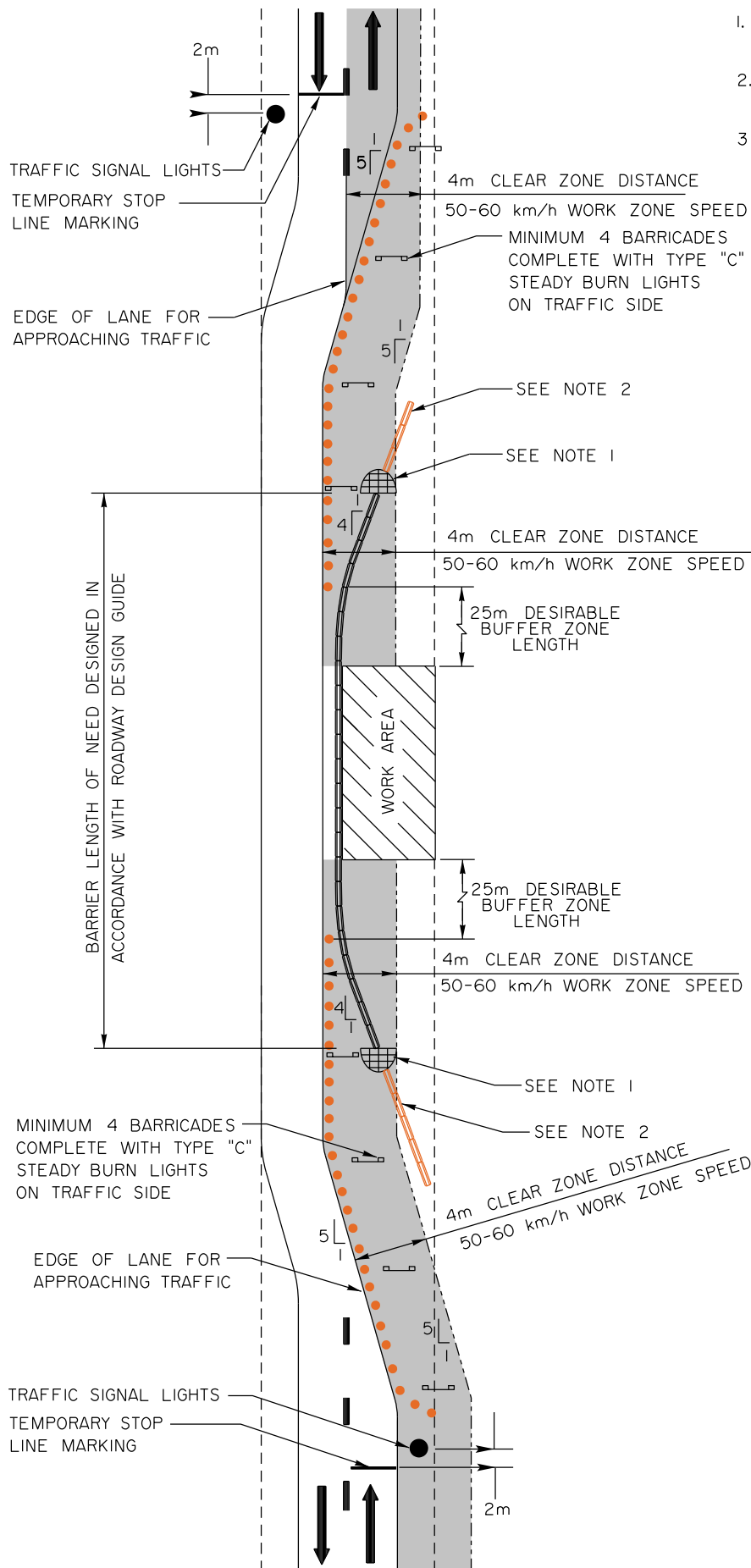

▲			
▲			
▲			
No.	REVISIONS	BY	DATE
Approved:			
Original signed by			
Allan Kwan			
Executive Director, Technical Standards Branch			
Date: OCTOBER, 2008			
EXAMPLE OF CLEAR ZONE APPLICATION FOR WORK AREA TWO LANE UNDIVIDED HIGHWAY (ONE LANE ALTERNATING TRAFFIC)			
Prepared By: G.E.C.	Checked By: J.T.	Scale: N.T.S.	Dwg No.: TCS-B-128 LONG DURATION

NOTES:

1. Consideration must be given to traffic volume, sight distances, sign spacing, duration of work and other factors to ensure traffic control devices are adequate in each instance.
2. All sign spacing shall be 100m-150m unless otherwise indicated.
3. During darkness, one Type "A" flashing light shall be placed on the traffic side of the barricade.

- △ 4. Temporary traffic barriers shall be Approved Continuous Precast Concrete F-shaped Barriers (refer to Alberta Transportation's Roadside Design Guide for the latest drawing CB6-4.2M16 or approved equivalent) meeting the requirements of NCHRP 350 Test Level 3, with proper consideration for deflection allowance behind barriers. The barriers shall be placed on pavement or properly prepared granular base.
- △ 5. The exposed ends of the barriers shall be protected by crash attenuators on Alberta Transportation's product list. If sand barrels are considered, it must be approved by the department (refer to Roadside Design Guide for the latest drawing TEB 3.19).
- △ 6. Alternatively, the barriers may be terminated outside the clear zone (refer to drawing TCS-B-1.28).

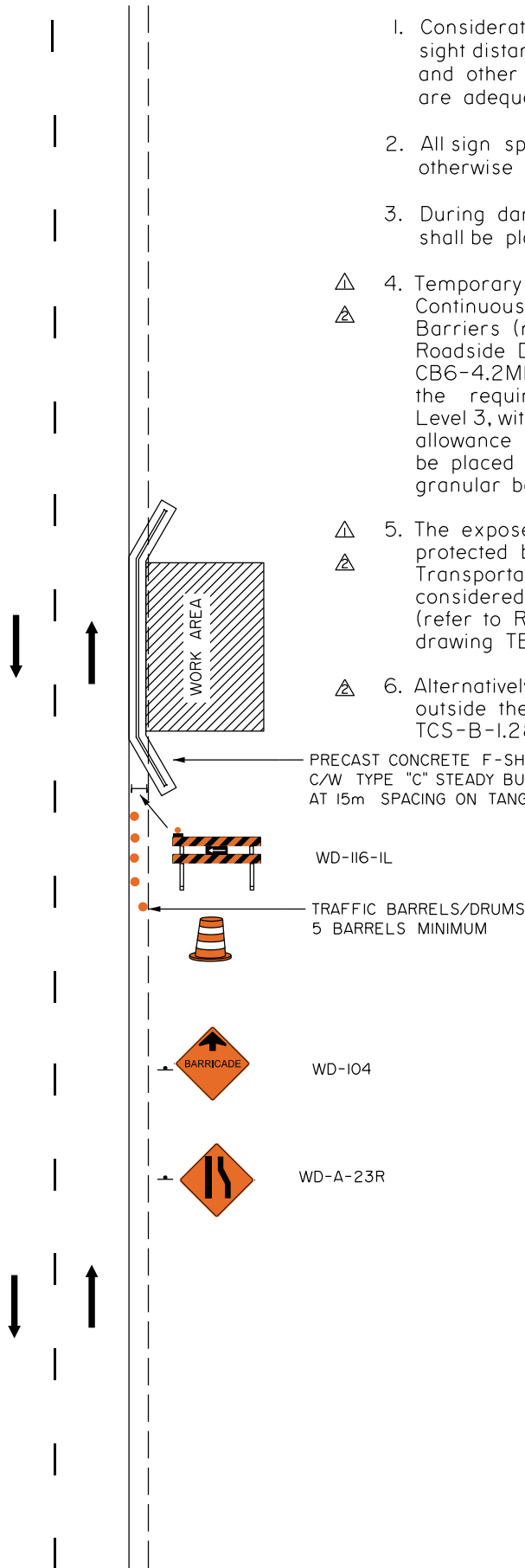

PRECAST CONCRETE F-SHAPED BARRIERS  
C/W TYPE "C" STEADY BURN LIGHTS OR REFLECTORIZED MARKERS  
AT 15m SPACING ON TANGENT

WD-II6-IL

TRAFFIC BARRELS/DRUMMS  
5 BARRELS MINIMUM

WD-104

WD-A-23R

△			
△	Notes updated.	EY	Nov 30/18
△	Notes revised.	JM	Sep 23/08
No.	REVISIONS	BY	DATE

Approved: Original Signed by Allan Kwan Executive Director, Technical Standards Branch	
Date: FEBRUARY 2003	

LONG DURATION - SIGNING LOCALIZED EXCAVATION ADJACENT TO SHOULDER (WITHIN WORK ZONE) TWO LANE UNDIVIDED HIGHWAY			
Prepared By: M.E.T.	Checked By: J.M.	Scale: N.T.S.	Dwg No.: TCS-B-1.28A

NOTES:

1. Consideration must be given to traffic volume, sight distances, sign spacing, duration of work and other factors to ensure traffic control devices are adequate in each instance.
2. All sign spacing shall be 100m-150m unless otherwise indicated.
3. During darkness, one Type "A" flashing light shall be placed on the traffic side of the barricade.
- △ 4. Temporary traffic barriers shall be Approved Continuous Precast Concrete F-shaped Barriers (refer to Alberta Transportation's Roadside Design Guide for the latest drawing CB6-4.2M16 or approved equivalent) meeting the requirements of NCHRP 350 Test Level 3, with proper consideration for deflection allowance behind barriers. The barriers shall be placed on pavement or properly prepared granular base.
- △ 5. The exposed ends of the barriers shall be protected by crash attenuators on Alberta Transportation's product list. If sand barrels are considered, it must be approved by the department (refer to Roadside Design Guide for the latest drawing TEB 3.19).
- △ 6. Alternatively, the barriers may be terminated outside the clear zone (refer to drawing TCS-B-1.29).

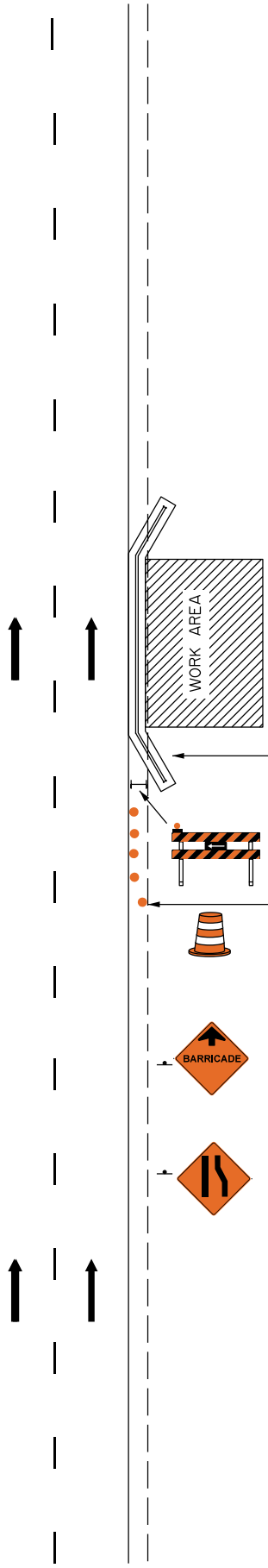

PRECAST CONCRETE F-SHAPED BARRIERS  
C/W TYPE "C" STEADY BURN LIGHTS OR REFLECTORIZED MARKERS  
AT 15m SPACING ON TANGENT

WD-II6-IL

TRAFFIC BARRELS/DRUMMS  
5 BARRELS MINIMUM

WD-104

WD-A-23R

△			
△	Notes updated.	EY	Nov 30/18
△	Notes revised.	JM	Sep 23/08
No.	REVISIONS	BY	DATE

Approved: Original Signed by Allan Kwan Executive Director, Technical Standards Branch	
Date: FEBRUARY 2003	

LONG DURATION - SIGNING LOCALIZED EXCAVATION ADJACENT TO SHOULDER (WITHIN WORK ZONE) FOUR LANE DIVIDED HIGHWAY			
Prepared By: M.E.T.	Checked By: J.M.	Scale: N.T.S.	Dwg No.: TCS-B-1.28B

NOTES

1. PROVIDE CRASH CUSHION IF BARRIER TERMINATES WITHIN CLEAR ZONE.
2. NO CRASH CUSHION REQUIRED IF BARRIER EXTENDED OUTSIDE CLEAR ZONE.
3. SEE SECTION 12.1.1 "APPLICATION OF THE CLEAR ZONE CONCEPT IN WOK ZONES" OF SECTION I FOR ADDITIONAL INFORMATION.

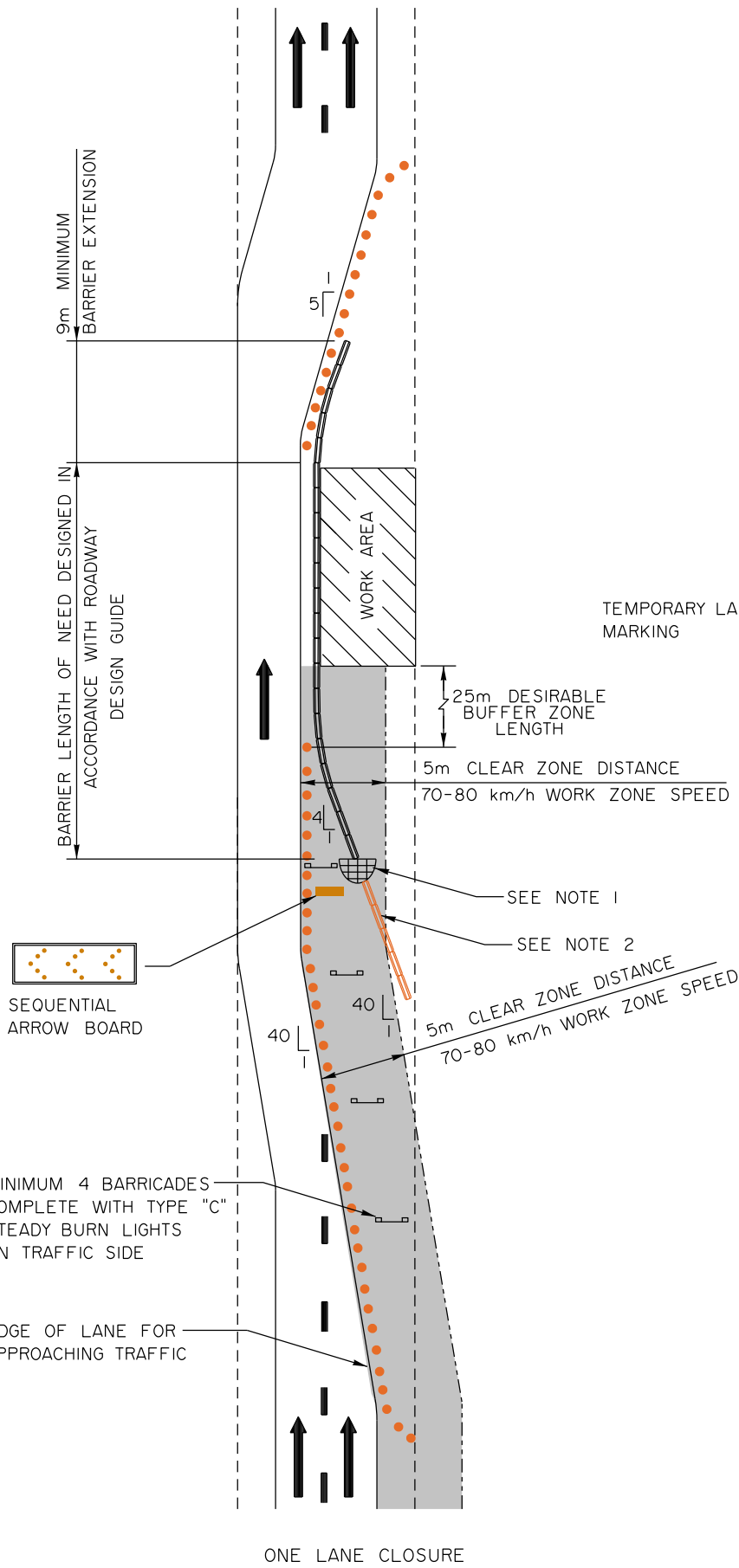

TEMPORARY LANE MARKING

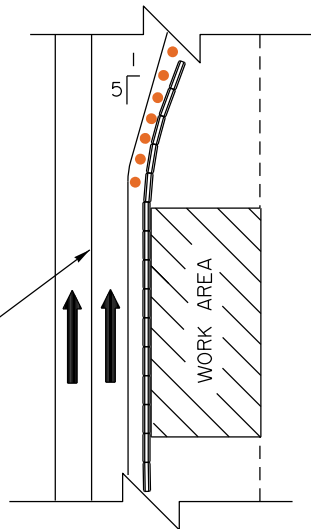

▲			
▲			
▲			
No.	REVISIONS	BY	DATE
Approved:			
Original signed by			
Allan Kwan			
Executive Director, Technical Standards Branch			
Date:	OCTOBER, 2008		
EXAMPLE OF CLEAR ZONE APPLICATION FOR WORK AREA FOUR LANE DIVIDED HIGHWAY			
Prepared By: G.E.C.	Checked By: J.T.	Scale: N.T.S.	Dwg No.: TCS-B-129 LONG DURATION

NOTES:

1. Consideration must be given to traffic volume, sight distances, sign spacing, duration of work and other factors to ensure traffic control devices are adequate in each instance.

△ 2. Signage for transition - refer to drawing  
 △ TEB 1.49 in the Typical Signage Drawings set.

• Delineators (spacing as per design requirement)

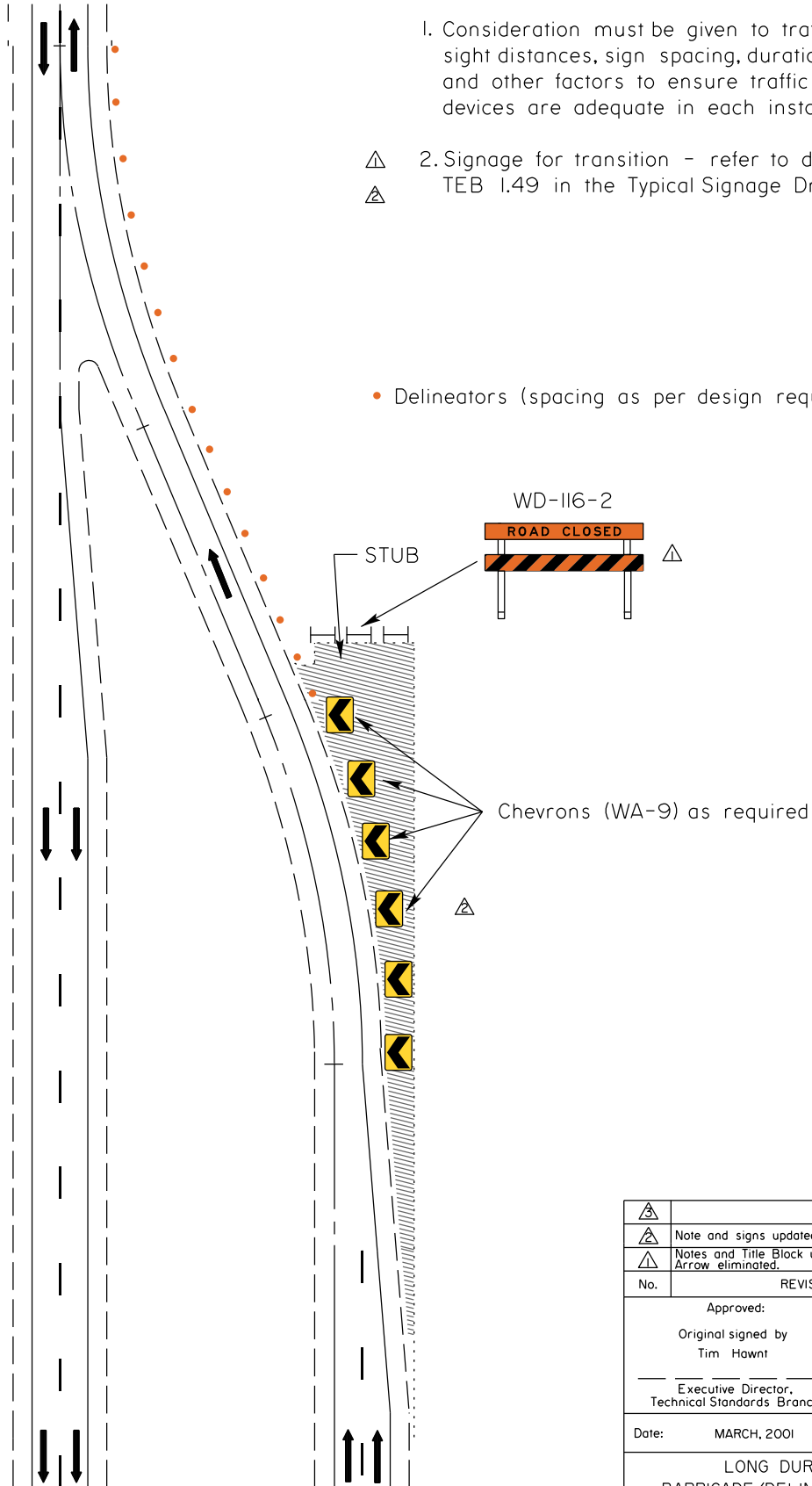

△			
△	Note and signs updated.	EY	Nov 30/18
△	Notes and Title Block updated and Arrow eliminated.	JM	Dec 31/07
No.	REVISIONS	BY	DATE

Approved:  
 Original signed by  
 Tim Hawnt  
 Executive Director,  
 Technical Standards Branch

Date: MARCH, 2001



LONG DURATION- SIGNING △  
 BARRICADE/DELINEATOR CONFIGURATION  
 HIGHWAY TRANSITION FROM FOUR LANE  
 DIVIDED TO TWO LANE UNDIVIDED  
 (WITH TEMPORARY STUB)

Prepared By: G.E.C.	Checked By: P.H.	Scale: N.T.S.	Dwg No.: TCS-B-1.29B
---------------------	------------------	---------------	----------------------

## TRAFFIC ACCOMMODATION IN WORK ZONES

### LIST OF DRAWINGS

Click the links below to get to the drawings. To go back to the Drawings by Category Table of Contents: click [here](#)

RURAL HIGHWAYS- SHORT DURATION			
TCS-B Drawing No.	2 Lane Undivided	4 or 6 Lane Divided	Description
<a href="#">2.1A</a>	X		<a href="#">One Lane Closure (One Lane Alternating Traffic)</a>
<a href="#">2.1B</a>		X	<a href="#">One Lane Closure</a>
<a href="#">2.2A</a>	X		<a href="#">Work on Shoulder</a>
<a href="#">2.2B</a>		X	<a href="#">Work on Shoulder</a>
<a href="#">2.3A</a>	X		<a href="#">Work off Road Surface</a>
<a href="#">2.3B</a>		X	<a href="#">Work off Road Surface</a>
<a href="#">2.4B</a>		X	<a href="#">Centre and Right Lane Closure Repair/Survey/Testing/Inspection Crews</a>
<a href="#">2.5B</a>		X	<a href="#">Right Lane Closure Repair/Survey/Testing/Inspection Crews</a>
<a href="#">2.6A</a>	X		<a href="#">Road Top Shaping</a>
<a href="#">2.7A</a>	X		<a href="#">Work on Centreline</a>
<a href="#">2.8B</a>		X	<a href="#">Temporary Detour Transition</a>



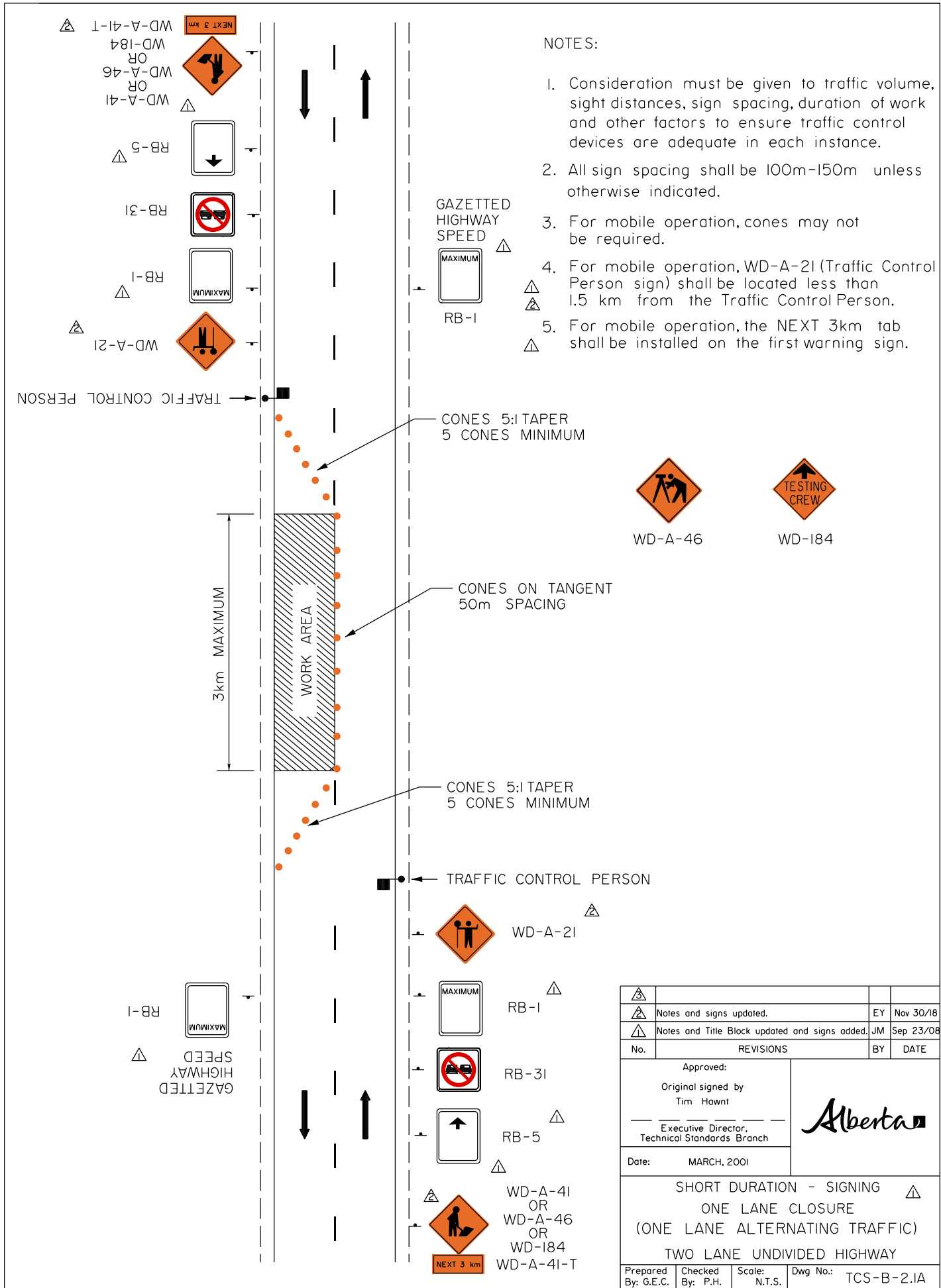

NOTES:

1. Consideration must be given to traffic volume, sight distances, sign spacing, duration of work and other factors to ensure traffic control devices are adequate in each instance.
2. All sign spacing shall be 100m-150m unless otherwise indicated.
3. For mobile operation, cones may not be required.
4. For mobile operation, WD-A-21 (Traffic Control Person sign) shall be located less than 1.5 km from the Traffic Control Person.
5. For mobile operation, the NEXT 3km tab shall be installed on the first warning sign.



WD-A-46



WD-184



WD-A-21



RB-1



RB-31



RB-5



WD-A-41  
OR  
WD-A-46  
OR  
WD-184  
WD-A-41-T

△			
△	Notes and signs updated.	EY	Nov 30/18
△	Notes and Title Block updated and signs added.	JM	Sep 23/08
No.	REVISIONS	BY	DATE
Approved:			
Original signed by Tim Hawnt			
Executive Director, Technical Standards Branch			
Date:	MARCH, 2001		
SHORT DURATION - SIGNING △ ONE LANE CLOSURE (ONE LANE ALTERNATING TRAFFIC) TWO LANE UNDIVIDED HIGHWAY			
Prepared By: G.E.C.	Checked By: P.H.	Scale: N.T.S.	Dwg No.: TCS-B-2.1A

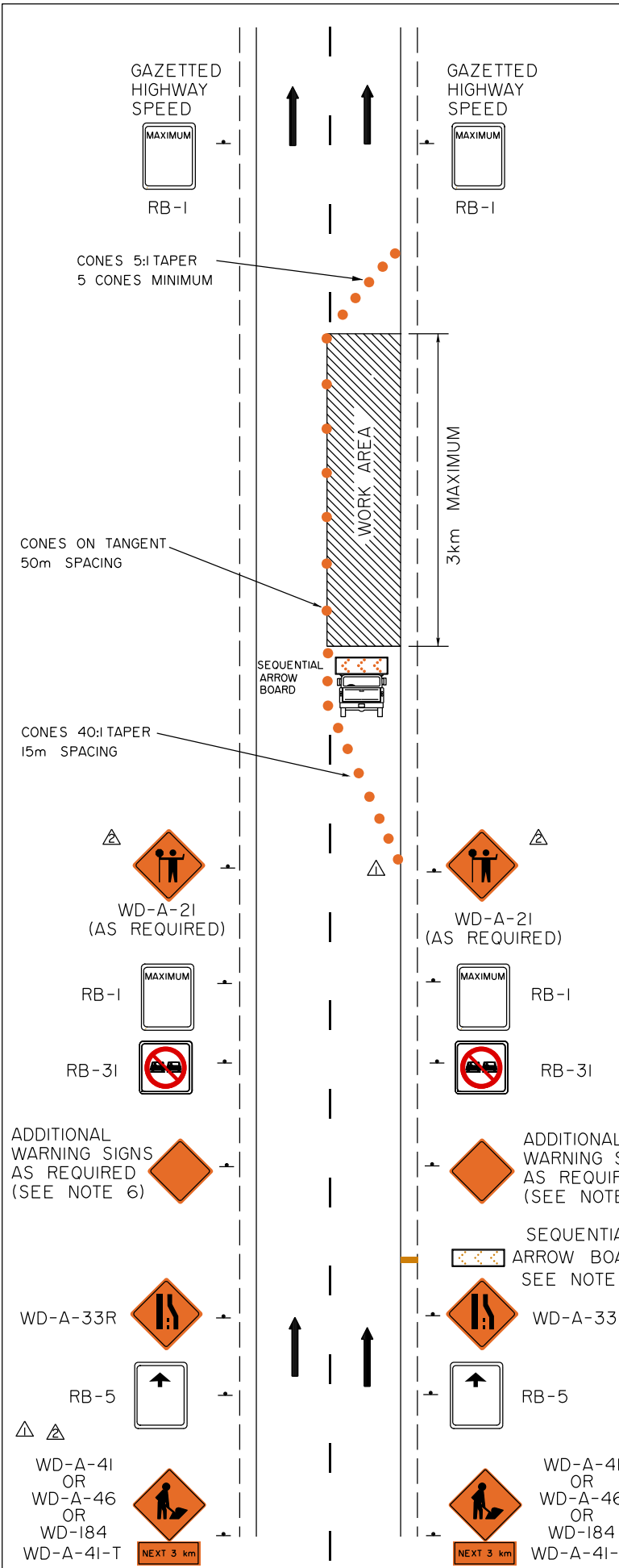

**NOTES:**

1. Consideration must be given to traffic volume, sight distances, sign spacing, duration of work and other factors to ensure traffic control devices are adequate in each instance.
2. All sign spacing shall be 100m-150m unless otherwise indicated.
3. For mobile operation, cones may not be required.
4. The Sequential Arrow Board shall be located in the centre of the closed lane. An additional Sequential Arrow Board is required when traffic volume exceeds 10000 vehicles per day (ASDT) or when sight distance is restricted. The additional Sequential Arrow Board shall be located after the lane closure sign.
5. If construction operation is occurring on the opposite travel lane, then applicable construction signing will also be required on those lanes.
6. Examples of additional warning signs that may be required are:
  - WD-A-33L
  - WD-150
  - WD-A-22
  - WD-A-III
  - WD-104
  - WD-A-49
  - WD-A-100
  - WD-157
7. Other hazard signs as shown in the schedule of signs may be used as required.
8. For mobile operation, WD-A-21 (Traffic Control Person sign) shall be located less than 1.5 km from the Traffic Control Person.
9. For mobile operation, the NEXT 3KM tab shall be installed on the first warning sign.

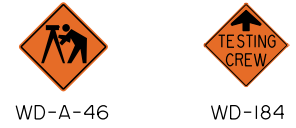
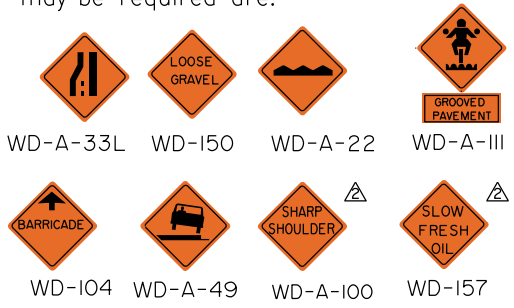

△			
△	Notes and signs updated.	EY	Nov 30/18
△	Notes and Title Block updated and signs added	JM	Sep 23/08
No.	REVISIONS	BY	DATE
Approved:			
Original signed by Tim Hawnt			
Executive Director, Technical Standards Branch			
Date:	MARCH, 2001		
SHORT DURATION - SIGNING △			
ONE LANE CLOSURE			
FOUR LANE DIVIDED HIGHWAY			
Prepared By: G.E.C.	Checked By: P.H.	Scale: N.T.S.	Dwg No.: TCS-B-2.IB

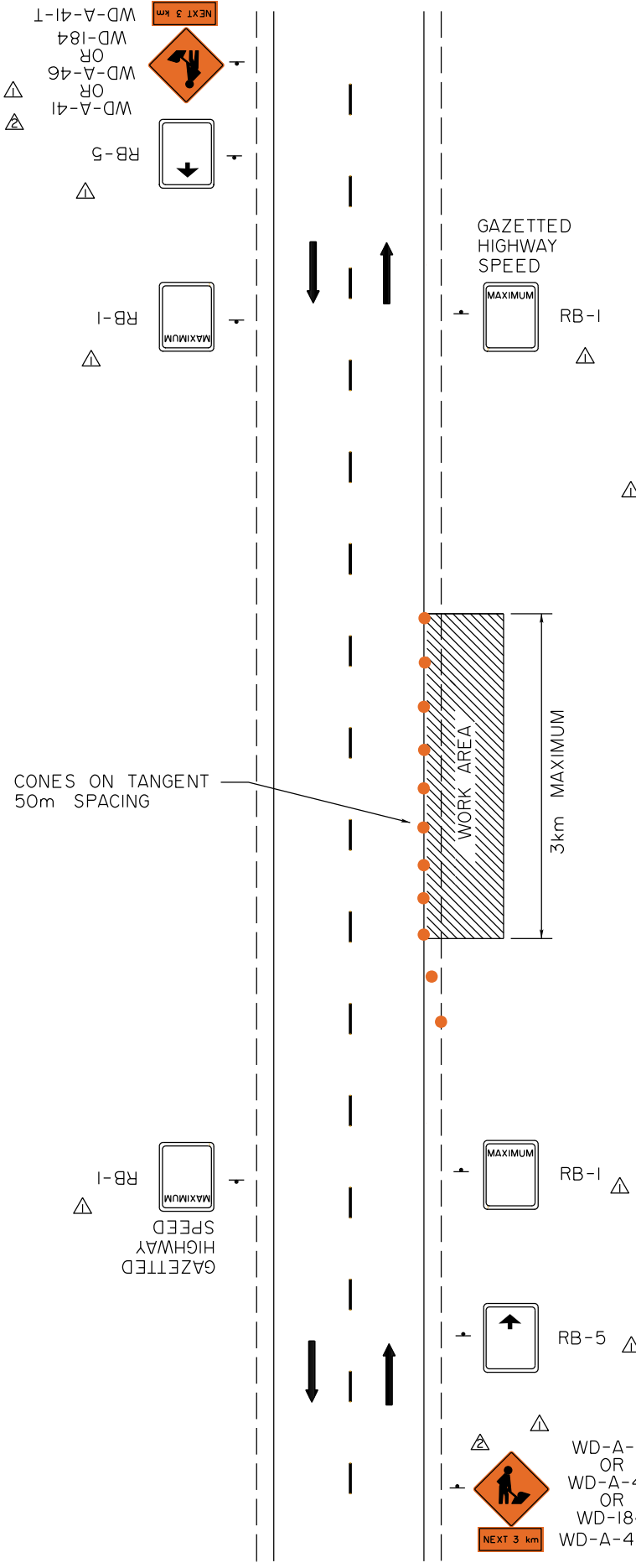

NOTES:

1. Consideration must be given to traffic volume, sight distances, sign spacing, duration of work and other factors to ensure traffic control devices are adequate in each instance.
2. All sign spacing shall be 100m-150m unless otherwise indicated.
3. For mobile operation, cones may not be required.



WD-A-46



WD-184

4. For mobile operation, the NEXT 3KM tab shall be installed on the first warning sign.

CONES ON TANGENT  
50m SPACING



△			
△	Signs updated.	EY	Nov 30/18
△	Title Block updated, note added and signs added.	JM	Dec 31/07
No.	REVISIONS	BY	DATE

Approved:  
Original signed by  
Tim Hawnt  
Executive Director,  
Technical Standards Branch

Date: MARCH, 2001



SHORT DURATION - SIGNING △  
WORK ON SHOULDER  
TWO LANE UNDIVIDED HIGHWAY

NOTES:

1. Consideration must be given to traffic volume, sight distances, sign spacing, duration of work and other factors to ensure traffic control devices are adequate in each instance.
2. All sign spacing shall be 100m-150m unless otherwise indicated.
3. For mobile operation, cones may not be required.









WD-A-46

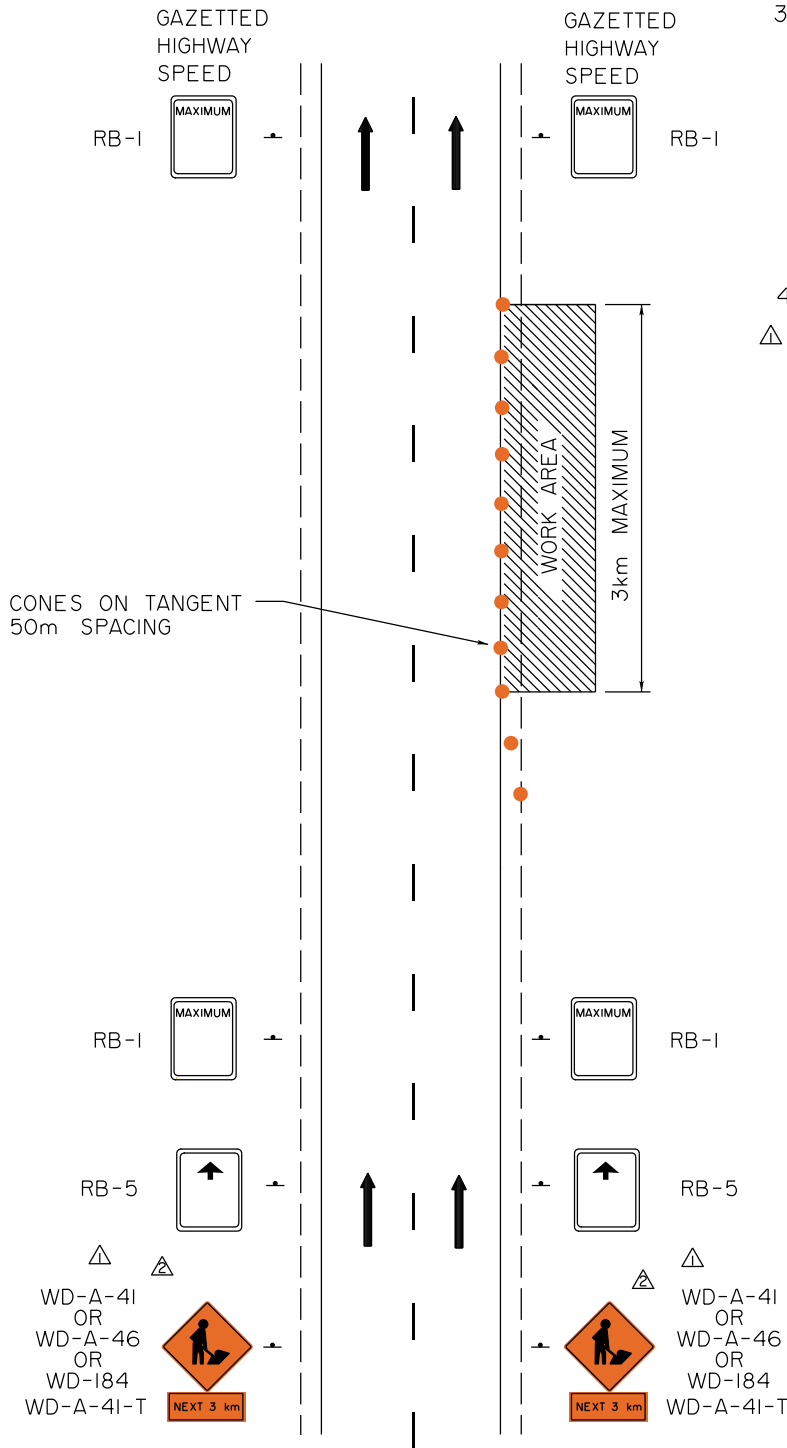

WD-184

4. For mobile operation, the NEXT 3KM tab  shall be installed on the first warning sign.



			
	Signs updated.	EY	Nov 30/18
	Title Block updated, note added and signs added.	JM	Dec 31/07
No.	REVISIONS	BY	DATE
Approved:			
Original signed by Tim Hawnt			
Executive Director, Technical Standards Branch			
Date:	MARCH, 2001		
SHORT DURATION - SIGNING  WORK ON SHOULDER FOUR LANE DIVIDED HIGHWAY			
Prepared By: G.E.C.	Checked By: P.H.	Scale: N.T.S.	Dwg No.: TCS-B-2.2B

WD-A-41  
OR  
WD-A-46  
OR  
WD-184



HIGHWAY R/W



WD-A-41  
OR  
WD-A-46  
OR  
WD-184

NOTES:

1. No vehicle shall be parked on the road surface.
2. If the work is entirely off the road surface, signs may not be required.



WD-A-46



WD-184

	Note added, and Title Block updated.	JM	Dec 31/07
No.	REVISIONS	BY	DATE
Approved:			
Original signed by Tim Hawnt			
Executive Director, Technical Standards Branch			
Date:	MARCH, 2001		
SHORT DURATION - SIGNING WORK OFF ROAD SURFACE TWO LANE UNDIVIDED HIGHWAY			
Prepared By: G.E.C.	Checked By: P.H.	Scale: N.T.S.	Dwg No.: TCS-B-2.3A

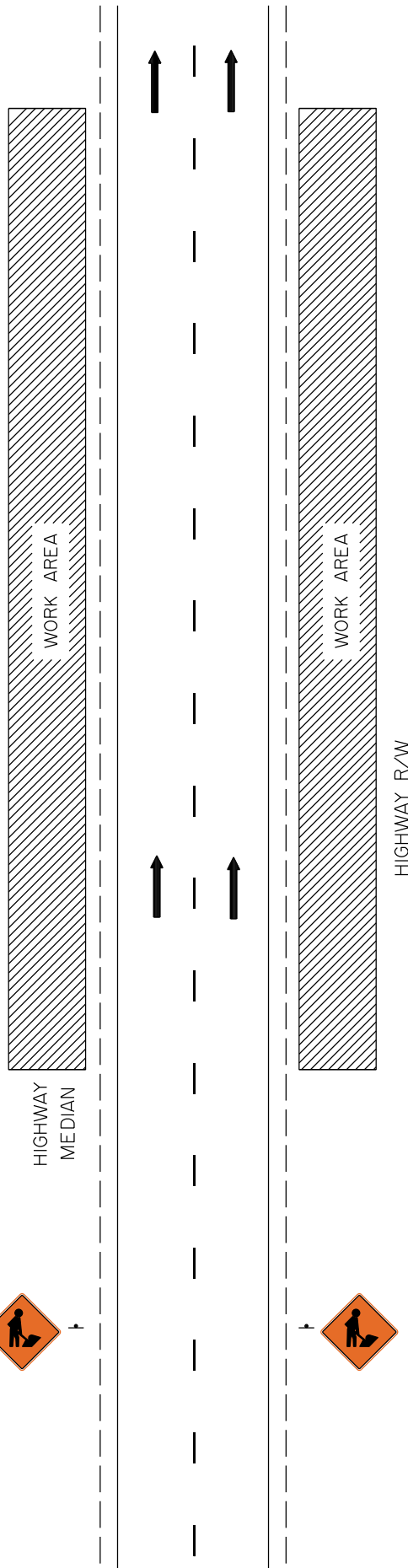

WD-A-41  
OR  
WD-A-46  
OR  
WD-184



WD-A-41  
OR  
WD-A-46  
OR  
WD-184



NOTE:

1. No vehicle shall be parked on the road surface.
2. If the work is entirely off the road surface, signs may not be required.



WD-A-46



WD-184

	Note added and Title Block updated.	JM	Dec 31/07
No.	REVISIONS	BY	DATE
Approved:			
Original signed by Tim Hawnt			
Executive Director, Technical Standards Branch			
Date:	MARCH, 2001		
SHORT DURATION - SIGNING WORK OFF ROAD SURFACE FOUR LANE DIVIDED HIGHWAY			
Prepared By: G.E.C.	Checked By: P.H.	Scale: N.T.S.	Dwg No.: TCS-B-2.3B



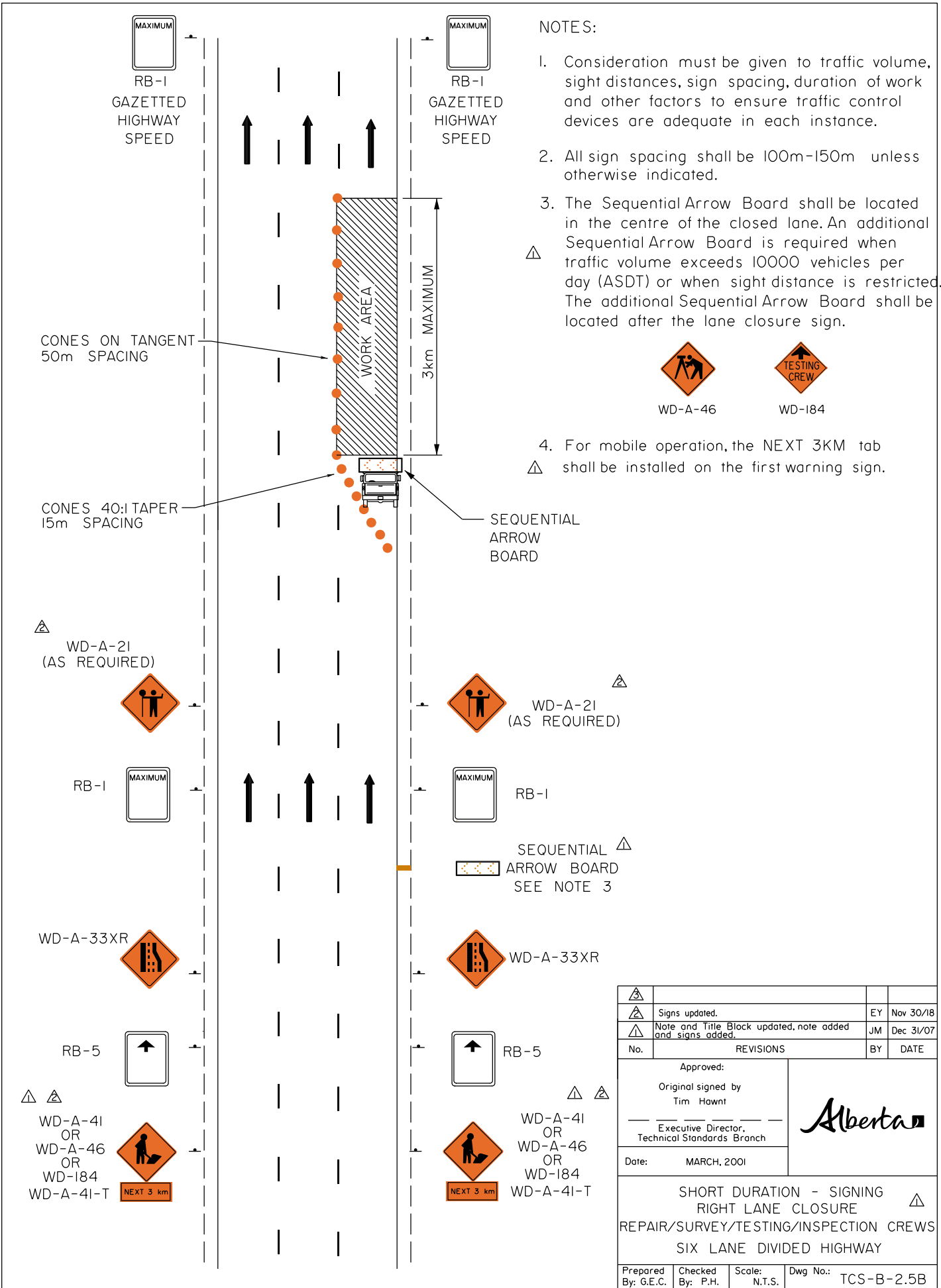

NOTES:

1. Consideration must be given to traffic volume, sight distances, sign spacing, duration of work and other factors to ensure traffic control devices are adequate in each instance.
2. All sign spacing shall be 100m-150m unless otherwise indicated.
3. The Sequential Arrow Board shall be located in the centre of the closed lane. An additional Sequential Arrow Board is required when traffic volume exceeds 10000 vehicles per day (ASDT) or when sight distance is restricted. The additional Sequential Arrow Board shall be located after the lane closure sign.

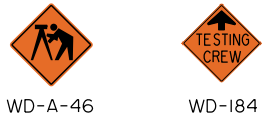

4. For mobile operation, the NEXT 3KM tab shall be installed on the first warning sign.

△			
△	Signs updated.	EY	Nov 30/18
△	Note and Title Block updated, note added and signs added.	JM	Dec 31/07
No.	REVISIONS	BY	DATE
Approved:			
Original signed by Tim Hawnt			
Executive Director, Technical Standards Branch			
Date:	MARCH, 2001		
SHORT DURATION - SIGNING RIGHT LANE CLOSURE REPAIR/SURVEY/TESTING/INSPECTION CREWS SIX LANE DIVIDED HIGHWAY			
Prepared By: G.E.C.	Checked By: P.H.	Scale: N.T.S.	Dwg No.: TCS-B-2.5B





OR

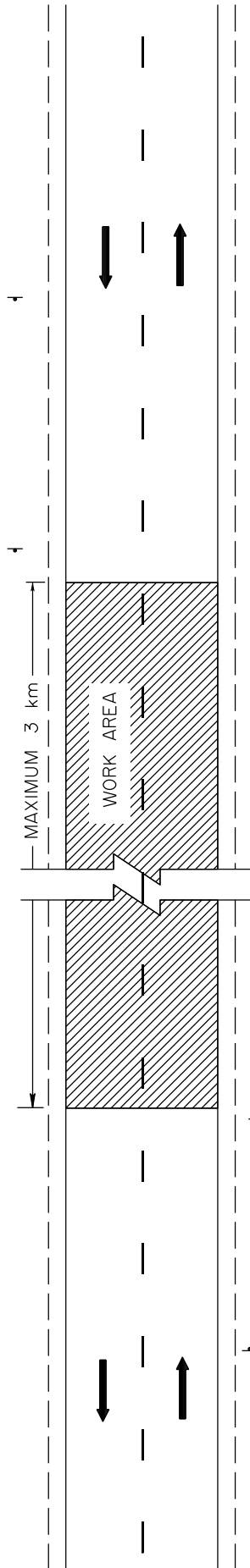
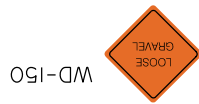

OR



NOTES:

1. Consideration must be given to traffic volume, sight distances, sign spacing, duration of work and other factors to ensure traffic control devices are adequate in each instance.
2. All sign spacing shall be 100m-150m unless otherwise indicated.

	Title Block updated.	JM	Dec 31/07
No.	REVISIONS	BY	DATE
Approved:			
Original signed by Tim Hawnt			
Executive Director, Technical Standards Branch			
Date:	MARCH, 2001		
SHORT DURATION - SIGNING ROAD TOP SHAPING TWO LANE UNDIVIDED HIGHWAY			
Prepared By: G.E.C.	Checked By: P.H.	Scale: N.T.S.	Dwg No.: TCS-B-2.6A

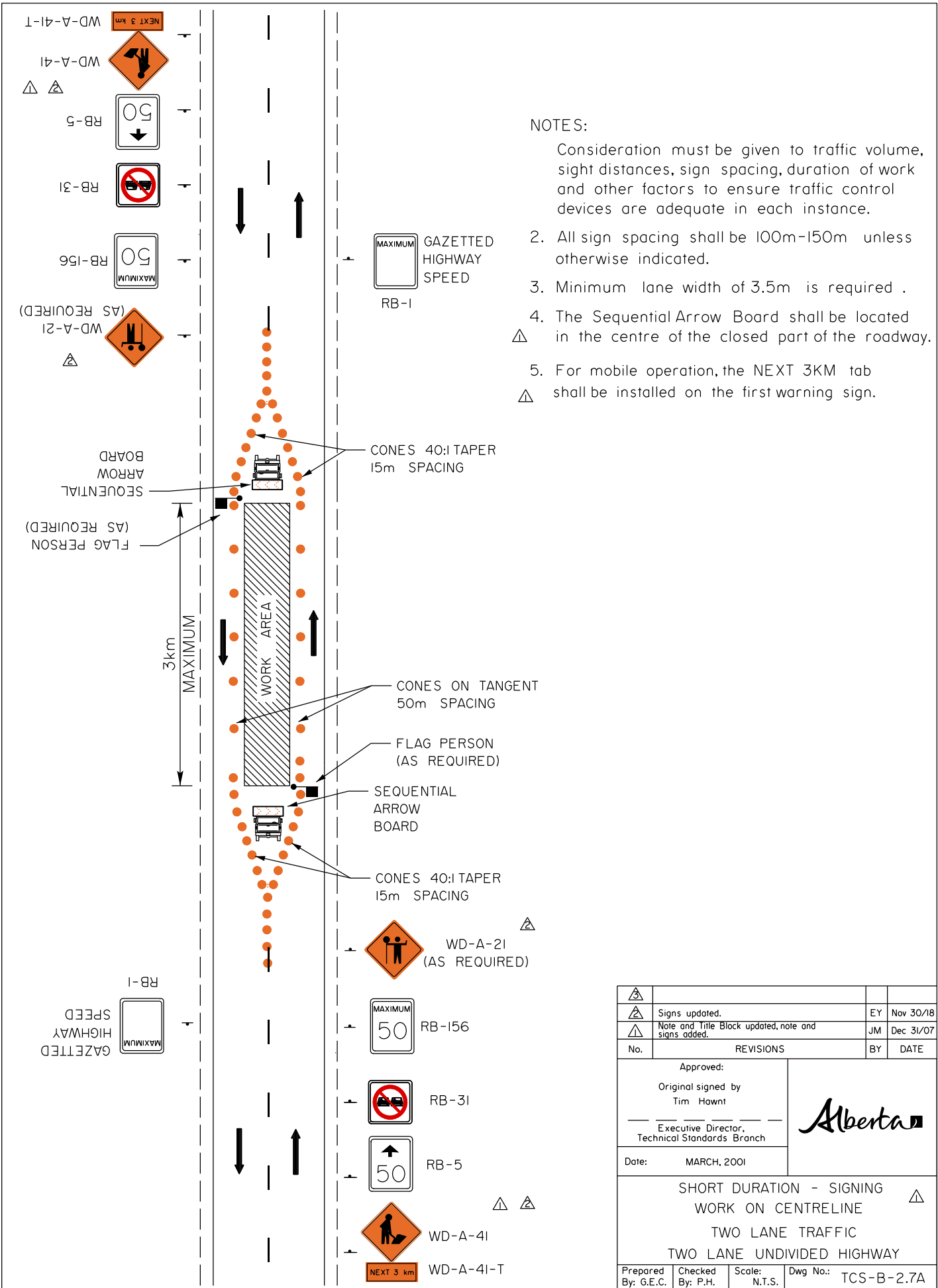

**NOTES:**

- 1. Consideration must be given to traffic volume, sight distances, sign spacing, duration of work and other factors to ensure traffic control devices are adequate in each instance.
- 2. All sign spacing shall be 100m-150m unless otherwise indicated.
- 3. Minimum lane width of 3.5m is required .
- 4. The Sequential Arrow Board shall be located in the centre of the closed part of the roadway.
- 5. For mobile operation, the NEXT 3KM tab shall be installed on the first warning sign.

△			
△	Signs updated.	EY	Nov 30/18
△	Note and Title Block updated, note and signs added.	JM	Dec 31/07
No.	REVISIONS	BY	DATE
Approved:			
Original signed by Tim Hawnt			
Executive Director, Technical Standards Branch			
Date:	MARCH, 2001		
SHORT DURATION - SIGNING WORK ON CENTRELINE TWO LANE TRAFFIC TWO LANE UNDIVIDED HIGHWAY			
Prepared By: G.E.C.	Checked By: P.H.	Scale: N.T.S.	Dwg No.: TCS-B-2.7A

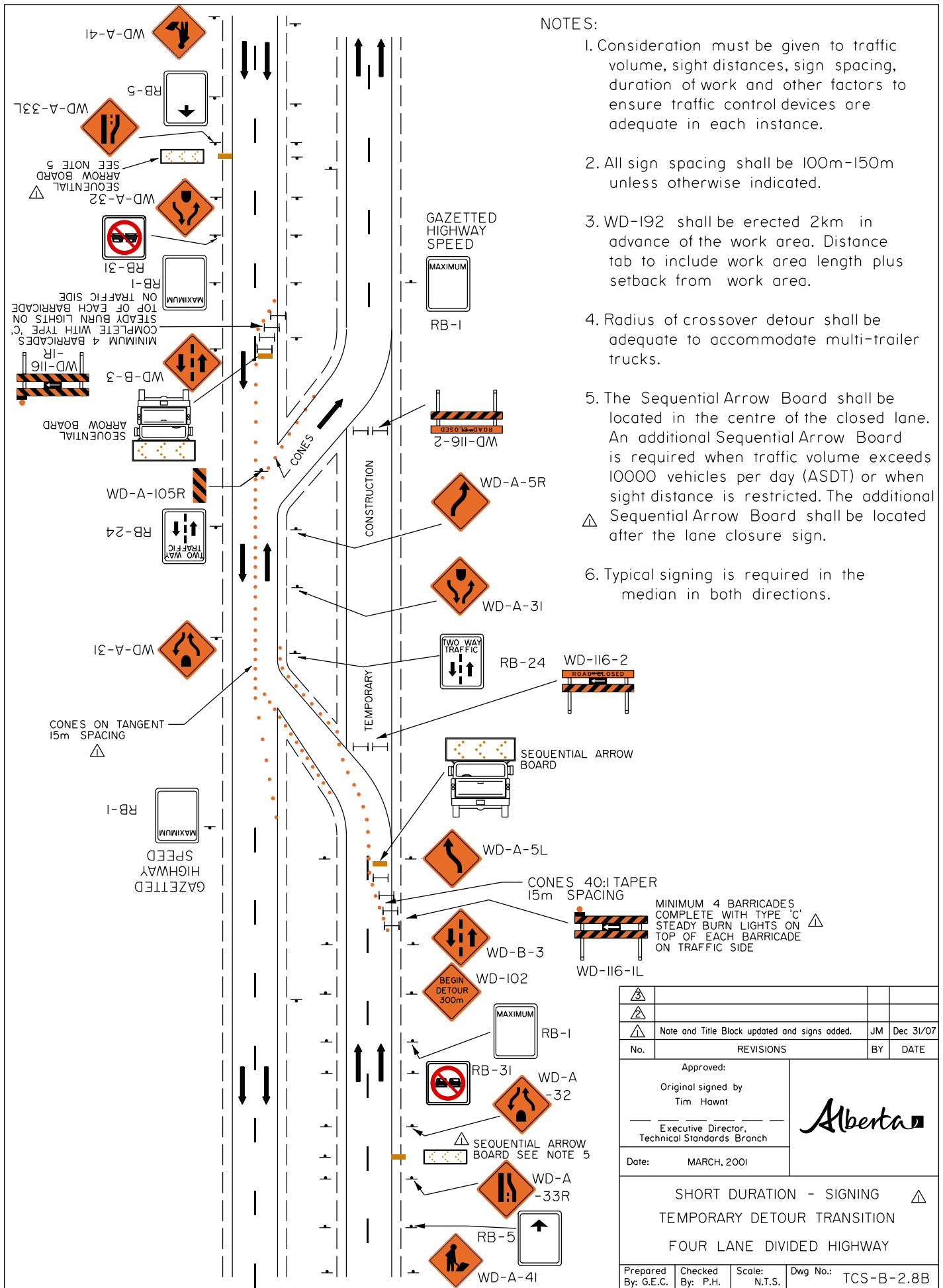

NOTES:

1. Consideration must be given to traffic volume, sight distances, sign spacing, duration of work and other factors to ensure traffic control devices are adequate in each instance.
2. All sign spacing shall be 100m-150m unless otherwise indicated.
3. WD-I92 shall be erected 2km in advance of the work area. Distance tab to include work area length plus setback from work area.
4. Radius of crossover detour shall be adequate to accommodate multi-trailer trucks.
5. The Sequential Arrow Board shall be located in the centre of the closed lane. An additional Sequential Arrow Board is required when traffic volume exceeds 10000 vehicles per day (ASDT) or when sight distance is restricted. The additional Sequential Arrow Board shall be located after the lane closure sign.
6. Typical signing is required in the median in both directions.

△			
△			
△	Note and Title Block updated and signs added.	JM	Dec 31/07
No.	REVISIONS	BY	DATE
Approved:			
Original signed by Tim Hawnt			
Executive Director, Technical Standards Branch			
Date:	MARCH, 2001		
SHORT DURATION - SIGNING △ TEMPORARY DETOUR TRANSITION FOUR LANE DIVIDED HIGHWAY			
Prepared By: G.E.C.	Checked By: P.H.	Scale: N.T.S.	Dwg No.: TCS-B-2.8B

## TRAFFIC ACCOMMODATION IN WORK ZONES

### LIST OF DRAWINGS

Click the links below to get to the drawings. To go back to the Drawings by Category Table of Contents: click [here](#)

RURAL HIGHWAYS- TESTING, SURVEYING, AND OTHER SHORT DURATION ACTIVITIES			
TCS-B Drawing No.	2 Lane Undivided	4 Lane Divided	Description
<a href="#">3.1A</a>	X		<a href="#">Traffic Survey</a>
<a href="#">3.1B</a>		X	<a href="#">Traffic Survey</a>
<a href="#">3.2A</a>	X		<a href="#">Mobile Testing</a>
<a href="#">3.2B</a>		X	<a href="#">Mobile Testing</a>
<a href="#">3.3A</a>	X		<a href="#">Gravel/Oil/Road Maintenance</a>
<a href="#">3.4A</a>	X		<a href="#">Line Painting</a>
<a href="#">3.4B</a>		X	<a href="#">Line Painting</a>
<a href="#">3.5A</a>	X		<a href="#">Chemical Vegetation Control</a>
<a href="#">3.5B</a>		X	<a href="#">Chemical Vegetation Control</a>

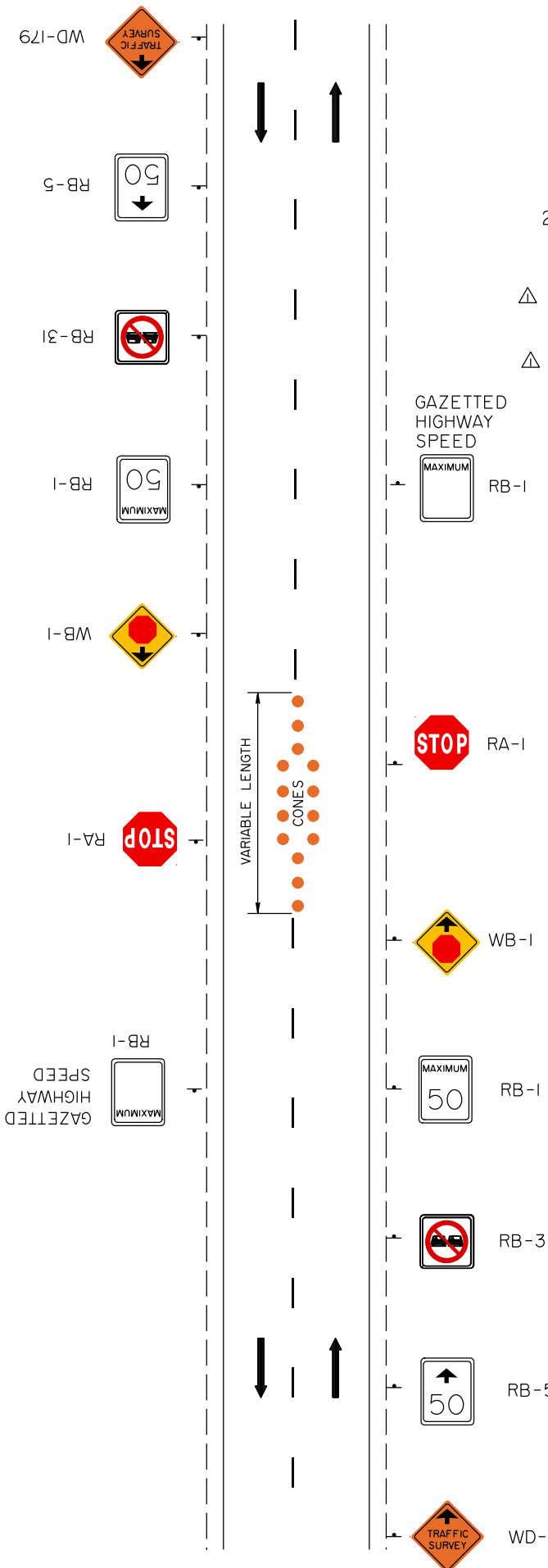

NOTES:

1. Consideration must be given to traffic volume, sight distances, sign spacing, duration of work, night time conditions and other factors to ensure traffic control devices are adequate in each instance.
2. All sign spacing shall be 100m-150m unless otherwise indicated.
- △ 3. Flagpersons may be required to slow traffic before it stops.
- △ 4. Electronic Variable Message Board is required.

*Due to the specialized nature of this type of operation, a special detailed traffic accommodation strategy must be developed for each location.*

△			
△			
△	Notes and Title Block updated.	JM	Dec 31/07
No.	REVISIONS	BY	DATE
Approved: Original signed by Tim Hawnt Executive Director, Technical Standards Branch			
Date: MARCH, 2001			
SHORT DURATION - SIGNING TRAFFIC SURVEY			△
TWO LANE UNDIVIDED HIGHWAY			
Prepared By: G.E.C.	Checked By: P.H.	Scale: N.T.S.	Dwg No.: TCS-B-3.1A

NOTES:

1. Consideration must be given to traffic volume, sight distances, sign spacing, duration of work, night time conditions and other factors to ensure traffic control devices are adequate in each instance.
2. All sign spacing shall be 100m-150m unless otherwise indicated.
3. Flagpersons may be required to slow traffic  $\Delta$  before it stops.
4. Electronic Variable Message Board is required.  $\Delta$

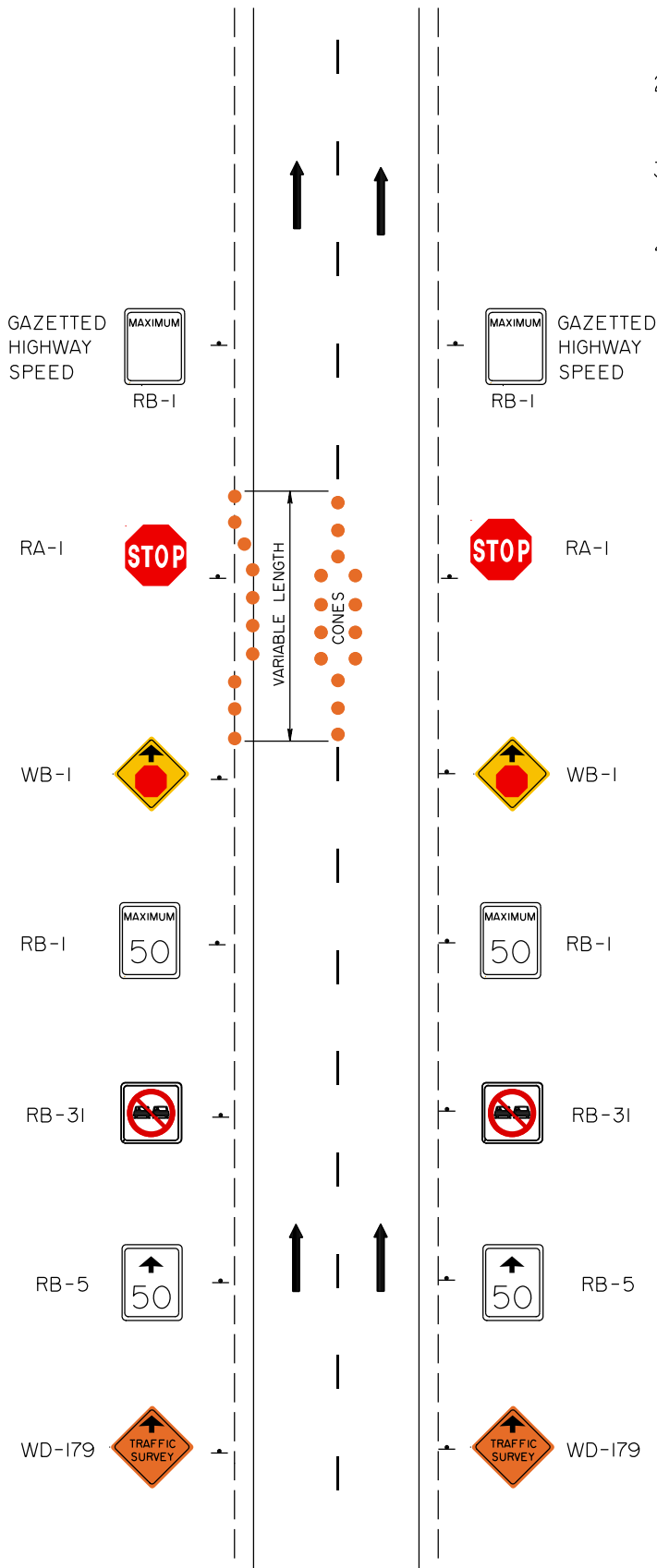

*Due to the specialized nature of this type of operation, a special detailed traffic accommodation strategy must be developed for each location.*

$\Delta$			
$\Delta$			
$\Delta$	Notes and Title Block updated.	JM	Dec 31/07
No.	REVISIONS	BY	DATE
Approved:			
Original signed by Tim Hawnt			
Executive Director, Technical Standards Branch			
Date:	MARCH, 2001		
SHORT DURATION - SIGNING $\Delta$ TRAFFIC SURVEY FOUR LANE DIVIDED HIGHWAY			
Prepared By: G.E.C.	Checked By: P.H.	Scale: N.T.S.	Dwg No.: TCS-B-3.IB

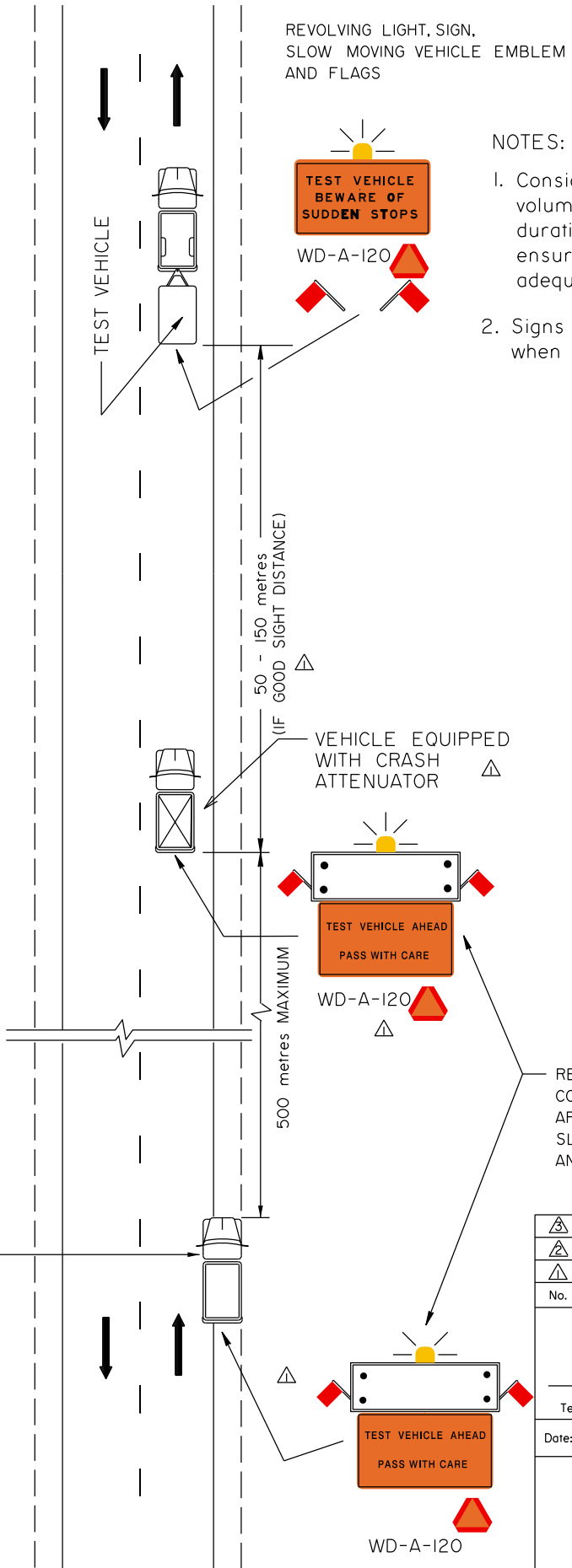

NOTES:

1. Consideration must be given to traffic volume, sight distances, sign spacing, duration of work and other factors to ensure traffic control devices are adequate in each instance.
2. Signs on trucks must be visible only when testing is in progress.

REVOLVING LIGHT,  
CORNER FLASHERS ON  
ARROW BOARD, SIGN,  
SLOW MOVING VEHICLE EMBLEM  
AND FLAGS

△			
△			
△	Notes and sign deleted, crash attenuator and pilot vehicle added and Title Block updated.	JM	Dec 31/07
No.	REVISIONS	BY	DATE
Approved:			
Original signed by Tim Hawnt			
Executive Director, Technical Standards Branch			
Date:	MARCH, 2001		
SHORT DURATION - SIGNING △ MOBILE TESTING TWO LANE UNDIVIDED HIGHWAY			
Prepared By: G.E.C.	Checked By: P.H.	Scale: N.T.S.	Dwg No.: TCS-B-3.2A

REVOLVING LIGHT, SIGN,  
SLOW MOVING VEHICLE EMBLEM  
AND FLAGS

NOTES:  $\Delta$

1. Consideration must be given to traffic volume, sight distances, sign spacing, duration of work and other factors to ensure traffic control devices are adequate in each instance.
2. Signs on trucks must be visible only when testing is in progress.
3. If ASDT is greater than 10,000 vehicles per day, a pilot truck is required.

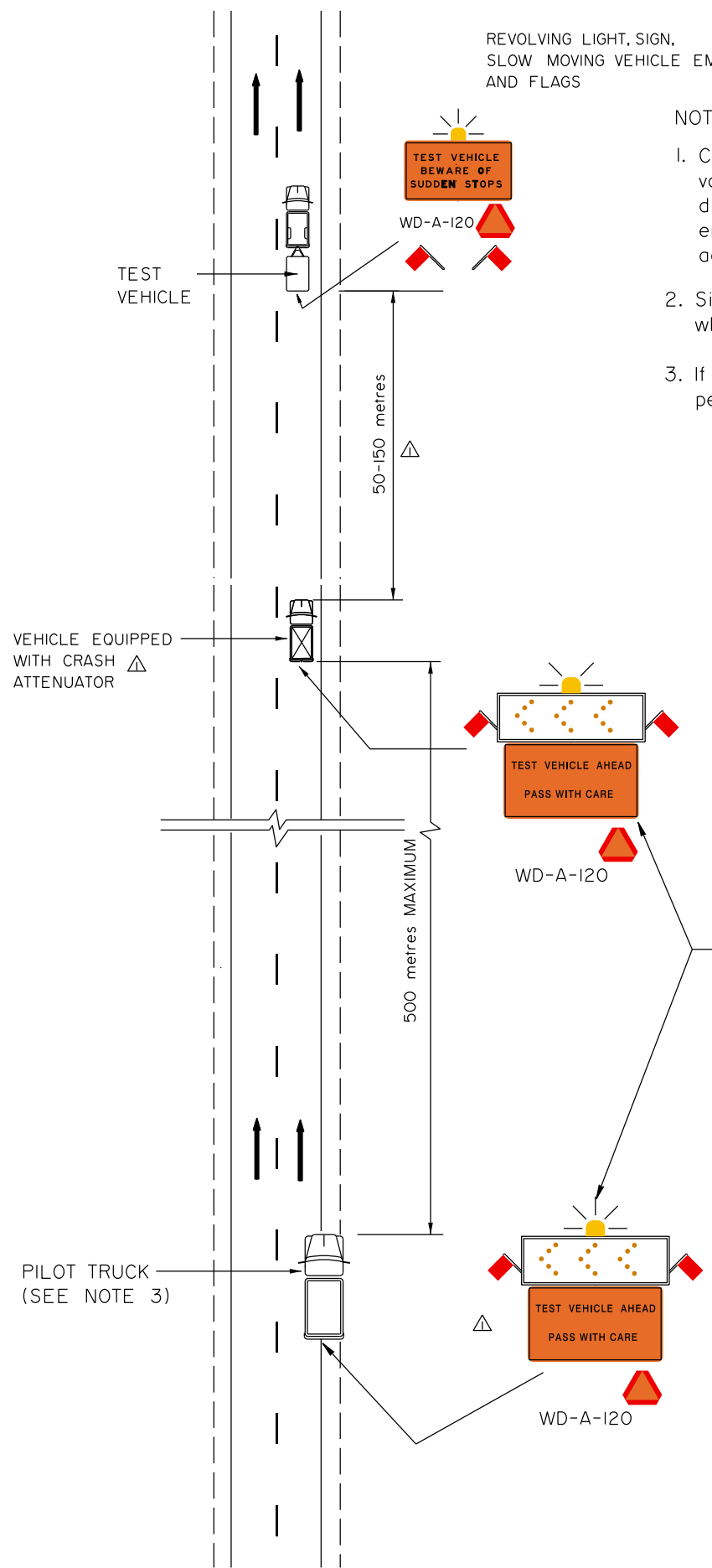

$\Delta$			
$\Delta$			
$\Delta$	Notes and sign revised, crash attenuator and pilot vehicle added and Title Block updated.	JM	Sep 23/08
No.	REVISIONS	BY	DATE
Approved:			
Original signed by Tim Hawnt			
Executive Director, Technical Standards Branch			
Date:	MARCH, 2001		
SHORT DURATION - SIGNING $\Delta$ MOBILE TESTING FOUR LANE DIVIDED HIGHWAY			
Prepared By: G.E.C.	Checked By: P.H.	Scale: N.T.S.	Dwg No.: TCS-B-3.2B



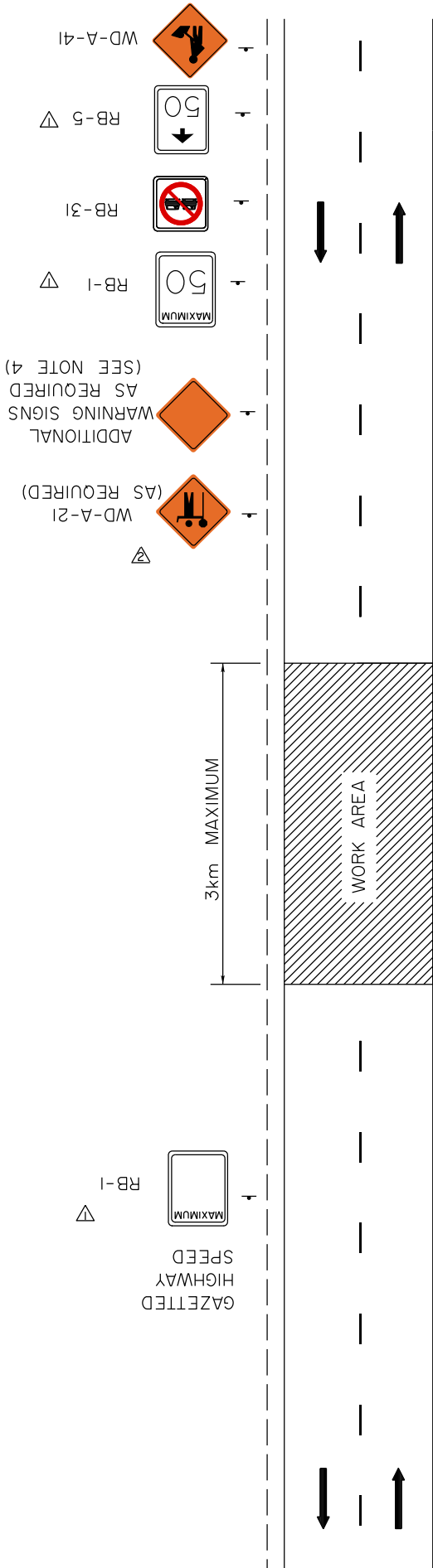

GAZETTED  
HIGHWAY  
SPEED



RB-1

NOTES:

1. Consideration must be given to traffic volume, sight distances, sign spacing, duration of work and other factors to ensure traffic control devices are adequate in each instance.
2. All sign spacing shall be 100m-150m unless otherwise indicated.
3. Speed limit and warning signs shall be placed after every intersecting roadway.
4. Examples of additional warning signs that may be required are:
  - WD-I50
  - WD-I57
  - WD-A-22
  - WD-A-100
  - WD-A-49
5. RB-1 sign shall be placed after every intersecting roadway.



WD-A-21  
(AS REQUIRED)



ADDITIONAL WARNING SIGNS AS REQUIRED  
(SEE NOTE 4)



RB-1



RB-31



RB-5



WD-A-41

	Signs updated.	EY	Oct 3/18
	Notes and Title Block updated, sign deleted, signs added.	JM	Dec 31/07
No.	REVISIONS	BY	DATE

Approved:  
Original signed by  
Tim Hawnt  
Executive Director,  
Technical Standards Branch

Date: MARCH, 2001

SHORT DURATION - SIGNING   
GRAVEL/OIL/ROAD MAINTENANCE  
TWO LANE UNDIVIDED HIGHWAY

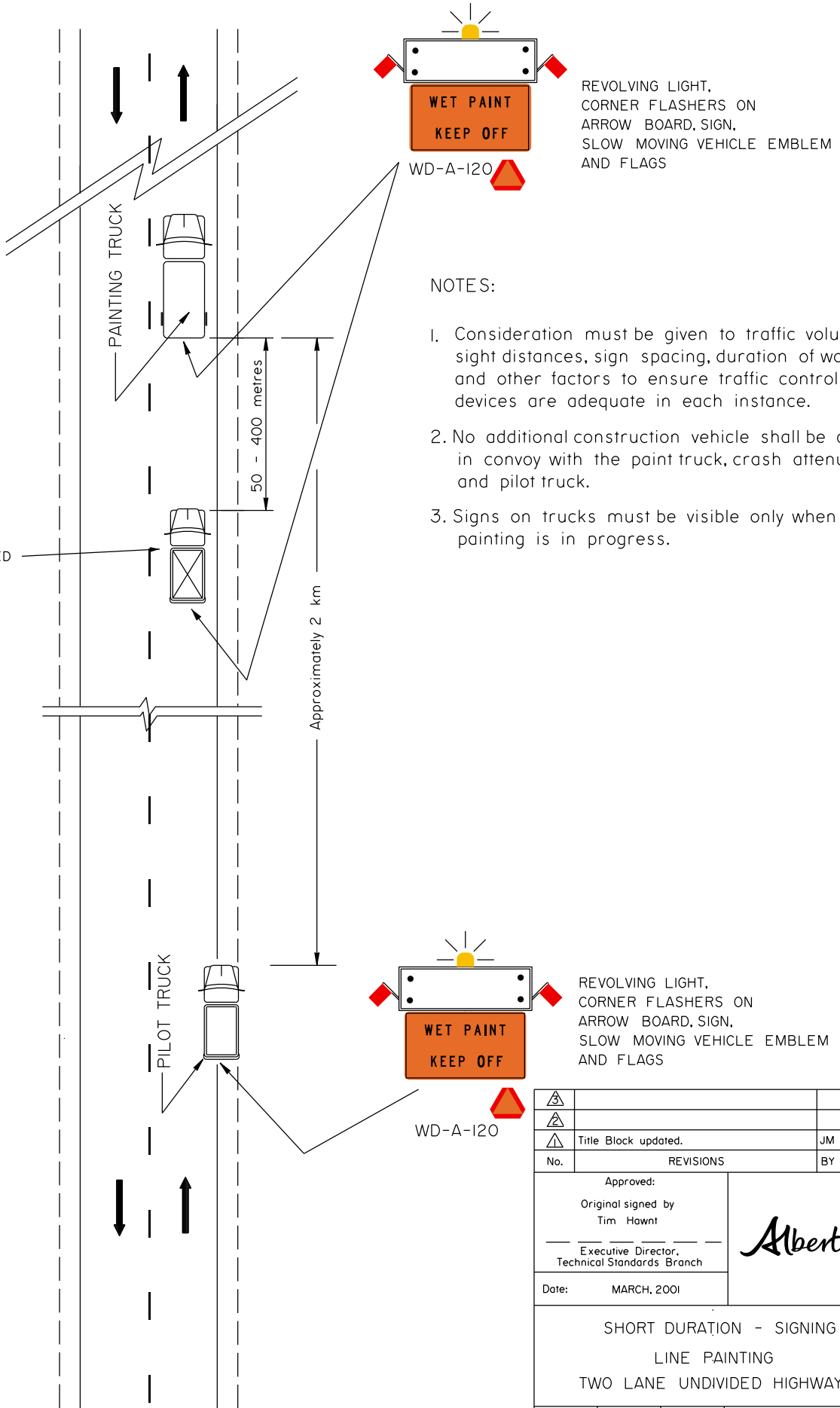

NOTES:

1. Consideration must be given to traffic volume, sight distances, sign spacing, duration of work and other factors to ensure traffic control devices are adequate in each instance.
2. No additional construction vehicle shall be driven in convoy with the paint truck, crash attenuator and pilot truck.
3. Signs on trucks must be visible only when painting is in progress.

△			
△			
△	Title Block updated.	JM	Dec 31/07
No.	REVISIONS	BY	DATE
Approved:			
Original signed by Tim Hawnt			
Executive Director, Technical Standards Branch			
Date:	MARCH, 2001		
SHORT DURATION - SIGNING △ LINE PAINTING TWO LANE UNDIVIDED HIGHWAY			
Prepared By: G.E.C.	Checked By: P.H.	Scale: N.T.S.	Dwg No.: TCS-B-3.4A

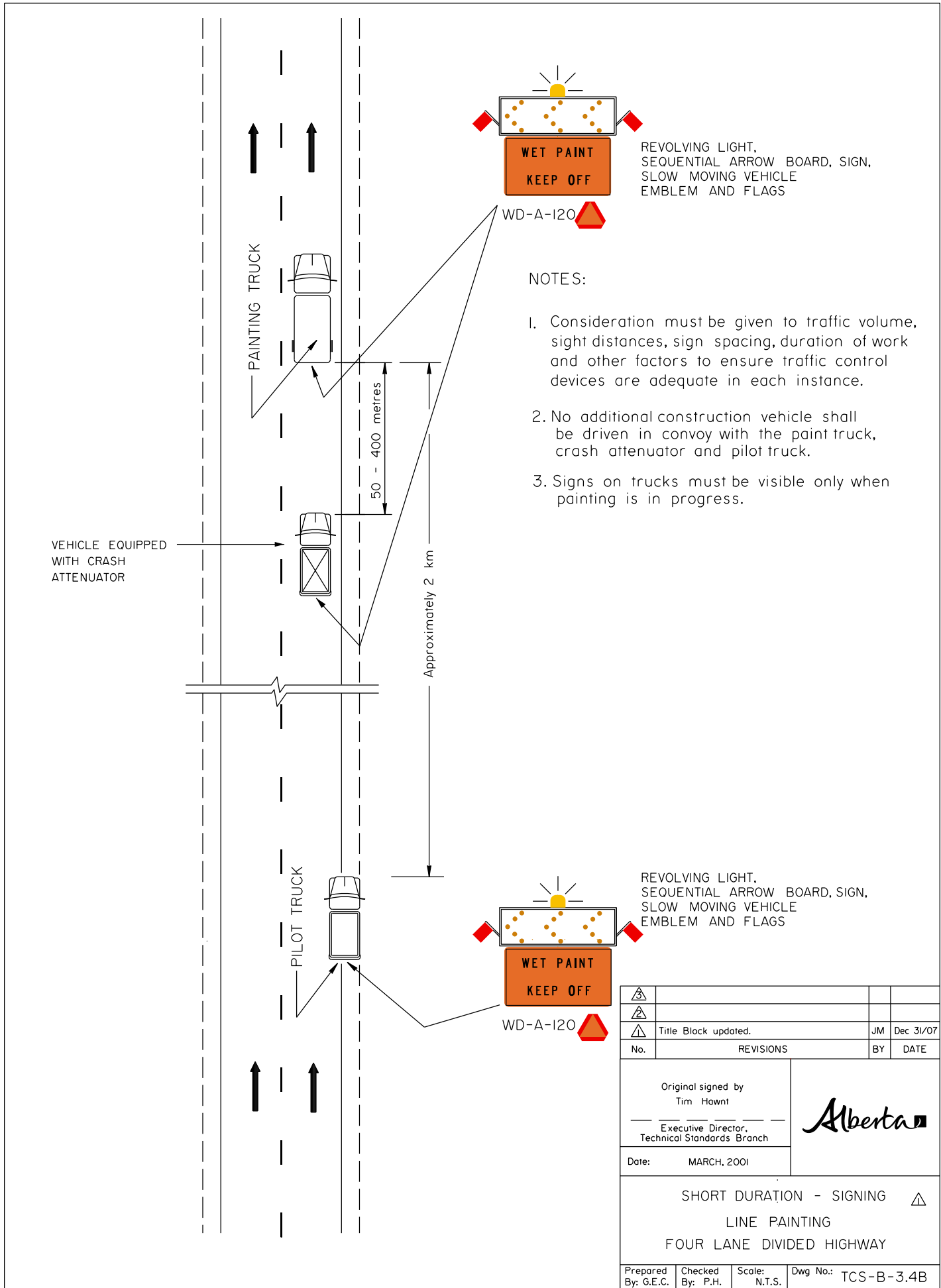

WET PAINT  
KEEP OFF

REVOLVING LIGHT,  
SEQUENTIAL ARROW BOARD, SIGN,  
SLOW MOVING VEHICLE  
EMBLEM AND FLAGS

WD-A-120

NOTES:

1. Consideration must be given to traffic volume, sight distances, sign spacing, duration of work and other factors to ensure traffic control devices are adequate in each instance.
2. No additional construction vehicle shall be driven in convoy with the paint truck, crash attenuator and pilot truck.
3. Signs on trucks must be visible only when painting is in progress.

VEHICLE EQUIPPED  
WITH CRASH  
ATTENUATOR

PAINTING TRUCK

PILOT TRUCK

50 - 400 metres

Approximately 2 km

WET PAINT  
KEEP OFF

REVOLVING LIGHT,  
SEQUENTIAL ARROW BOARD, SIGN,  
SLOW MOVING VEHICLE  
EMBLEM AND FLAGS

WD-A-120

△			
△	Title Block updated.	JM	Dec 31/07
No.	REVISIONS	BY	DATE

Original signed by  
Tim Hawnt  
Executive Director,  
Technical Standards Branch

Date: MARCH, 2001



SHORT DURATION - SIGNING △  
LINE PAINTING  
FOUR LANE DIVIDED HIGHWAY

Prepared By: G.E.C.    Checked By: P.H.    Scale: N.T.S.    Dwg No.: TCS-B-3.4B

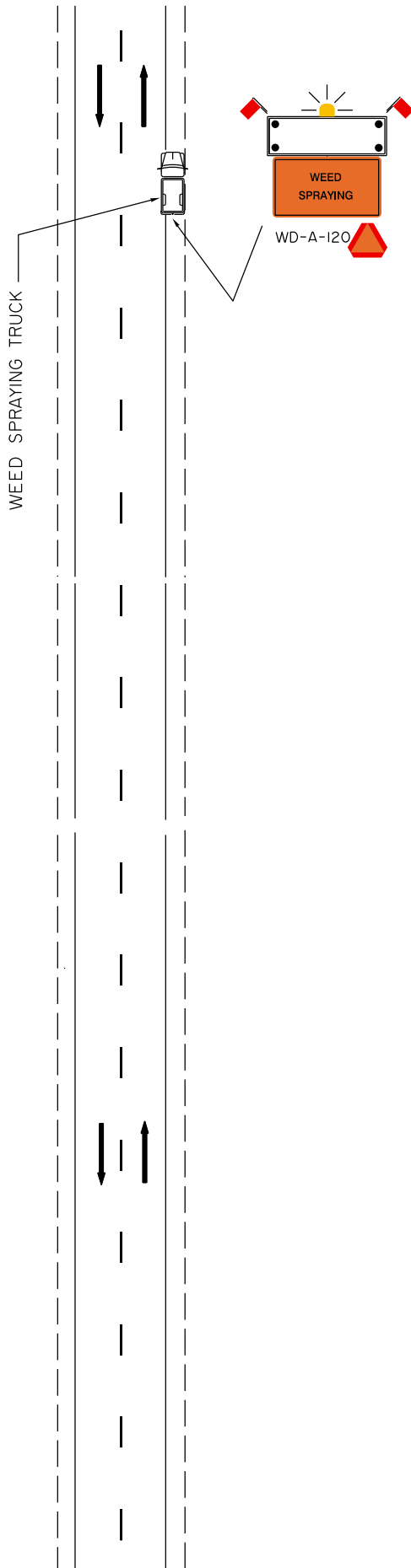

REVOLVING LIGHT,  
 CORNER FLASHERS ON  
 ARROW BOARD, SIGN,  
 SLOW MOVING VEHICLE  
 EMBLEM AND FLAGS

NOTES:

1. Consideration must be given to traffic volume, sight distances, sign spacing, duration of work and other factors to ensure traffic control devices are adequate in each instance.
2. Signs on trucks must be visible only when weed spraying is in progress.
3. A "Slow Moving Vehicle" sign shall be mounted at the rear of the vehicle and be visible to the public only when weed spraying is in progress.
4. A warning sign, mounted at the rear of the truck stating "Weed Spraying" shall have standard warning colours with letters a minimum height of 150mm and shall be visible to the public only when weed spraying is in progress.

No.	REVISIONS	BY	DATE
Approved: Original signed by Allan Kwan _____ Executive Director, Technical Standards Branch			
Date:	OCTOBER, 2008		
SHORT DURATION - SIGNING CHEMICAL VEGETATION CONTROL TWO LANE UNDIVIDED HIGHWAY			
Prepared By: G.E.C.	Checked By: J.M.	Scale: N.T.S.	Dwg No.: TCS-B-3.5A

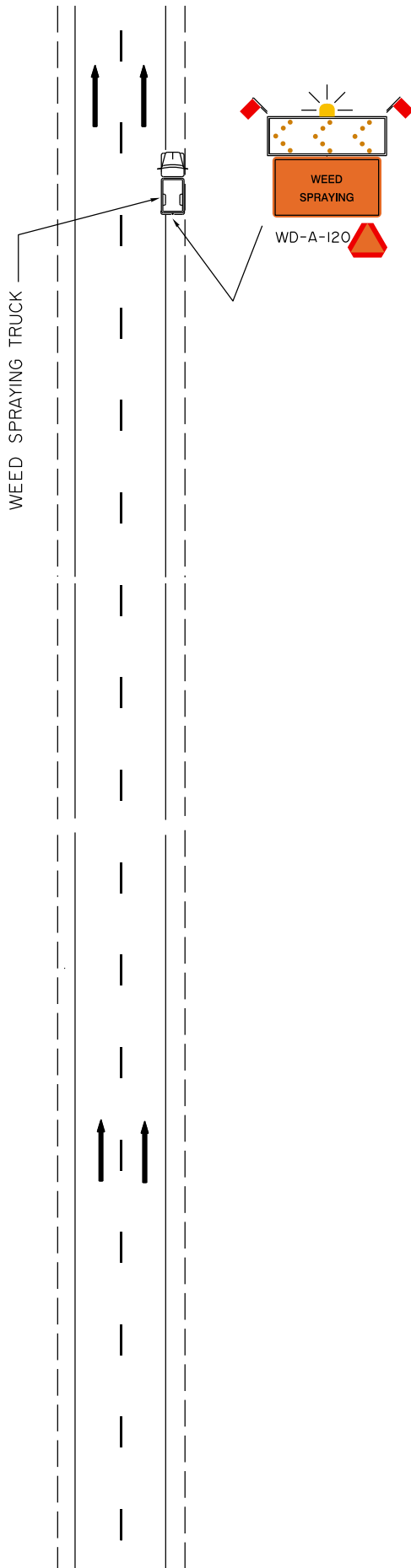

REVOLVING LIGHT,  
 SEQUENTIAL ARROW BOARD, SIGN,  
 SLOW MOVING VEHICLE  
 EMBLEM AND FLAGS

NOTES:

1. Consideration must be given to traffic volume, sight distances, sign spacing, duration of work and other factors to ensure traffic control devices are adequate in each instance.
2. Signs on trucks must be visible only when weed spraying is in progress.
3. A "Slow Moving Vehicle" sign shall be mounted at the rear of the vehicle and be visible to the public only when weed spraying is in progress.
4. A warning sign, mounted at the rear of the truck stating "Weed Spraying" shall have standard warning colours with letters a minimum height of 150mm and shall be visible to the public only when weed spraying is in progress.

No.	REVISIONS	BY	DATE
Approved: Original signed by Allan Kwan _____ Executive Director, Technical Standards Branch			
Date: OCTOBER, 2008			
SHORT DURATION - SIGNING CHEMICAL VEGETATION CONTROL FOUR LANE DIVIDED HIGHWAY			
Prepared By: G.E.C.	Checked By: P.H.	Scale: N.T.S.	Dwg No.: TCS-B-3.5B

**TRAFFIC ACCOMMODATION IN WORK ZONES****LIST OF DRAWINGS**

Click the links below to get to the drawings. To go back to the Drawings by Category Table of Contents: click [here](#)

RURAL HIGHWAYS- UTILITIES CONSTRUCTION			
TCS-B Drawing No.	2 Lane Undivided	4 Lane Divided	Description
<a href="#">5.1A</a>	X		<a href="#">Work off Road Surface</a>
<a href="#">5.1B</a>		X	<a href="#">Work off Road Surface</a>
<a href="#">5.2A</a>	X		<a href="#">Work on Shoulder</a>
<a href="#">5.2B</a>		X	<a href="#">Work on Shoulder</a>
<a href="#">5.3A</a>	X		<a href="#">One Lane Closure ( One Lane Alternating Traffic)</a>
<a href="#">5.3B</a>		X	<a href="#">One Lane Closure</a>

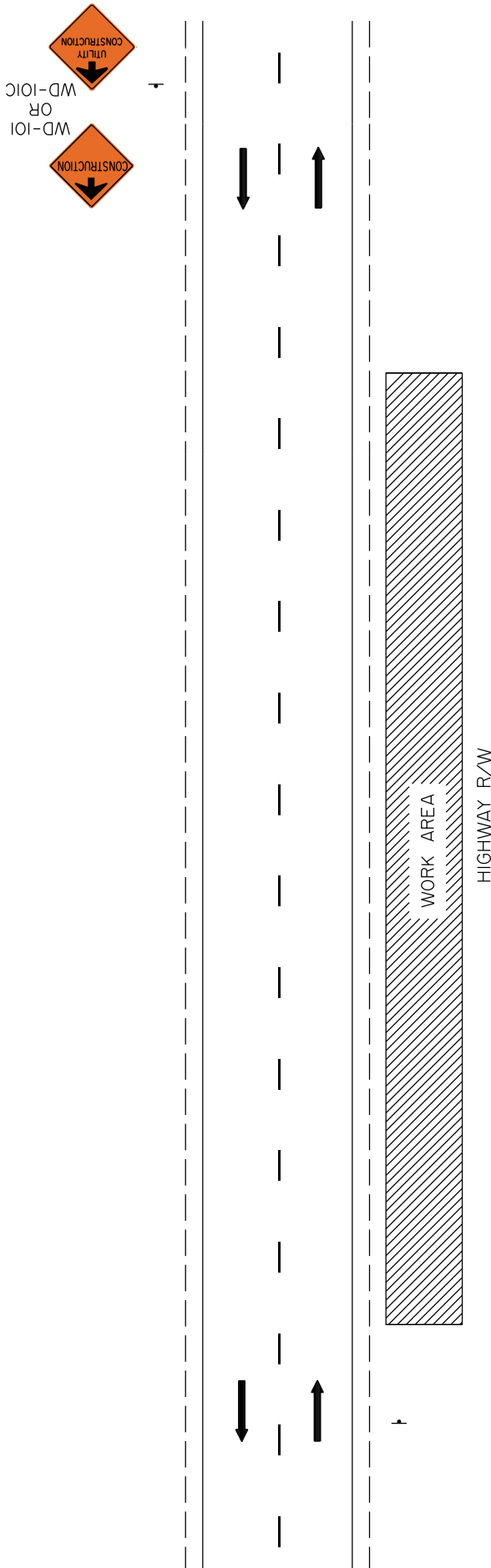

NOTES:

1. Each situation will require individual assessment, and consideration must be given to traffic volume, sight distances, sign spacing, duration of work and other factors to ensure traffic control devices are adequate in each instance.
2. All sign spacing shall be 100m-150m unless otherwise indicated.
3. No vehicles shall be parked on the road surface.
4. Materials or equipment may only be placed or stored on the outside backslope in a position to reduce damages to vehicles that may run off the roadway.
- △ 5. If working outside of the clear zone, signage may not be required.
6. All signs shall be kept clean and in good condition. The bottom of the sign shall not be less than 0.3m above the road surface.
7. During periods when no work is being actively performed, all non-applicable signs are to be removed or suitably covered

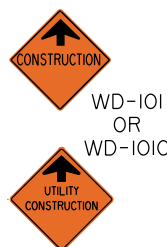

△			
△			
△	Note added and Title Block updated.	JM	Dec 31/07
No.	REVISIONS	BY	DATE
Approved:			
Original signed by Tim Hawnt			
Executive Director, Technical Standards Branch			
Date:	MARCH, 2001		
UTILITIES CONSTRUCTION - SIGNING △ WORK OFF ROAD SURFACE TWO LANE UNDIVIDED HIGHWAY			
Prepared By: G.E.C.	Checked By: P.H.	Scale: N.T.S.	Dwg No.: TCS-B-5.1A

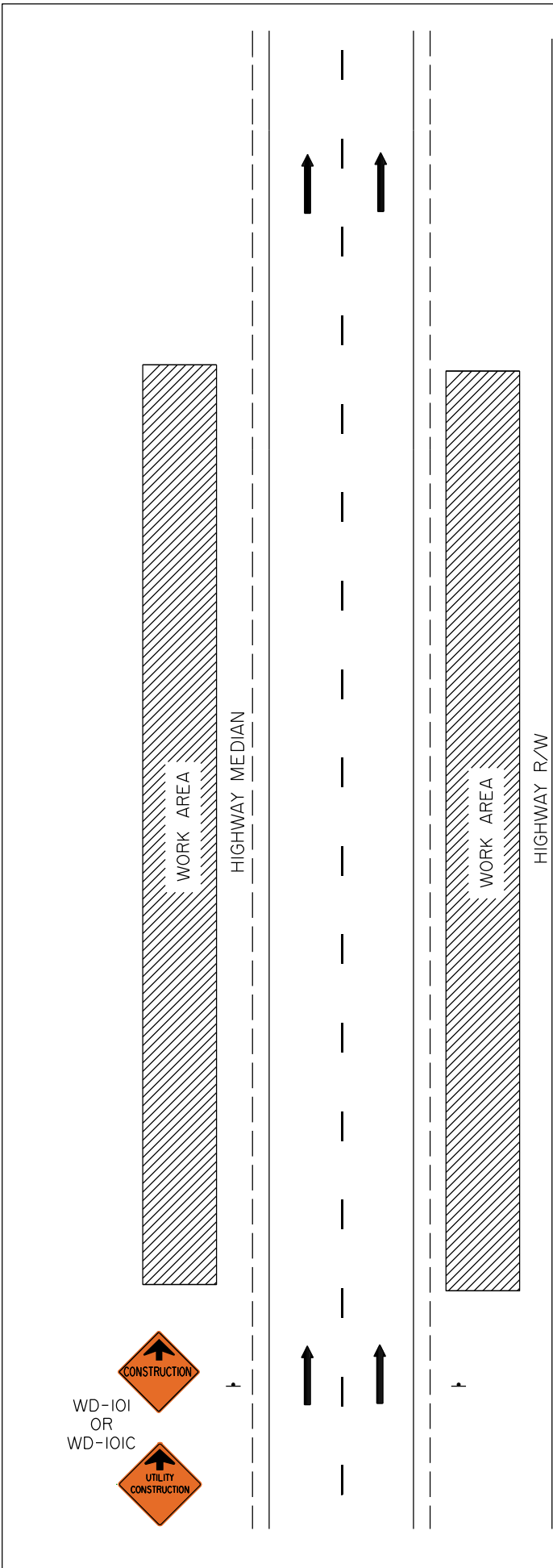

NOTES:

1. Each situation will require individual assessment, and consideration must be given to traffic volume, sight distances, sign spacing, duration of work and other factors to ensure traffic control devices are adequate in each instance.
2. All sign spacing shall be 100m-150m unless otherwise indicated.
3. No vehicles shall be parked on the road surface.
4. Materials or equipment may only be placed or stored on the outside backslope in a position to reduce damages to vehicles that may run off the roadway.
5. Materials or equipment shall not be stored in the median.
6. If working outside of the clear zone, signage may not be required. △
7. All signs shall be kept clean and in good condition. The bottom of the sign shall not be less than 0.3m above the road surface.
8. During periods when no work is being actively performed, all non-applicable signs are to be removed or suitably covered

△			
△			
△	Note added and Title Block updated.	JM	Dec 31/07
No.	REVISIONS	BY	DATE
Original signed by Tim Hawnt Executive Director, Technical Standards Branch		<i>Alberta</i>	
Date:	MARCH, 2001		
UTILITIES CONSTRUCTION - SIGNING △ WORK OFF ROAD SURFACE FOUR LANE DIVIDED HIGHWAY			
Prepared By: G.E.C.	Checked By: P.H.	Scale: N.T.S.	Dwg No.: TCS-B-5.1B



NOTE:  
 DETAILS OF  
 WARNING/REGULATORY  
 SIGNS SAME AS  
 THOSE ON OTHER  
 SIDE OF THE HIGHWAY

CONES ON TANGENT  
 50m SPACING

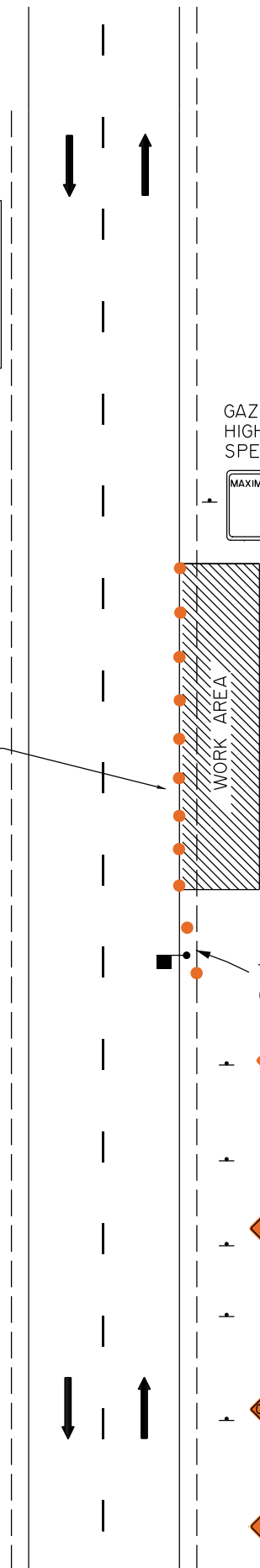

NOTES:

1. Each situation will require individual assessment, and consideration must be given to traffic volume, sight distances, sign spacing, duration of work and other factors to ensure traffic control devices are adequate in each instance.
2. All sign spacing shall be 100m-150m unless otherwise indicated.
3. No vehicles shall be parked on the driving lanes. When it is necessary to park vehicles on the shoulder of the road, they shall be marked by traffic cones.
4. If equipment is being moved across the roadway,  $\Delta$  WD-A-21 and a traffic control person shall be used.
5. All signs shall be kept clean and in good condition.  $\Delta$  The bottom of the sign shall not be less than 0.3m above the road surface.
6. During periods when no work is being actively performed, all non-applicable signs are to be removed or suitably covered.
7. Materials or equipment may be placed or stored adjacent to the highway property line if required.  $\Delta$

$\Delta$			
$\Delta$	Note and signs updated.	EY	Nov 30/18
$\Delta$	Signs added/deleted and notes and Title Block updated.	JM	Dec 31/07
No.	REVISIONS	BY	DATE

Approved:  
 Original signed by  
 Tim Hawnt  
 Executive Director,  
 Technical Standards Branch

Date: MARCH, 2001

UTILITIES CONSTRUCTION - SIGNING  $\Delta$   
 WORK ON SHOULDER  
 TWO LANE UNDIVIDED HIGHWAY

Prepared By: G.E.C.	Checked By: P.H.	Scale: N.T.S.	Dwg No.: TCS-B-5.2A
---------------------	------------------	---------------	---------------------

NOTES:

1. Each situation will require individual assessment, and consideration must be given to traffic volume, sight distances, sign spacing, duration of work and other factors to ensure traffic control devices are adequate in each instance.
2. All sign spacing shall be 100m-150m unless otherwise indicated.
3. No vehicles shall be parked on the driving lanes. When it is necessary to park vehicles on the shoulder of the road, they shall be marked by traffic cones.
4. If equipment is being moved across the roadway, WD-A-21 and a traffic control person shall be used.
5. All signs shall be kept clean and in good condition. The bottom of the sign shall not be less than 0.3m above the road surface.
6. During periods when no work is being actively performed, all non-applicable signs are to be removed or suitably covered.
7. Materials or equipment may be placed or stored adjacent to the highway property line if required.
8. Materials or equipment shall not be stored in the median.

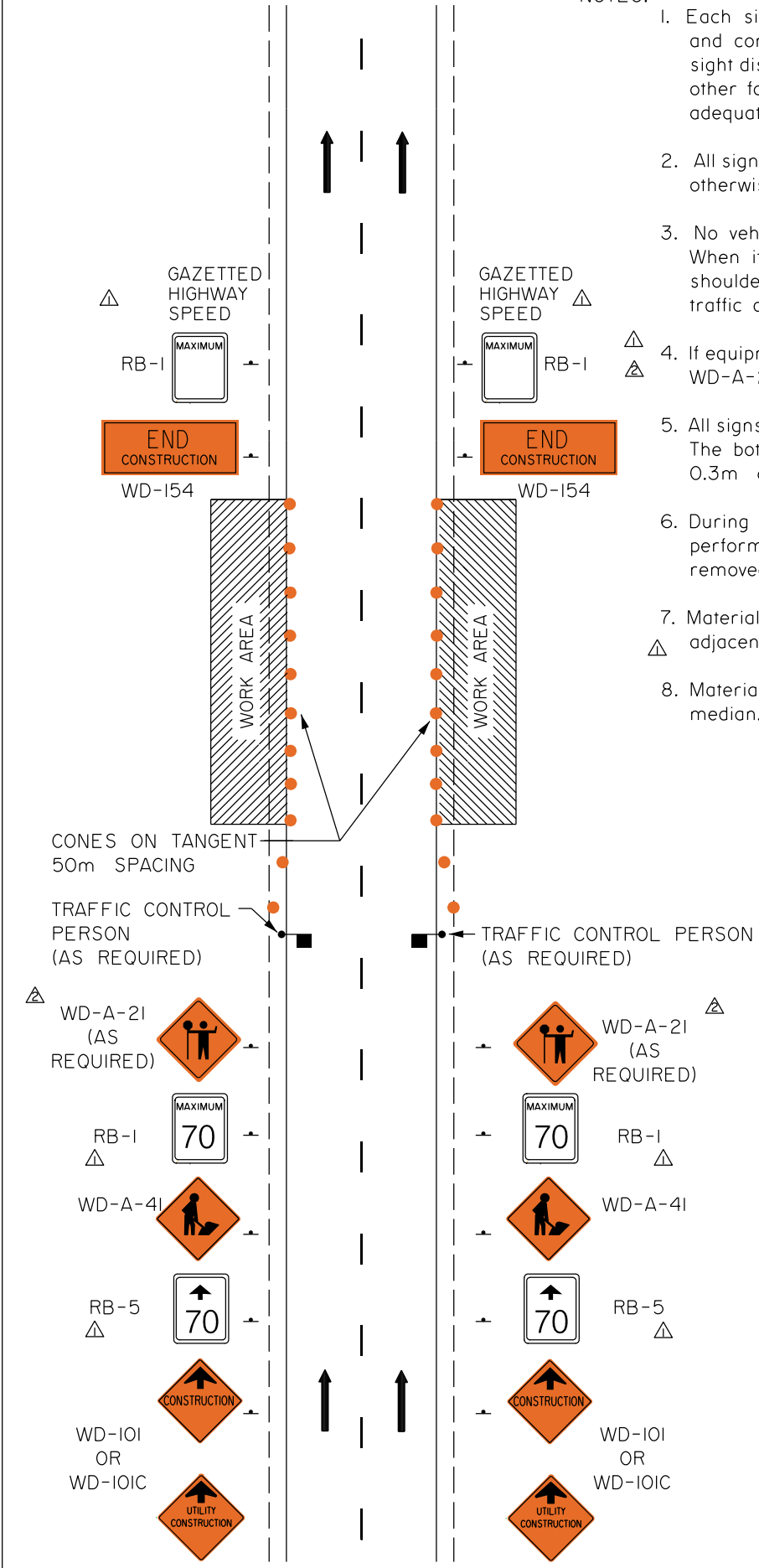

△			
△	Note and signs updated.	EY	Nov 30/18
△	70 km/h added, note deleted and Title Block updated.	JM	Dec 31/07
No.	REVISIONS	BY	DATE
Approved:			
Original signed by Tim Hawnt			
Executive Director, Technical Standards Branch			
Date:	MARCH, 2001		
UTILITIES CONSTRUCTION - SIGNING △ WORK ON SHOULDER FOUR LANE DIVIDED HIGHWAY			
Prepared By: G.E.C.	Checked By: P.H.	Scale: N.T.S.	Dwg No.: TCS-B-5.2B

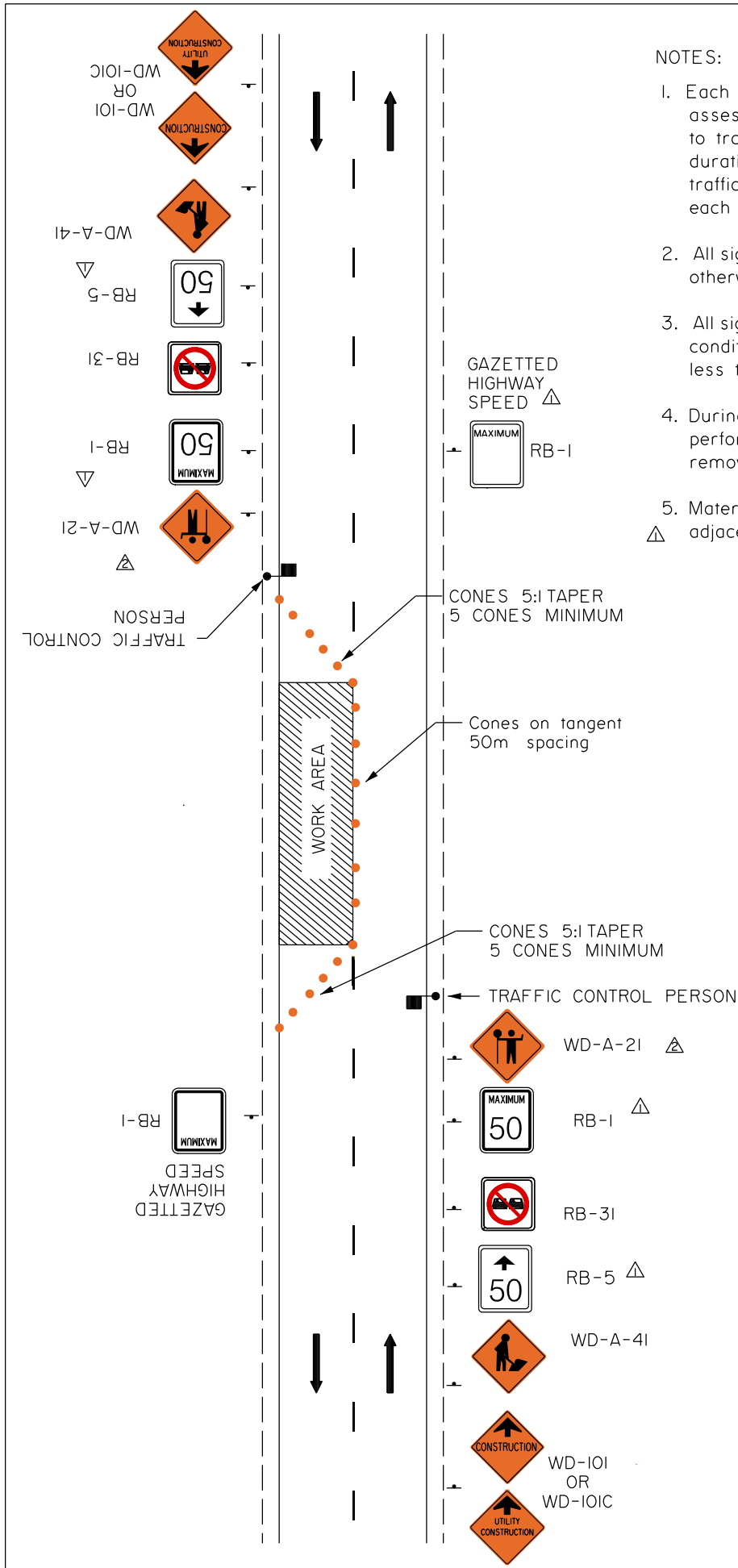

NOTES:

1. Each situation will require individual assessment, and consideration must be given to traffic volume, sight distances, sign spacing, duration of work and other factors to ensure traffic control devices are adequate in each instance.
2. All sign spacing shall be 100m-150m unless otherwise indicated.
3. All signs shall be kept clean and in good condition. The bottom of the sign shall not be less than 0.3m above the road surface.
4. During periods when no work is being actively performed, all non-applicable signs are to be removed or suitably covered.
5. Materials or equipment may be placed or stored adjacent to the highway property line if required.

△			
△	Signs updated.	EY	Nov 30/18
△	Signs added/deleted, notes and Title Block updated.	JM	Dec 31/07
No.	REVISIONS	BY	DATE
Approved:			
Original signed by Tim Hawnt			
Executive Director, Technical Standards Branch			
Date: MARCH, 2001			
UTILITIES CONSTRUCTION - SIGNING ONE LANE CLOSURE △ (ONE LANE ALTERNATING TRAFFIC) TWO LANE UNDIVIDED HIGHWAY			
Prepared By: G.E.C.	Checked By: P.H.	Scale: N.T.S.	Dwg No.: TCS-B-5.3A

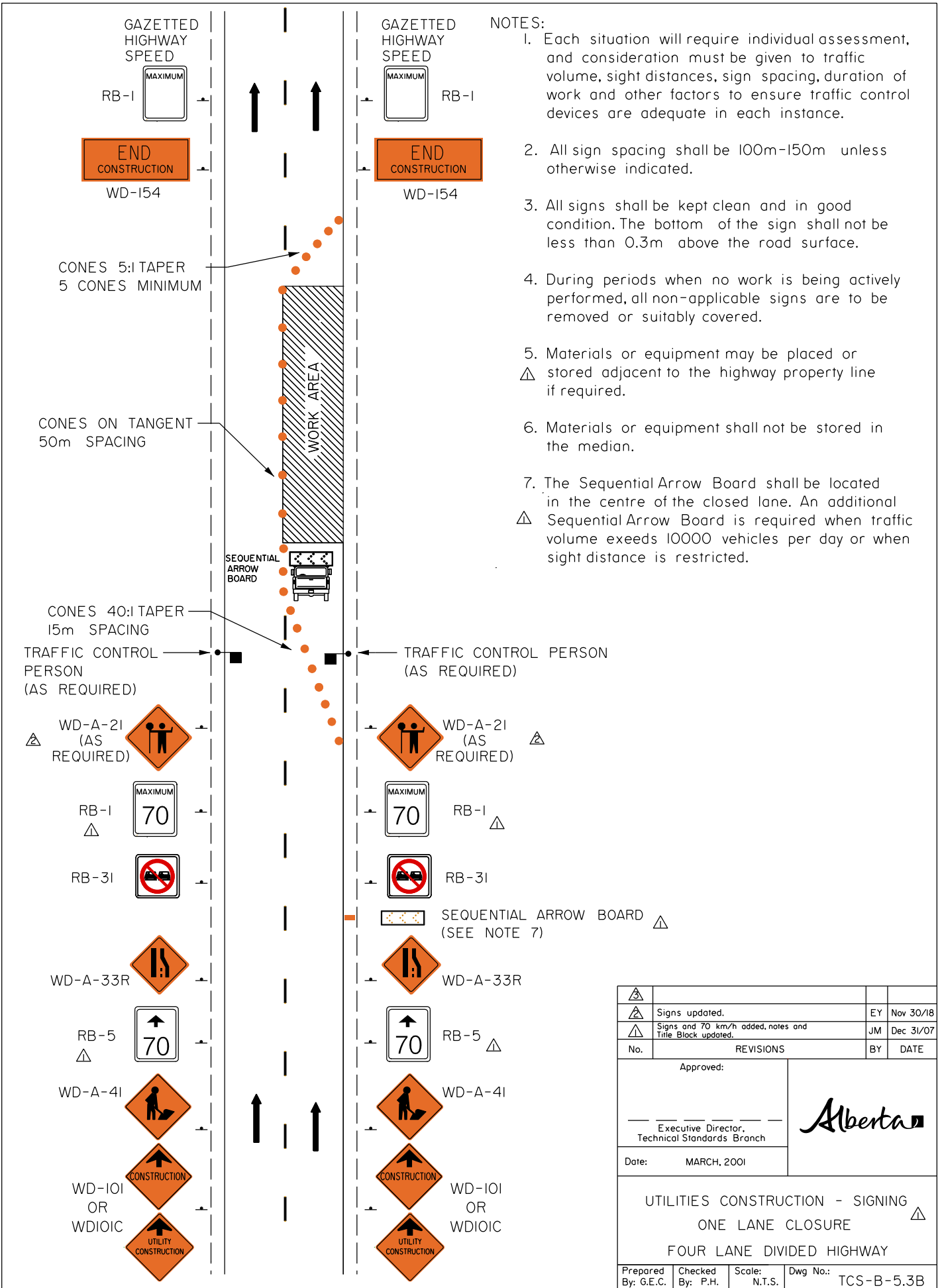

**TRAFFIC ACCOMMODATION IN URBAN WORK ZONES****LIST OF DRAWINGS**

Click the links below to get to the drawings. To go back to the Drawings by Category Table of Contents: click [here](#)

<b>URBAN HIGHWAYS- HIGH SPEED/HIGH VOLUME</b>	
<b>TCS-B Drawing No.</b>	<b>Description</b>
<a href="#">6.1B</a>	<a href="#">Left Lane Closure</a>
<a href="#">6.2B</a>	<a href="#">Right Lane Closure</a>
<a href="#">6.3B</a>	<a href="#">Centre and Right Lane Closure</a>
<a href="#">6.4B</a>	<a href="#">Centre and Left Lane Closure</a>
<a href="#">6.5B</a>	<a href="#">Detour Four Lane to Opposing Traffic</a>
<a href="#">6.6B</a>	<a href="#">Work on Shoulder</a>
<a href="#">6.7B</a>	<a href="#">Localized Excavation Adjacent to Shoulder (Within Work Zone)</a>
<a href="#">6.8B</a>	<a href="#">Ramp to One-Lane Closure (Free-Flow)</a>
<a href="#">6.9B</a>	<a href="#">Ramp to Two-Lane Closure</a>
<a href="#">6.10B</a>	<a href="#">3 Lane Closure to Off-Ramp</a>
<a href="#">6.11B</a>	<a href="#">Full Closure to Detour</a>
<a href="#">6.12A</a>	<a href="#">Detour</a>

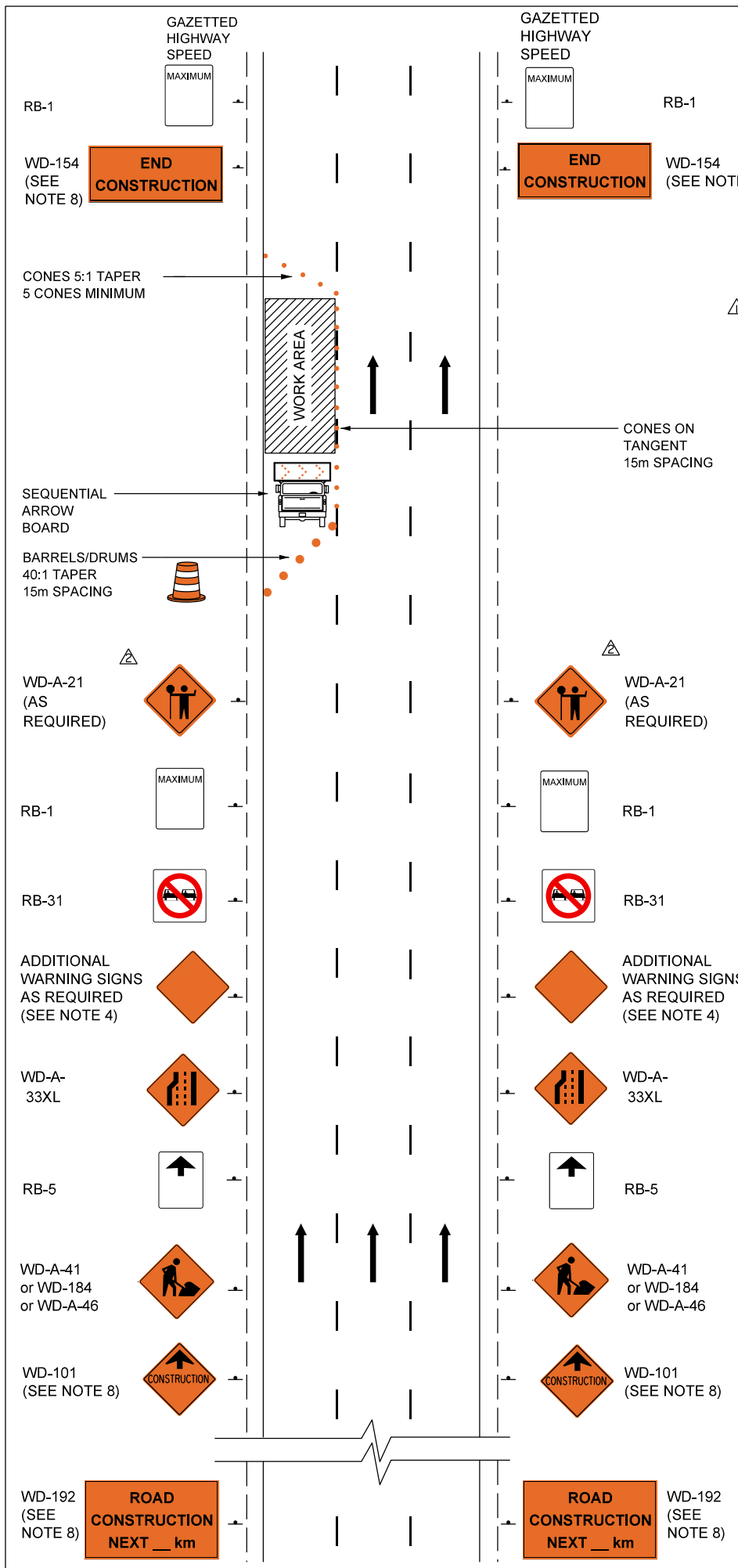

**NOTES:**

1. Consideration must be given to traffic volume, sight distances, sign spacing, duration of work, night time conditions and other factors to ensure traffic control devices are adequate in each instance.
2. All sign spacing shall be 100m-150m unless otherwise indicated.
3. Speed limit and warning signs shall be placed after every intersecting roadway throughout the work area where there is a restricted speed zone.
4. Examples of additional warning signs that may be required in conjunction with this plan are:

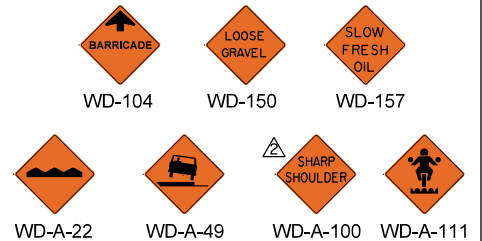

5. Other hazard signs as shown in the schedule of signs may be used as required.

6. Electronic variable message board is required when average summer daily traffic (ASDT) volume exceeds 10,000 vehicles per day or when sight distance is restricted.

7. WD-192 shall be erected 2km in advance or the distance may be adjusted due to site specific requirements of the project. Distance tab to include project length plus setback from project limit.

8. WD-192, WD-101, WD-154 signs are not required for short duration work.

9. WD-184 WD-A-46

	Signs updated.	EY	Nov 30/18
	Title Block and notes updated.	JM	Dec 31/07
No.	REVISIONS	BY	DATE

Approved:

ORIGINAL SIGNED  
BY ALLAN KWAN

Executive Director,  
Technical Standards Branch

Date: MARCH, 2003

HIGH SPEED / HIGH VOLUME -  
SIGNING FOR URBAN AREAS  
LEFT LANE CLOSURE

Prepared By: M.E.T.	Checked By: J.M.	Scale: N.T.S.	Dwg No.: TCS-B-6.1B
---------------------	------------------	---------------	---------------------

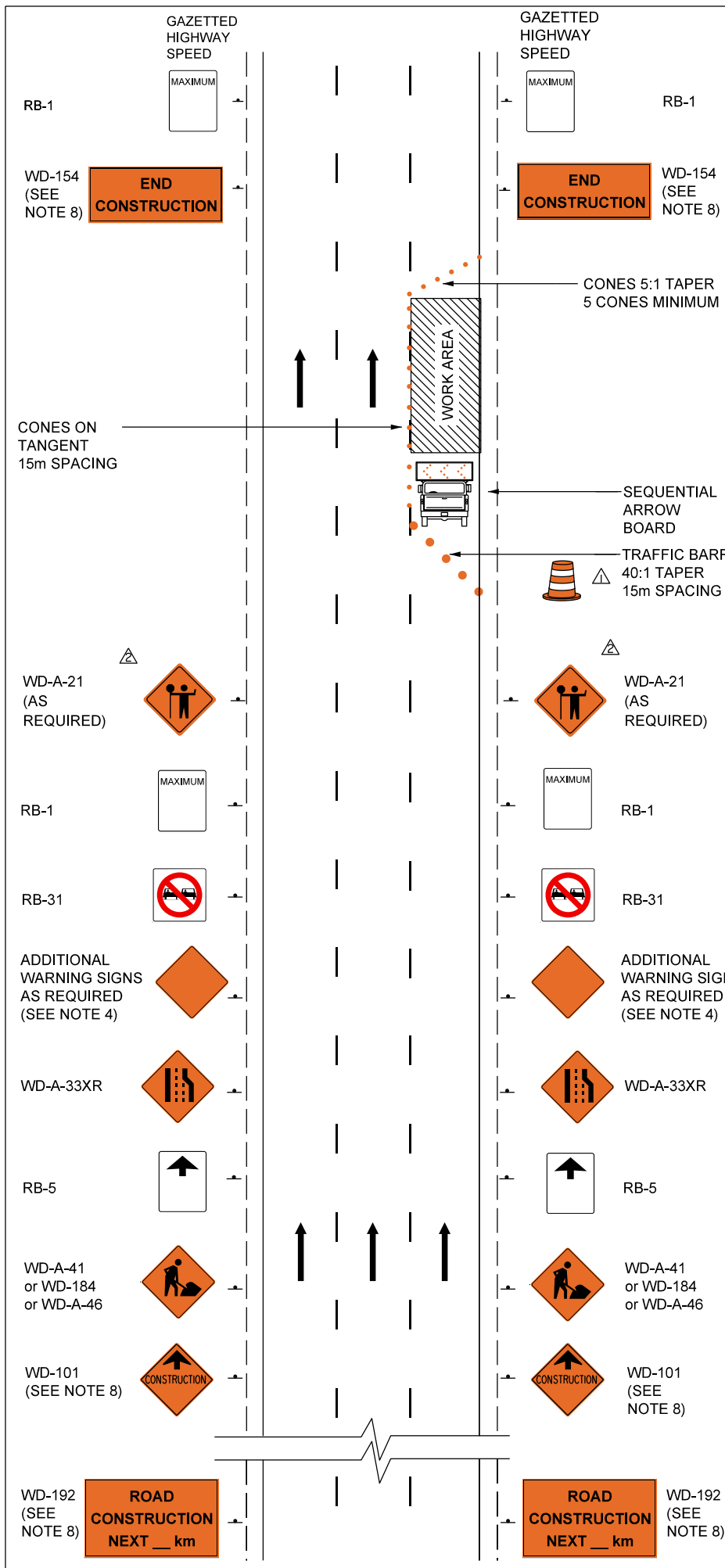

**NOTES:**

1. Consideration must be given to traffic volume, sight distances, sign spacing, duration of work, night time conditions and other factors to ensure traffic control devices are adequate in each instance.
2. All sign spacing shall be 100m-150m unless otherwise indicated.
3. Speed limit and warning signs shall be placed after every intersecting roadway throughout the work area where there is a restricted speed zone.
4. Examples of additional warning signs that may be required in conjunction with this plan are:
5. Other hazard signs as shown in the schedule of signs may be used as required.
6. Electronic variable message board is required when average summer daily traffic (ASDT) volume exceeds 10,000 vehicles per day or when sight distance is restricted.
7. WB-192 shall be erected 2km in advance or the distance may be adjusted due to site specific requirements of the project. Distance tab to include project length plus setback from project limit.
8. WB-192, WB-101, WB-154 signs are not required for short duration work.

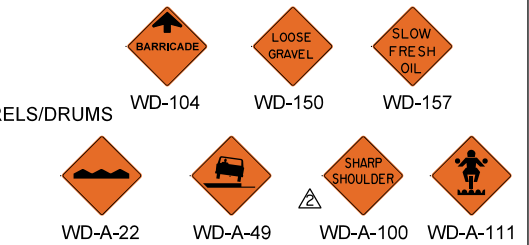

9.
  - WB-184 (Testing Crew)
  - WB-A-46 (Worker with shovel)

△			
△	Signs updated.	EY	Nov 30/18
△	Title Block and notes updated.	JM	Dec 31/07
No.	REVISIONS	BY	DATE

Approved:

ORIGINAL SIGNED  
BY ALLAN KWAN

Executive Director,  
Technical Standards Branch

Date: MARCH, 2003

HIGH SPEED / HIGH VOLUME -  
SIGNING FOR URBAN AREAS  
RIGHT LANE CLOSURE





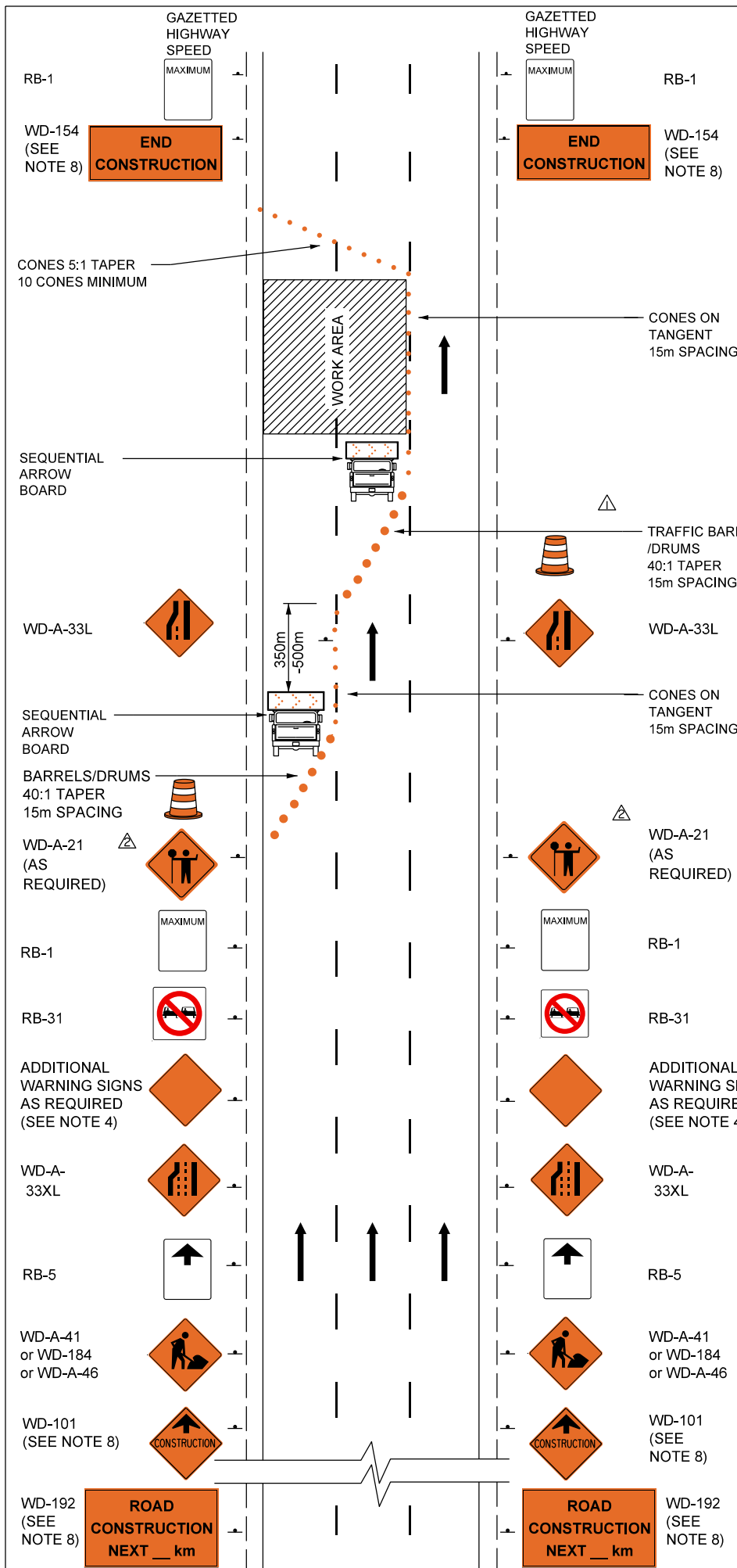

**NOTES:**

1. Consideration must be given to traffic volume, sight distances, sign spacing, duration of work, night time conditions and other factors to ensure traffic control devices are adequate in each instance.
2. All sign spacing shall be 100m-150m unless otherwise indicated.
3. Speed limit and warning signs shall be placed after every intersecting roadway throughout the work area where there is a restricted speed zone.
4. Examples of additional warning signs that may be required in conjunction with this plan are:
5. Other hazard signs as shown in the schedule of signs may be used as required.
6. Electronic variable message board is required when average summer daily traffic (ASDT) volume exceeds 10,000 vehicles per day or when sight distance is restricted.
7. WD-192 shall be erected 2km in advance or the distance may be adjusted due to site specific requirements of the project. Distance tab to include project length plus setback from project limit.
8. WD-192, WD-101, WD-154 signs are not required for short duration work.

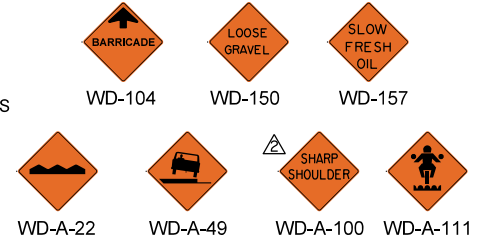

△			
△	Signs updated.	EY	Nov 30/18
△	Title Block and notes updated.	JM	Dec 31/07
No.	REVISIONS	BY	DATE



Approved:  
 ORIGINAL SIGNED BY ALLAN KWAN  
 Executive Director, Technical Standards Branch  
 Date: MARCH, 2003

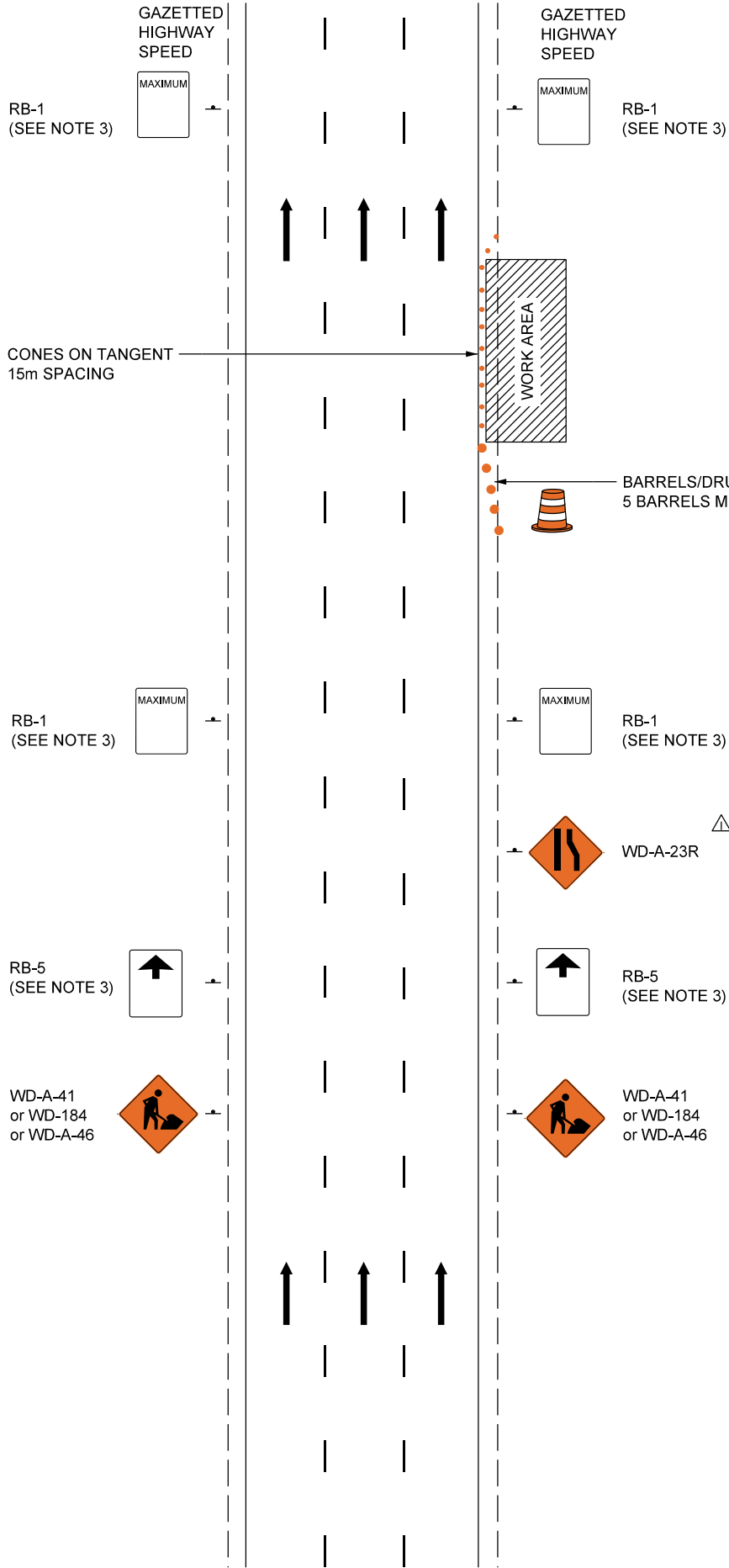

HIGH SPEED / HIGH VOLUME - SIGNING FOR URBAN AREAS CENTRE AND LEFT LANE CLOSURE





**NOTES:**

1. Consideration must be given to traffic volume, sight distances, sign spacing, duration of work and other factors to ensure traffic control devices are adequate in each instance.
2. All sign spacing shall be 100m-150m unless otherwise indicated.
3. RB-5 and RB-1 signs will be required where a reduced speed zone is in place.
4.    
WD-184      WD-A-46
5. Delineators/Cones shall be placed at 15m spacing. If the drop-off has slope flatter than 3:1, cones are not required.

	Title Block, notes updated and sign added.	JM	Dec 31/07
No.	REVISIONS	BY	DATE
Approved:			
ORIGINAL SIGNED BY ALLAN KWAN			
Executive Director, Technical Standards Branch			
Date:	MARCH, 2003		
HIGH SPEED / HIGH VOLUME - SIGNING FOR URBAN AREAS  WORK ON SHOULDER			
Prepared By: M.E.T.	Checked By: J.M.	Scale: N.T.S.	Dwg No.: TCS-B-6.6B

NOTES:

1. Consideration must be given to traffic volume, sight distances, sign spacing, duration of work and other factors to ensure traffic control devices are adequate in each instance.
2. All sign spacing shall be 100m-150m unless otherwise indicated.
3. Temporary traffic barriers shall be Approved Continuous Precast Concrete F-shaped Barriers (refer to Alberta Transportation's Roadside Design Guide for the latest drawing CB6-4.2M16 or approved equivalent) meeting the requirements of NCHRP 350 Test Level 3, with proper consideration for deflection allowance behind barriers. The barriers shall be placed on pavement or properly prepared granular base.
4. The exposed ends of the barriers shall be protected by crash attenuators on Alberta Transportation's product list. If sand barrels are considered, it must be approved by the department (refer to Roadside Design Guide for the latest drawing TEB 3.19).
5. Alternatively, the barriers may be terminated outside the clear zone (refer to drawing TCS-B-1.29).

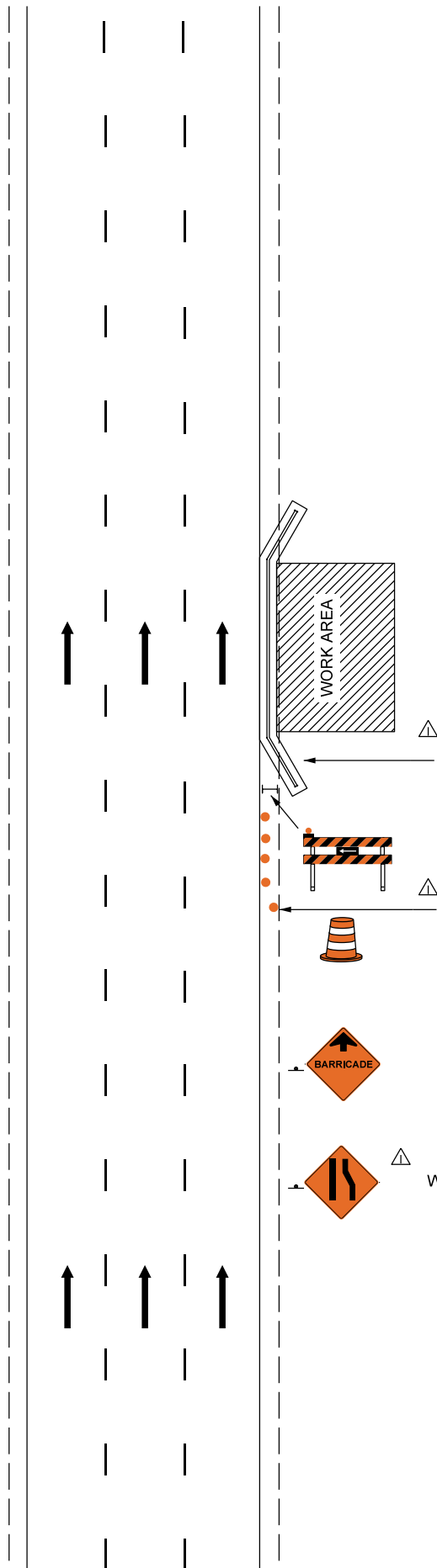

PRECAST CONCRETE F-SHAPED BARRIERS  
C/W TYPE "C" STEADY BURN LIGHTS OR REFLECTORIZED MARKERS  
AT 15m SPACING ON TANGENT

WD-116-1L

TRAFFIC BARRELS/DRUMS  
5 BARRELS MINIMUM



WD-104



WD-A-23R

△			
△	Notes updated.	EY	Nov 30/18
△	Title Block, notes updated and sign added.	JM	Dec 31/07
No.	REVISIONS	BY	DATE

Approved:  ORIGINAL SIGNED BY ALLAN KWAN  Executive Director, Technical Standards Branch  Date: MARCH, 2003	
---	--

HIGH SPEED / HIGH VOLUME -  
SIGNING FOR URBAN AREAS  
LOCALIZED EXCAVATION ADJACENT  
TO SHOULDER (WITHIN WORK ZONE) △

Prepared By: M.E.T.	Checked By: J.M.	Scale: N.T.S.	Dwg No.: TCS-B-6.7B
---------------------	------------------	---------------	---------------------

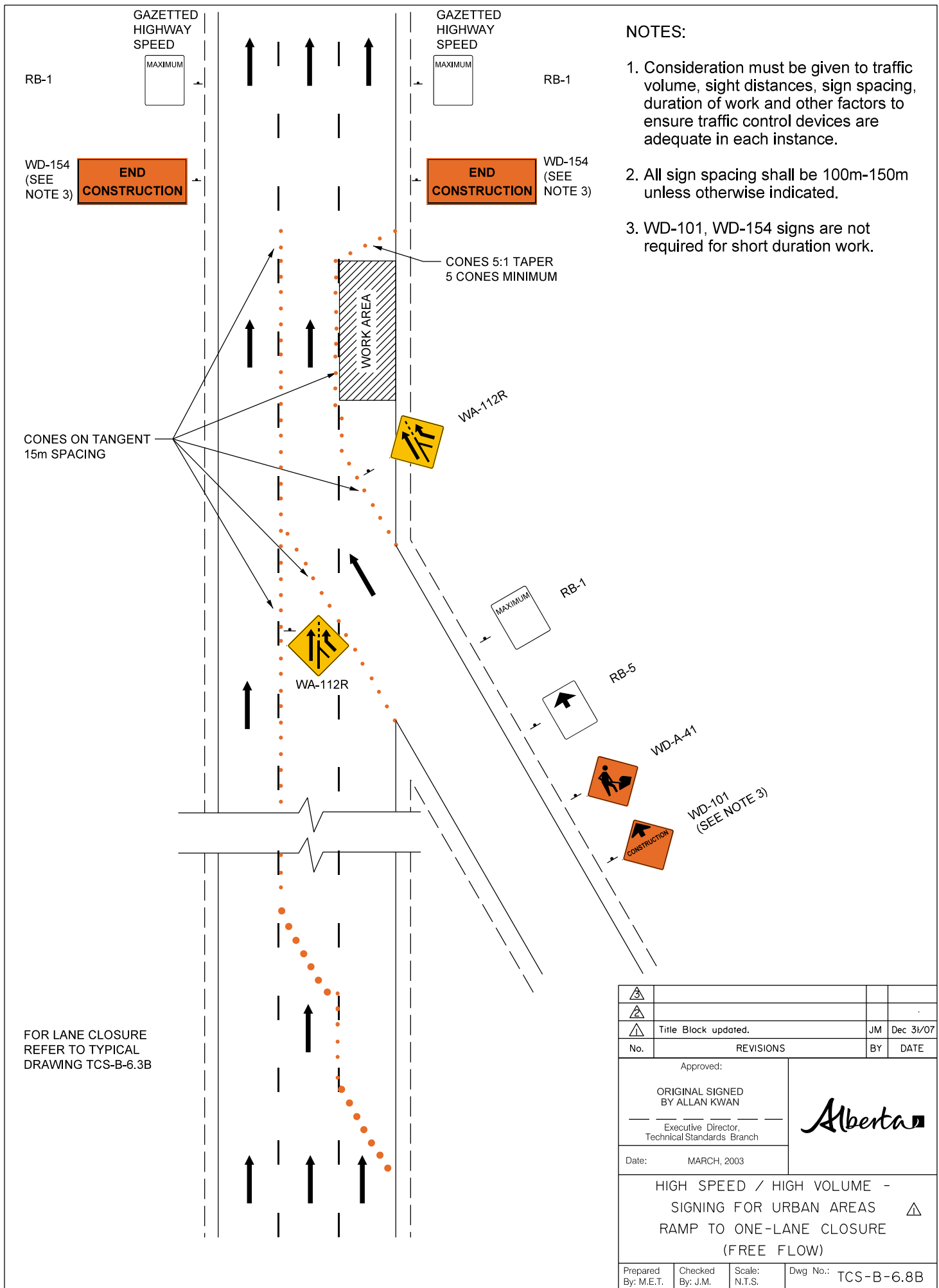

**NOTES:**

1. Consideration must be given to traffic volume, sight distances, sign spacing, duration of work and other factors to ensure traffic control devices are adequate in each instance.
2. All sign spacing shall be 100m-150m unless otherwise indicated.
3. WD-101, WD-154 signs are not required for short duration work.

RB-1

GAZETTED  
HIGHWAY  
SPEED



WD-154  
(SEE  
NOTE 3)



GAZETTED  
HIGHWAY  
SPEED



RB-1

WD-154  
(SEE  
NOTE 3)



CONES 5:1 TAPER  
5 CONES MINIMUM

CONES ON TANGENT  
15m SPACING

WA-112R

WA-112R

RB-1

RB-5

WB-A-41

WB-101  
(SEE NOTE 3)

FOR LANE CLOSURE  
REFER TO TYPICAL  
DRAWING TCS-B-6.3B

	Title Block updated.	JM	Dec 31/07
No.	REVISIONS	BY	DATE
Approved:			
ORIGINAL SIGNED BY ALLAN KWAN			
Executive Director, Technical Standards Branch			
Date:	MARCH, 2003		
HIGH SPEED / HIGH VOLUME - SIGNING FOR URBAN AREAS RAMP TO ONE-LANE CLOSURE (FREE FLOW)			
Prepared By: M.E.T.	Checked By: J.M.	Scale: N.T.S.	Dwg No.: TCS-B-6.8B

GAZETTED  
HIGHWAY  
SPEED

MAXIMUM

RB-1

WD-154  
(SEE  
NOTE 3)

**END  
CONSTRUCTION**

GAZETTED  
HIGHWAY  
SPEED

MAXIMUM

RB-1

WD-154  
(SEE  
NOTE 3)

**END  
CONSTRUCTION**

**NOTES:**

1. Consideration must be given to traffic volume, sight distances, sign spacing, duration of work and other factors to ensure traffic control devices are adequate in each instance.
2. All sign spacing shall be 100m-150m unless otherwise indicated.
3. WD-101, WD-154 signs are not required for short duration work.

CONES 5:1 TAPER  
10 CONES MINIMUM



CONES ON TANGENT  
15m SPACING

RA-2

MAXIMUM

RB-1

WB-2

RB-5

WD-A-41

WD-101  
(SEE NOTE 3)



FOR LANE CLOSURE  
REFER TO TYPICAL  
DRAWING TCS-B-6.3B

△			
△			
△	Title Block updated.	JM	Dec 31/07
No.	REVISIONS	BY	DATE

Approved:

ORIGINAL SIGNED  
BY ALLAN KWAN

Executive Director,  
Technical Standards Branch

Date: MARCH, 2003

HIGH SPEED / HIGH VOLUME -  
SIGNING FOR URBAN AREAS △  
RAMP TO TWO-LANE CLOSURE

Prepared By: M.E.T.	Checked By: J.M.	Scale: N.T.S.	Dwg No.: TCS-B-6.9B
------------------------	---------------------	------------------	------------------------

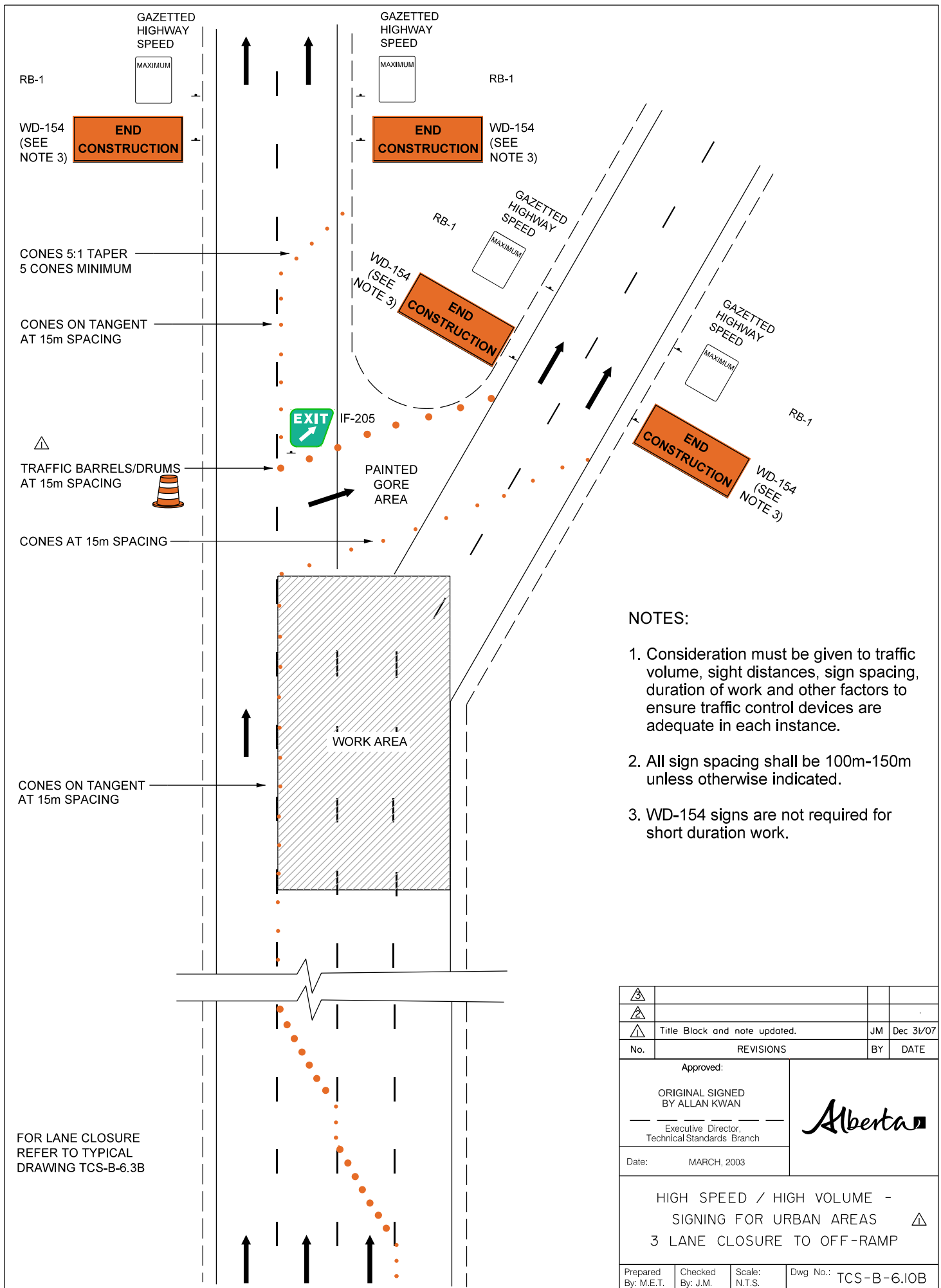

**NOTES:**

1. Consideration must be given to traffic volume, sight distances, sign spacing, duration of work and other factors to ensure traffic control devices are adequate in each instance.
2. All sign spacing shall be 100m-150m unless otherwise indicated.
3. WD-154 signs are not required for short duration work.

△			
△			
△	Title Block and note updated.	JM	Dec 31/07
No.	REVISIONS	BY	DATE
Approved:			
ORIGINAL SIGNED BY ALLAN KWAN			
Executive Director, Technical Standards Branch			
Date:	MARCH, 2003		
HIGH SPEED / HIGH VOLUME - SIGNING FOR URBAN AREAS △ 3 LANE CLOSURE TO OFF-RAMP			
Prepared By: M.E.T.	Checked By: J.M.	Scale: N.T.S.	Dwg No.: TCS-B-6.10B

NOTES:

1. Consideration must be given to traffic volume, sight distances, sign spacing, duration of work and other factors to ensure traffic control devices are adequate in each instance.
2. All sign spacing shall be 100m-150m unless otherwise indicated.
3. Highway shall be completely barricaded.

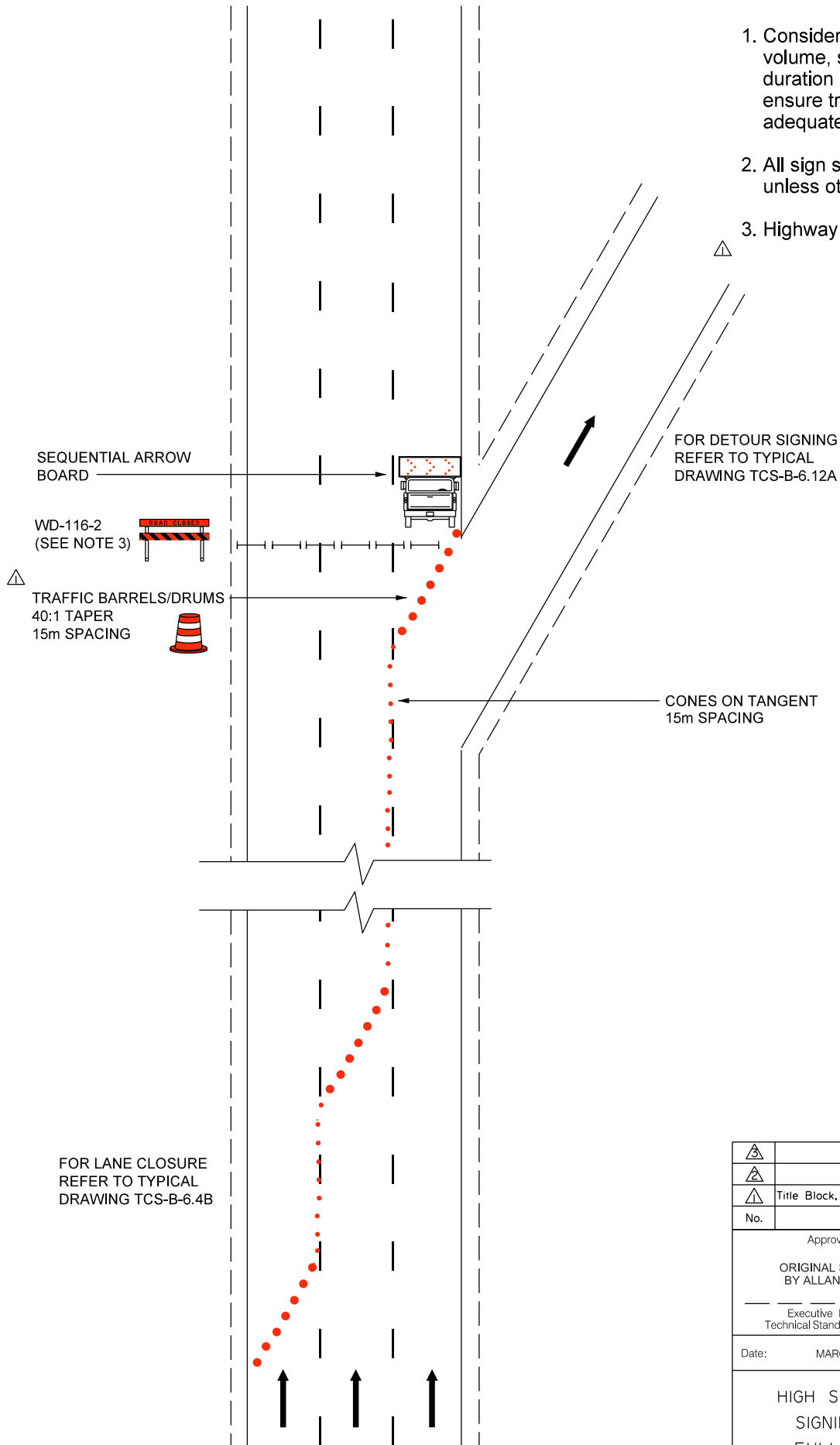

△			
△			
△	Title Block, notes updated; flashers eliminated, JM	Dec 31/07	
No.	REVISIONS	BY	DATE
Approved:			
ORIGINAL SIGNED BY ALLAN KWAN			
Executive Director, Technical Standards Branch			
Date:	MARCH, 2003		
HIGH SPEED / HIGH VOLUME - SIGNING FOR URBAN AREAS △ FULL CLOSURE TO DETOUR			
Prepared By: M.E.T.	Checked By: J.M.	Scale: N.T.S.	Dwg No.: TCS-B-6.IIB



NOTES:

1. Consideration must be given to traffic volume, sight distances, sign spacing, duration of work, night time conditions and other factors to ensure traffic control devices are adequate in each instance.
2. All sign spacing shall be 25m-100m unless otherwise indicated.
3. For all detours, customised plans will be required.
4. Intersection control must be determined for each intersection on the detour route and must conform to appropriate legislation.
5. Detour speed limit must be appropriate for each detour route.
6. During darkness, two Type "A" flashing lights shall be placed on each barricade.

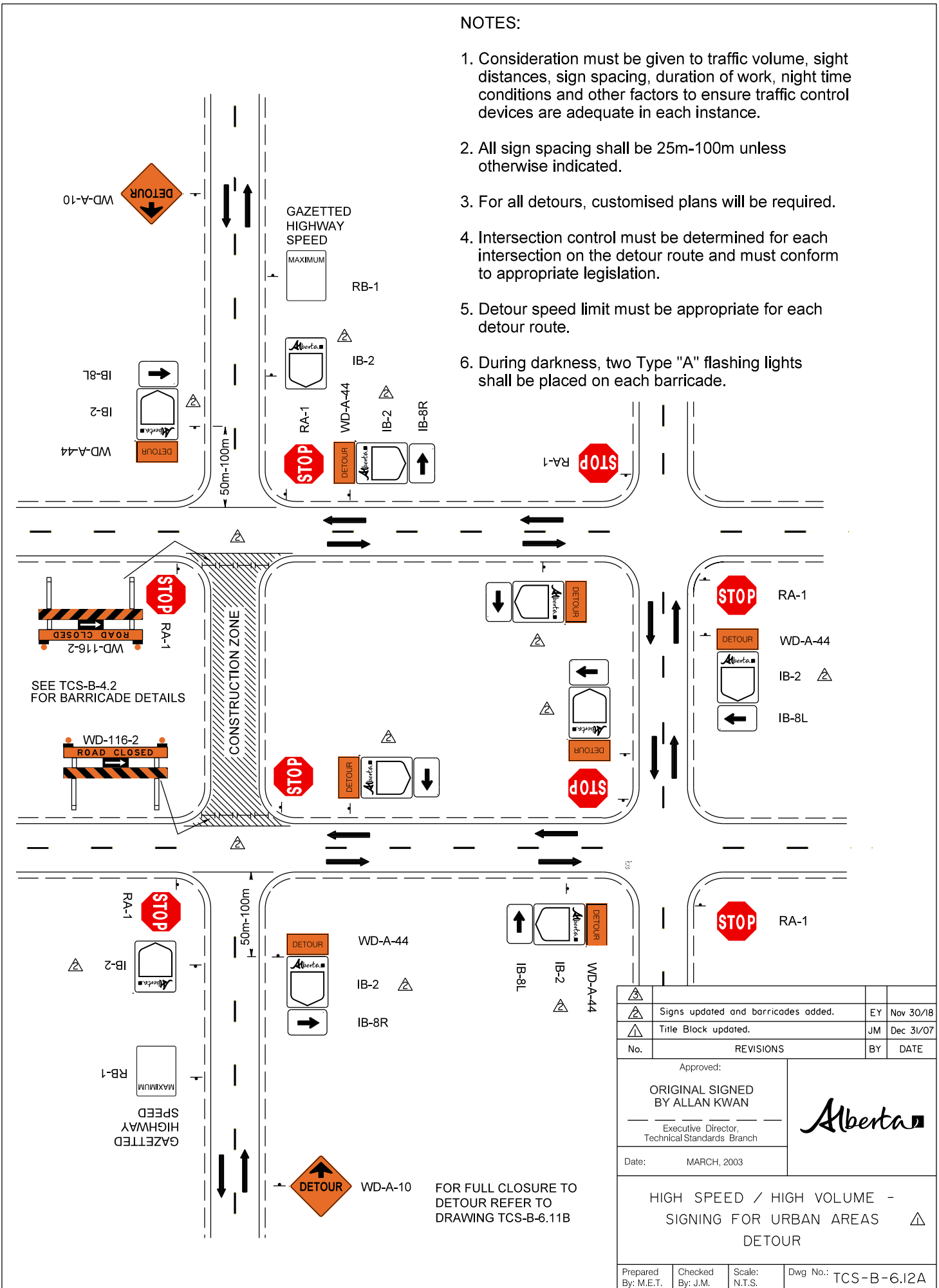

△			
△	Signs updated and barricades added.	EY	Nov 30/18
△	Title Block updated.	JM	Dec 31/07
No.	REVISIONS	BY	DATE

Approved:  
**ORIGINAL SIGNED BY ALLAN KWAN**  
 Executive Director,  
 Technical Standards Branch  
 Date: MARCH, 2003



HIGH SPEED / HIGH VOLUME -  
 SIGNING FOR URBAN AREAS △  
 DETOUR

Prepared By: M.E.T.	Checked By: J.M.	Scale: N.T.S.	Dwg No.: TCS-B-6.12A
---------------------	------------------	---------------	----------------------

## TRAFFIC ACCOMMODATION IN WORK ZONES

### LIST OF DRAWINGS

Click the links below to get to the drawings. To go back to the Drawings by Category Table of Contents: click [here](#)

URBAN HIGHWAYS- LOW SPEED/LOW VOLUME			
TCS-B Drawing No.	2 Lane Undivided	4 Lane Divided	Description
<a href="#">7.1A</a>	X		<a href="#">One Lane Closure (One Lane Alternating Traffic)</a>
<a href="#">7.2B</a>		X	<a href="#">Right Lane Closure</a>
<a href="#">7.3A</a>	X		<a href="#">Work on Shoulder</a>
<a href="#">7.3B</a>		X	<a href="#">Work on Shoulder</a>
<a href="#">7.4A</a>	X		<a href="#">Shoulder Drop-Off (Within Work Zone)</a>
<a href="#">7.4B</a>		X	<a href="#">Shoulder Drop-Off (Within Work Zone)</a>
<a href="#">7.5A</a>	X		<a href="#">Intersecting Roads</a>
<a href="#">7.5B</a>		X	<a href="#">Intersecting Roads</a>
<a href="#">7.6A</a>	X		<a href="#">Work on Centreline Two Lane Traffic</a>
<a href="#">7.7A</a>	X		<a href="#">Detour</a>
<a href="#">7.8A</a>	X		<a href="#">Embankment and Fixed Objects</a>
<a href="#">7.8B</a>		X	<a href="#">Embankment and Fixed Objects</a>
<a href="#">7.9A</a>	X		<a href="#">One Lane Closure (One Lane Alternating Traffic)</a>
<a href="#">7.9B</a>		X	<a href="#">One Lane Closure</a>
<a href="#">7.10B</a>		X	<a href="#">Two Lane Closure with 2-Way Traffic</a>

NOTES:

1. Consideration must be given to traffic volume, sight distances, sign spacing, duration of work, night time conditions and other factors to ensure traffic control devices are adequate in each instance.
2. All sign spacing shall be 25m-100m unless otherwise indicated.
3. For mobile operation, cones may not be required.
4. WD-101 and WD-154 sign not required for short duration work.
5. RB-31 sign not required when existing solid yellow barrier line is in place.
6. WD-194 sign, together with RA-2 sign, may be used instead of WD-A-21 sign and flagperson if sight distance is adequate.



RA-2



WD-194

7. RB-5 and RB-1 signs will be used when a reduced speed zone is required. In this case gazetted speed to be posted after the work area.



RB-5



RB-1

8. Other hazard signs as shown in the schedule of signs may be used as required.

9.



WD-184



WD-A-46

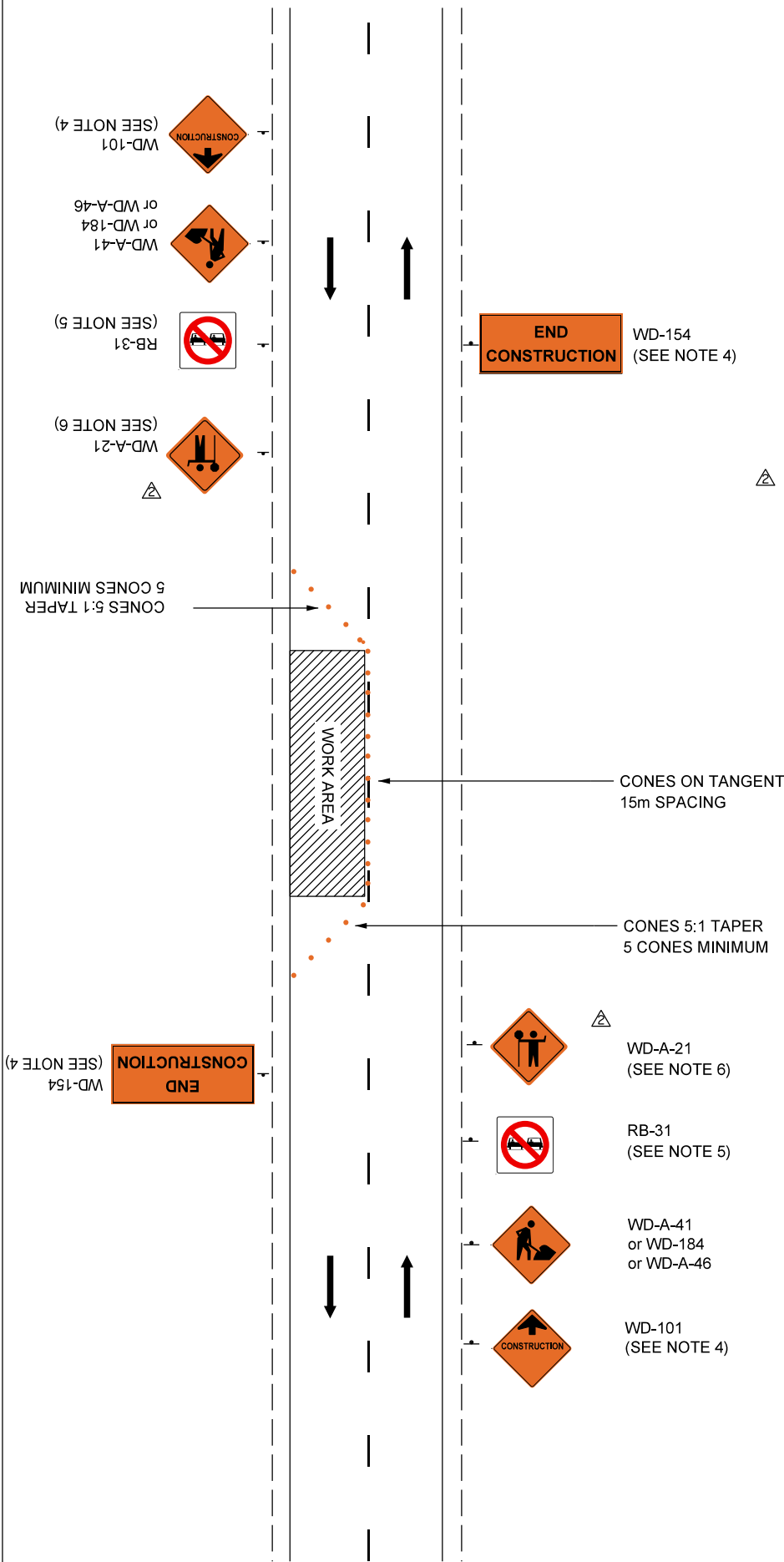

△			
△	Signs and note updated.	EY	Nov 30/18
△	Title Block updated.	JM	Dec 31/07
No.	REVISIONS	BY	DATE

Approved:

ORIGINAL SIGNED  
BY ALLAN KWAN

Executive Director,  
Technical Standards Branch

Date: MARCH, 2003



LOW SPEED / LOW VOLUME -  
SIGNING FOR URBAN AREAS △  
ONE LANE CLOSURE  
(ONE LANE ALTERNATING TRAFFIC)  
TWO LANE UNDIVIDED HIGHWAY

Prepared By: M.E.T.	Checked By: J.M.	Scale: N.T.S.	Dwg No.: TCS-B-7.1A
---------------------	------------------	---------------	---------------------

**NOTES:**

1. Consideration must be given to traffic volume, sight distances, sign spacing, duration of work, night time conditions and other factors to ensure traffic control devices are adequate in each instance.
2. All sign spacing shall be 25m-100m unless otherwise indicated.
3. For mobile operation, cones may not be required.
4. WD-101 and WD-154 signs not required for short duration work.
5. RB-5 and RB-1 signs will be used when a reduced speed zone is required. In this case gazetted speed to be posted after the work area.



6. If construction operation is occurring on the opposite travel lanes, then applicable construction signing will also be required on those lanes.
7. Other hazard signs as shown in the schedule of signs may be used as required.



9. The Sequential Arrow Board should be located in the centre of the closed lane.

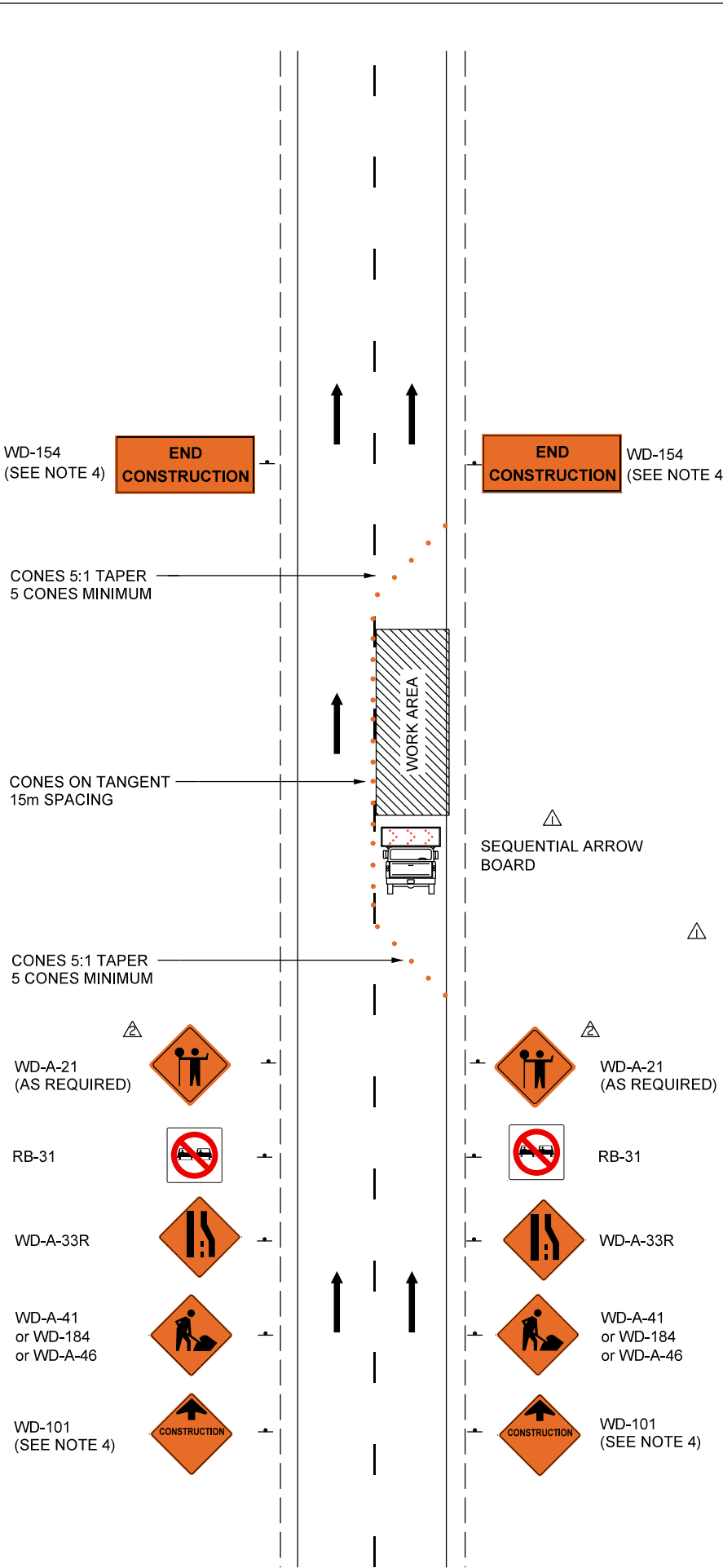

	Signs updated.	EY	Nov 30/18
	Title Block updated, barricade removed and sequential arrow board and note added.	JM	Dec 31/07
No.	REVISIONS	BY	DATE
Approved:			
ORIGINAL SIGNED BY ALLAN KWAN			
Executive Director, Technical Standards Branch			
Date:	MARCH, 2003		
LOW SPEED / LOW VOLUME - SIGNING FOR URBAN AREAS RIGHT LANE CLOSURE FOUR LANE DIVIDED HIGHWAY			
Prepared By: M.E.T.	Checked By: J.M.	Scale: N.T.S.	Dwg No.: TCS-B-7.2B

**NOTES:**

1. Consideration must be given to traffic volume, sight distances, sign spacing, duration of work, night time conditions and other factors to ensure traffic control devices are adequate in each instance.
2. All sign spacing shall be 25m-100m unless otherwise indicated.
3. For mobile operation, cones may not be required.
4. WD-101 and WD-154 signs not required for short duration work.
5. RB-5 and RB-1 signs will be used when a reduced speed zone is required. In this case gazetted speed to be posted after the work area.



RB-5



RB-1

6. Other hazard signs as shown in the schedule of signs may be used as required.

7.



WD-184



WD-A-46

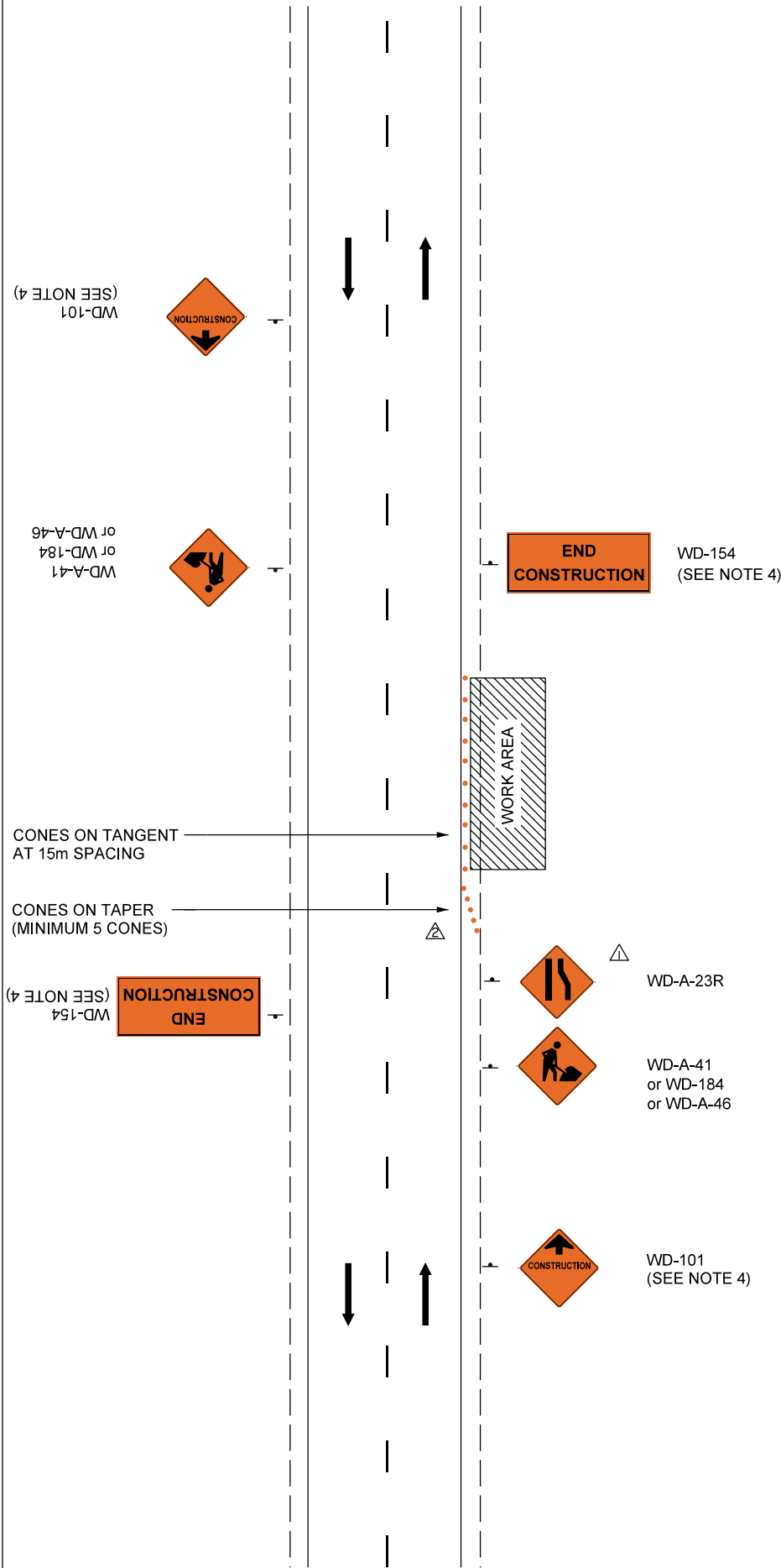

	Cone points added.	EY	Nov 30/18
	Title Block updated and sign added.	JM	Dec 31/07
No.	REVISIONS	BY	DATE
Approved:			
ORIGINAL SIGNED BY ALLAN KWAN			
Executive Director, Technical Standards Branch			
Date:	MARCH, 2003		
LOW SPEED / LOW VOLUME - SIGNING FOR URBAN AREAS WORK ON SHOULDER TWO LANE UNDIVIDED HIGHWAY			
Prepared By: M.E.T.	Checked By: J.M.	Scale: N.T.S.	Dwg No.: TCS-B-7.3A

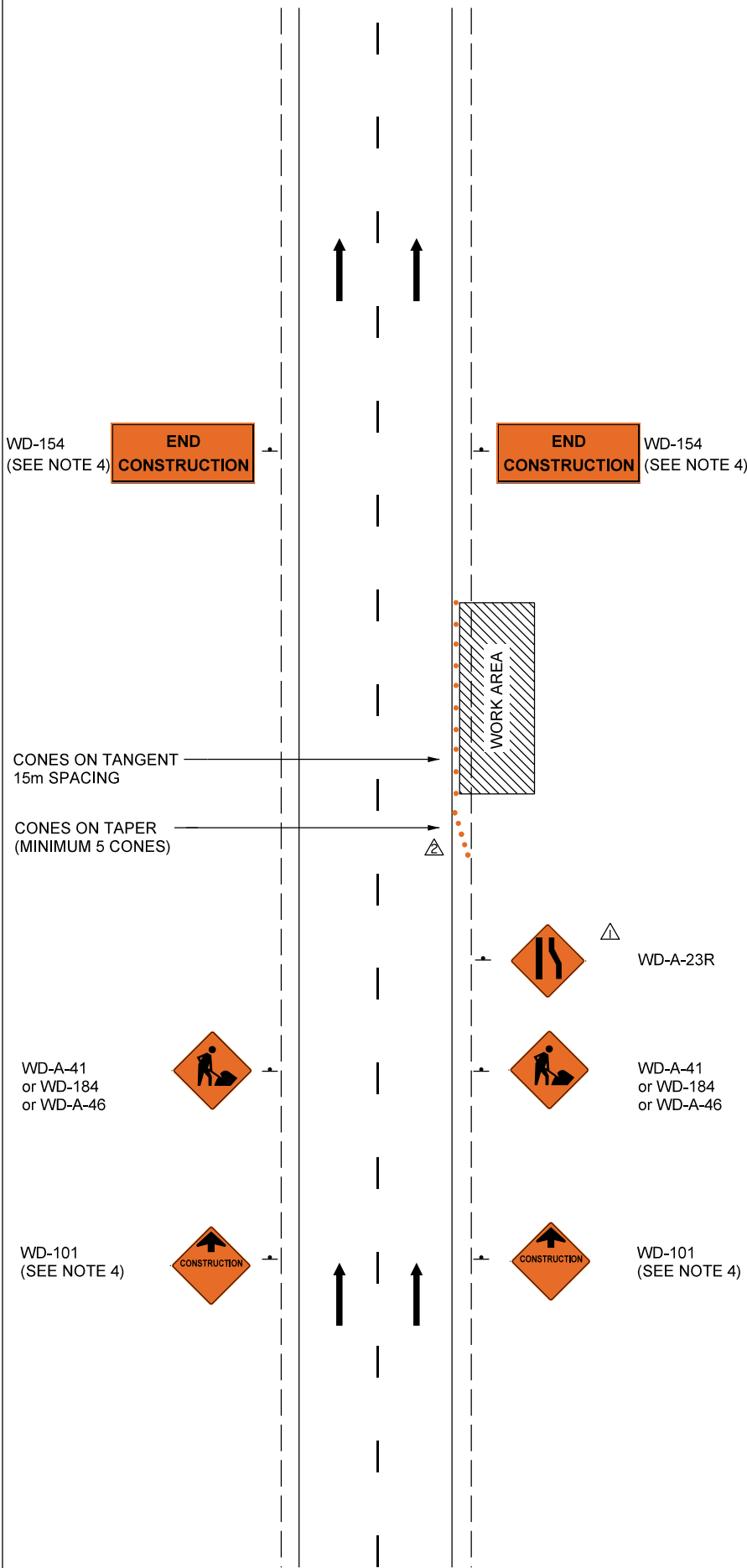

**NOTES:**

1. Consideration must be given to traffic volume, sight distances, sign spacing, duration of work, night time conditions and other factors to ensure traffic control devices are adequate in each instance.
2. All sign spacing shall be 25m-100m unless otherwise indicated.
3. For mobile operation, cones may not be required.
4. WD-101 and WD-154 signs not required for short duration work.
5. RB-5 and RB-1 signs will be used when a reduced speed zone is required. In this case gazetted speed to be posted after the work area.



RB-5



RB-1

6. If construction operation is occurring on the opposite travel lane, then applicable construction signing will also be required on those lanes.
7. Other hazard signs as shown in the schedule of signs may be used as required.

8.



WD-184



WD-A-46

	Cone points added.	EY	Nov 30/18
	Title Block updated and sign added.	JM	Dec 31/07
No.	REVISIONS	BY	DATE

Approved:

ORIGINAL SIGNED  
BY ALLAN KWAN

Executive Director,  
Technical Standards Branch

Date: MARCH, 2003

LOW SPEED / LOW VOLUME  
SIGNING FOR URBAN AREAS  
WORK ON SHOULDER  
FOUR LANE DIVIDED HIGHWAY

Prepared By: M.E.T.	Checked By: J.M.	Scale: N.T.S.	Dwg No.: TCS-B-7.3B
---------------------	------------------	---------------	---------------------

NOTES:

1. Consideration must be given to traffic volume, sight distances, sign spacing, duration of work, night time conditions and other factors to ensure traffic control devices are adequate in each instance.
2. All sign spacing shall be 25m-100m unless otherwise indicated.
3. Delineators/Cones shall be placed at 15m spacing. If the drop-off has a slope flatter than 3:1, cones are not required.
4. Light-duty barricades, WD-116-4L may be used instead of WD-116-1L and WD-116-4R may be used instead of WD-116-1R, when space is limited or where curbs/gutters are present.

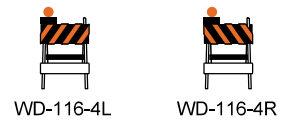

CONES ON TANGENT  
15m SPACING

CONES ON TAPER  
(MINIMUM 5 CONES)

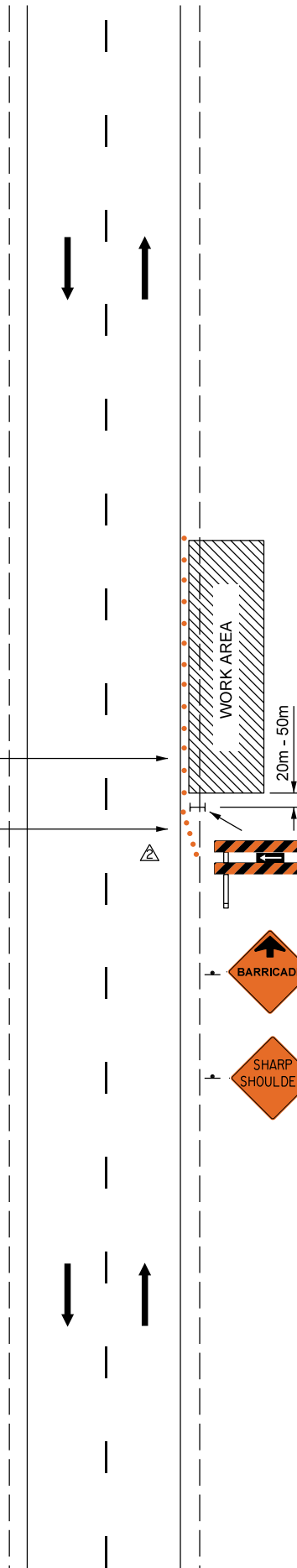

△ WD-116-1L  
(SEE NOTE 5)

△ WD-104  
BARRICADE

△ WD-A-100  
SHARP SHOULDER

△			
△	Cone points added and sign updated.	EY	Nov 30/18
△	Title Block updated, note and flasher eliminated.	JM	Dec 31/07
No.	REVISIONS	BY	DATE

Approved:

ORIGINAL SIGNED  
BY ALLAN KWAN

Executive Director,  
Technical Standards Branch

Date: MARCH, 2003

LOW SPEED / LOW VOLUME △  
SIGNING FOR URBAN AREAS  
SHOULDER DROP-OFF (WITHIN WORK ZONE)  
TWO LANE UNDIVIDED HIGHWAY

Prepared By: M.E.T.	Checked By: J.M.	Scale: N.T.S.	Dwg No.: TCS-B-7.4A
---------------------	------------------	---------------	---------------------

NOTES:

1. Consideration must be given to traffic volume, sight distances, sign spacing, duration of work, night time conditions and other factors to ensure traffic control devices are adequate in each instance.
2. All sign spacing shall be 25m-100m unless otherwise indicated.
3. Delineators/Cones shall be placed at 15m spacing. If the drop-off has a slope flatter than 3:1, cones are not required.
4. Light-duty barricades, WD-116-4L may be used instead of WD-116-1L and WD-116-4R may be used instead of WD-116-1R, when space is limited or where curbs/gutters are present.

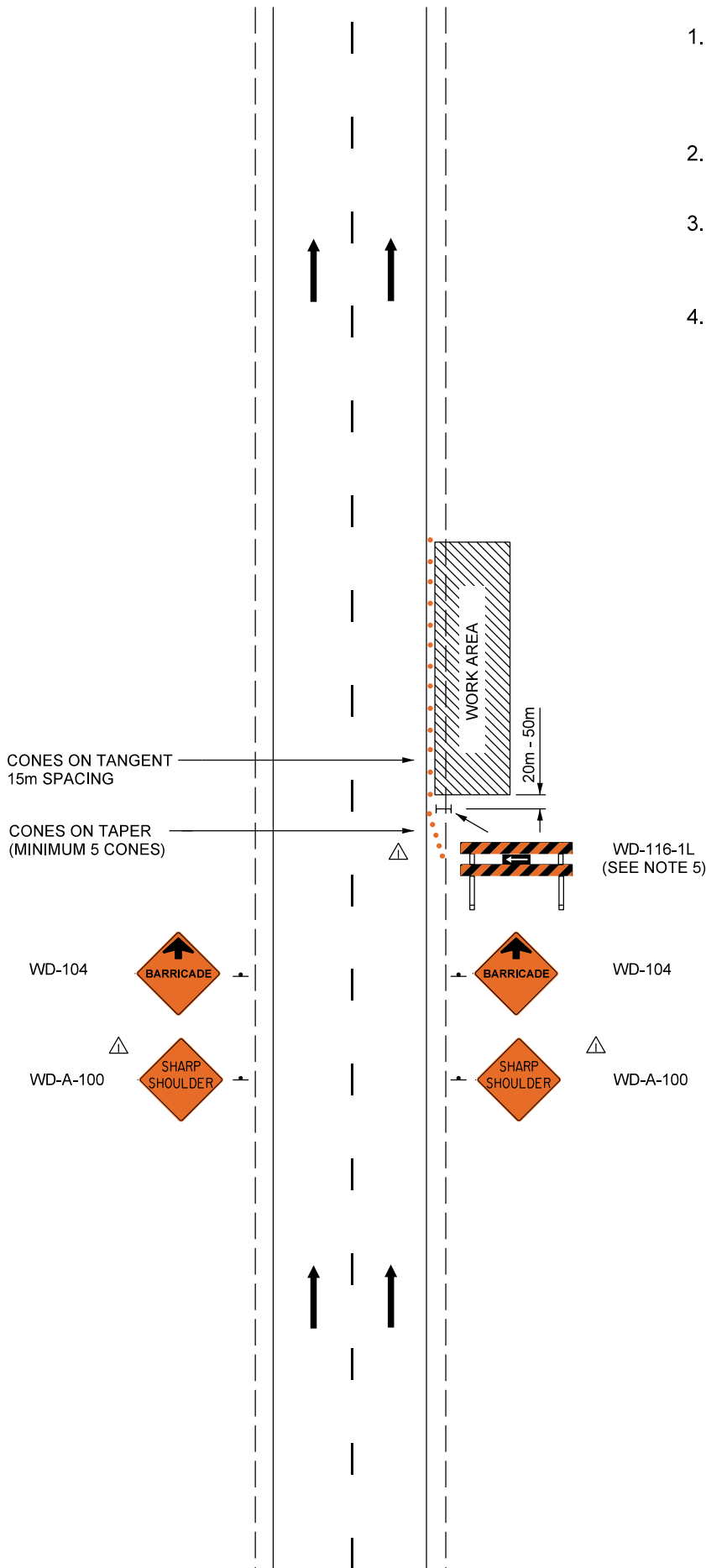

△			
△			
△	Cone points added and sign updated.	EY	Nov 30/18
No.	REVISIONS	BY	DATE

Approved:	
ORIGINAL SIGNED BY ALLAN KWAN  Executive Director, Technical Standards Branch	
Date: MARCH, 2003	

LOW SPEED / LOW VOLUME  
SIGNING FOR URBAN AREAS  
SHOULDER DROP-OFF (WITHIN WORK ZONE)  
FOUR LANE DIVIDED HIGHWAY

Prepared By: M.E.T.	Checked By: J.M.	Scale: N.T.S.	Dwg No.: TCS-B-7.4B
---------------------	------------------	---------------	---------------------



NOTES:

1. Consideration must be given to traffic volume, sight distances, sign spacing, duration of work, night time conditions and other factors to ensure traffic control devices are adequate in each instance.
2. All sign spacing shall be 25m-100m unless otherwise indicated.
3. RB-1 sign will be required where a reduced speed zone is in place.
4. WD-101 may be replaced by WD-A-41 for short duration work.

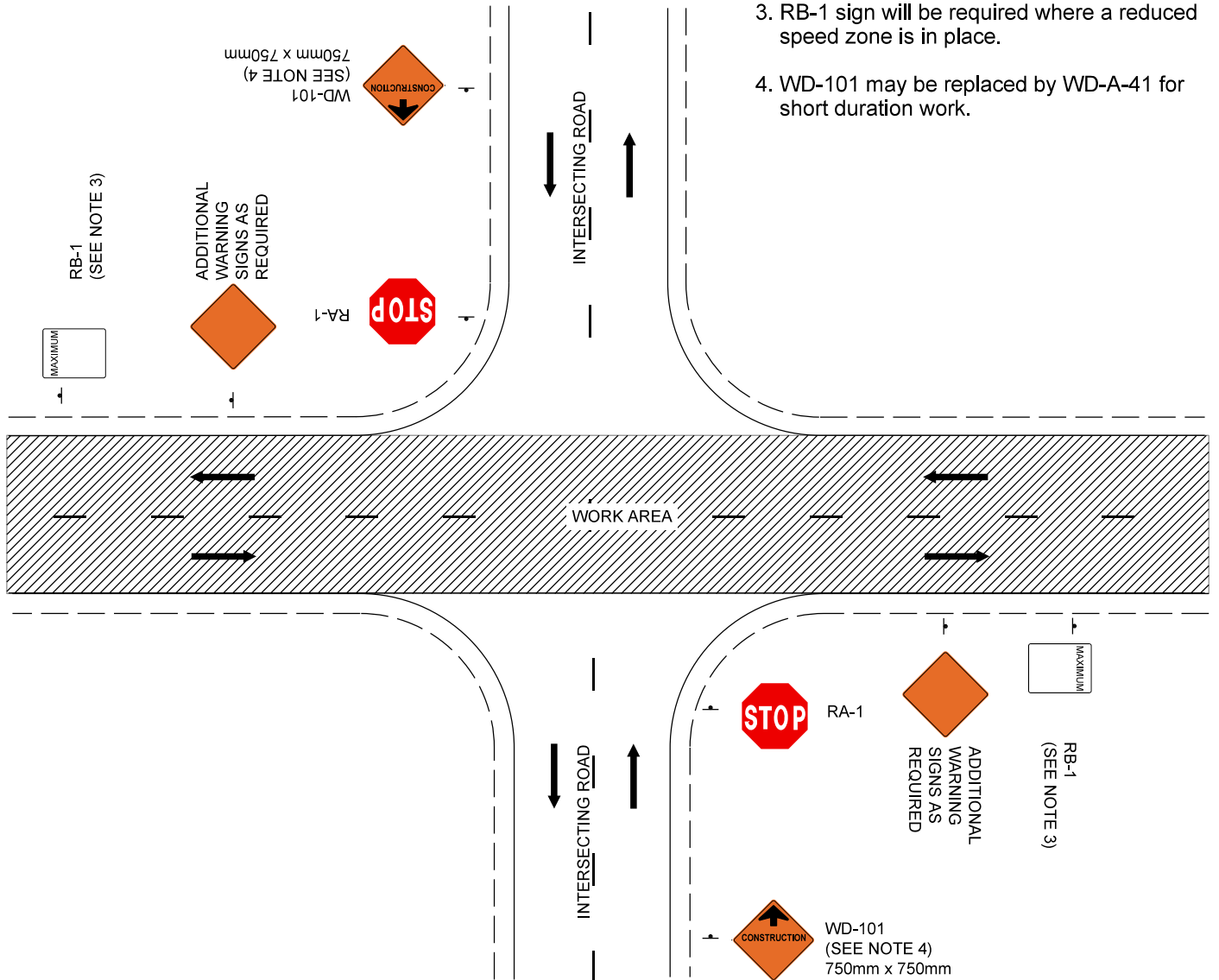

△			
△			
△	Title Block and notes updated.	JM	Dec 31/07
No.	REVISIONS	BY	DATE

Approved:

ORIGINAL SIGNED  
BY ALLAN KWAN

Executive Director,  
Technical Standards Branch

Date: MARCH, 2003



LOW SPEED / LOW VOLUME -  
SIGNING FOR URBAN AREAS  
INTERSECTING ROADS  
TWO LANE UNDIVIDED HIGHWAY

Prepared By: M.E.T.	Checked By: J.M.	Scale: N.T.S.	Dwg No.: TCS-B-7.5A
---------------------	------------------	---------------	---------------------

NOTES:

1. Consideration must be given to traffic volume, sight distances, sign spacing, duration of work, night time conditions and other factors to ensure traffic control devices are adequate in each instance.
2. All sign spacing shall be 25m-100m unless otherwise indicated.
3. RB-1 sign will be required where a reduced speed zone is in place.
4. WD-101 may be replaced by WD-A-41 for short duration work.

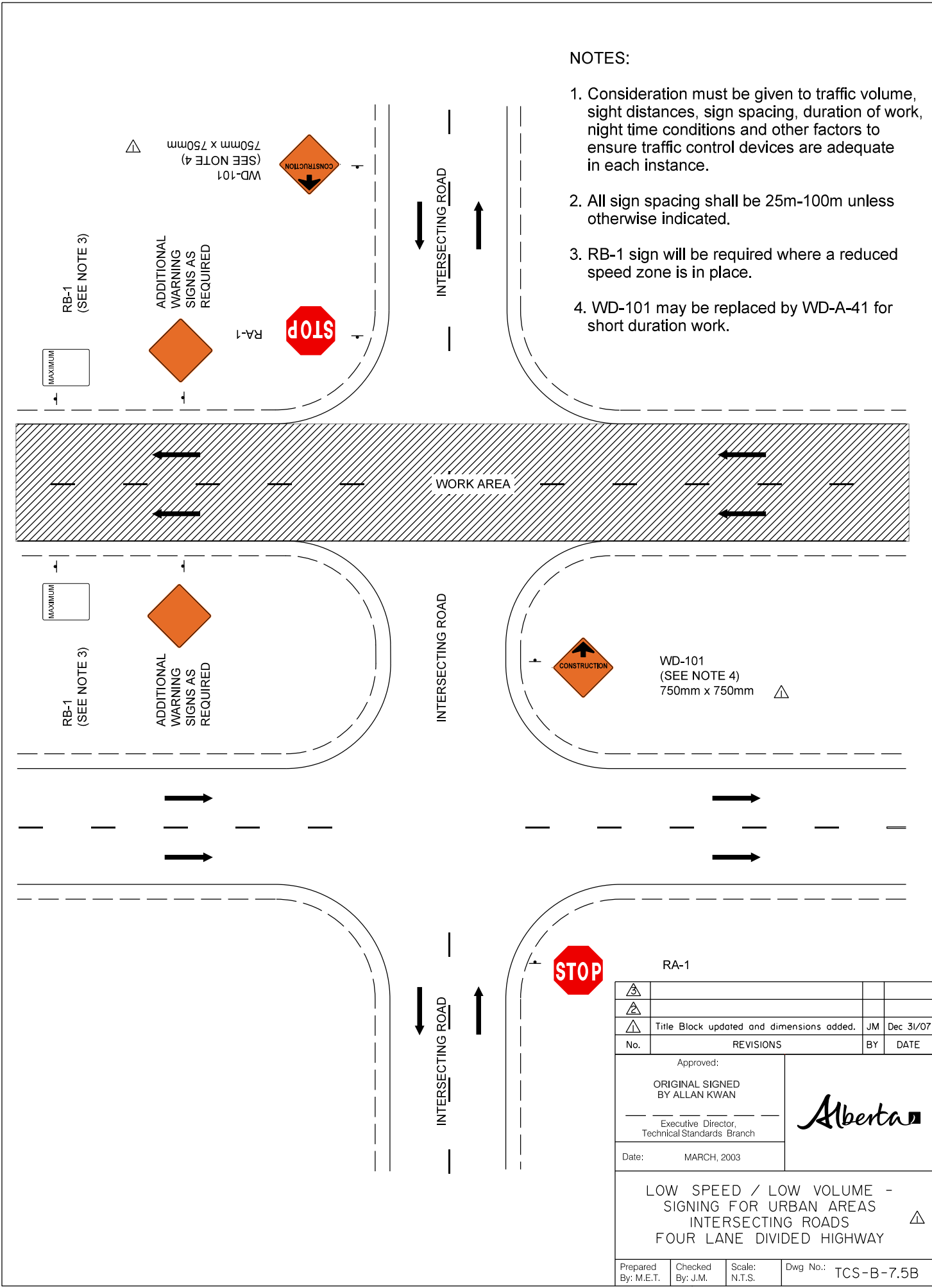

△			
△			
△	Title Block updated and dimensions added.	JM	Dec 31/07
No.	REVISIONS	BY	DATE

Approved:  
 ORIGINAL SIGNED  
 BY ALLAN KWAN  
 Executive Director,  
 Technical Standards Branch  
 Date: MARCH, 2003



LOW SPEED / LOW VOLUME -  
 SIGNING FOR URBAN AREAS  
 INTERSECTING ROADS  
 FOUR LANE DIVIDED HIGHWAY

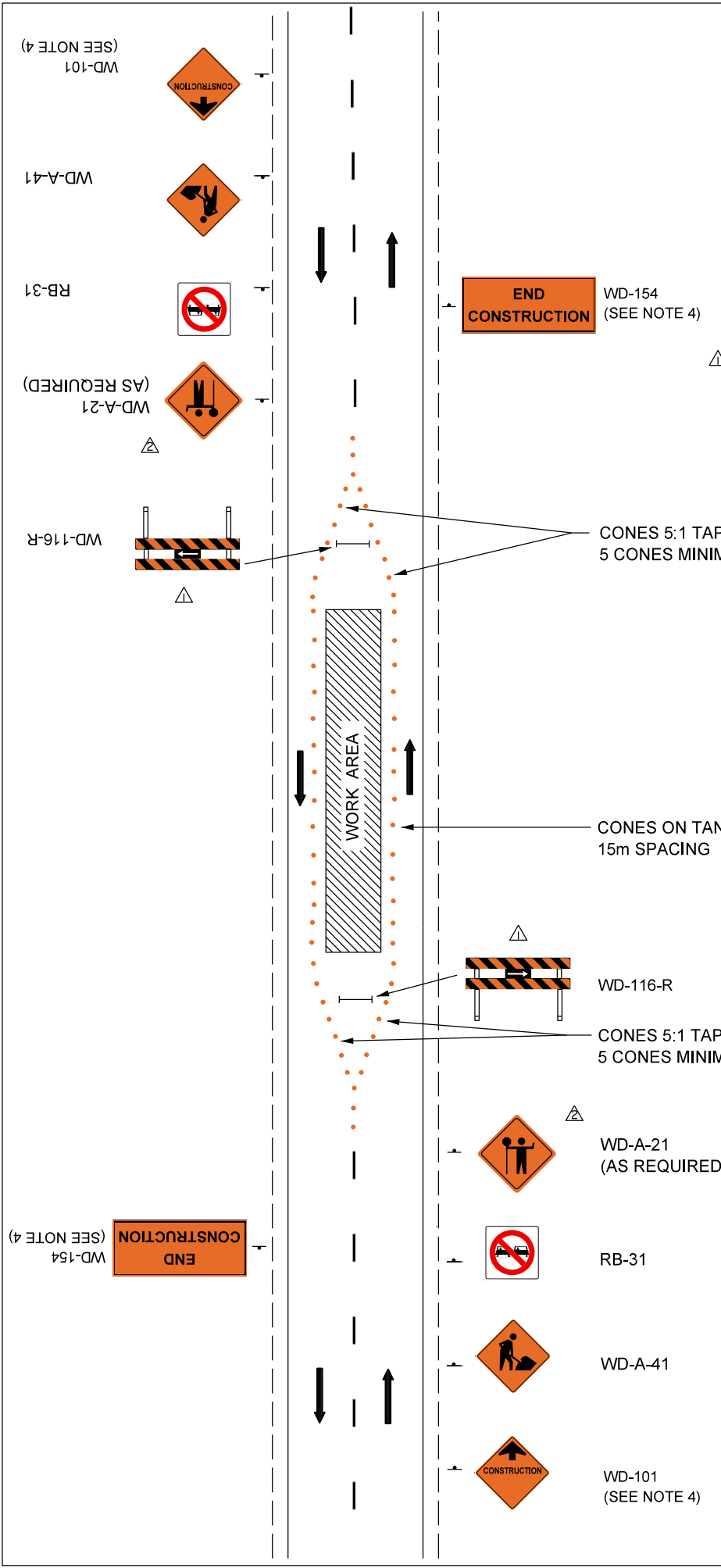

**NOTES:**

1. Consideration must be given to traffic volume, sight distances, sign spacing, duration of work, night time conditions and other factors to ensure traffic control devices are adequate in each instance.
2. All sign spacing shall be 25m-100m unless otherwise indicated.
3. Minimum lane width of 3.5m is required
4. WD-101 and WD-154 signs not required for short duration work.
5. RB-5 and RB-1 signs will be used when a reduced speed zone is required. In this case gazetted speed to be posted after the work area.





6. RB-31 may not be required when existing solid barrier yellow line is in place.

△			
△	Signs updated.	EY	Nov 30/18
△	Title Block updated, flashers and note eliminated.	JM	Dec 31/07
No.	REVISIONS	BY	DATE
Approved:			
ORIGINAL SIGNED BY ALLAN KWAN			
Executive Director, Technical Standards Branch			
Date:	MARCH, 2003		
LOW SPEED / LOW VOLUME - SIGNING FOR URBAN AREAS WORK ON CENTRELINE TWO LANE TRAFFIC TWO LANE UNDIVIDED HIGHWAY			
Prepared By: M.E.T.	Checked By: J.M.	Scale: N.T.S.	Dwg No.: TCS-B-7.6A

NOTES:

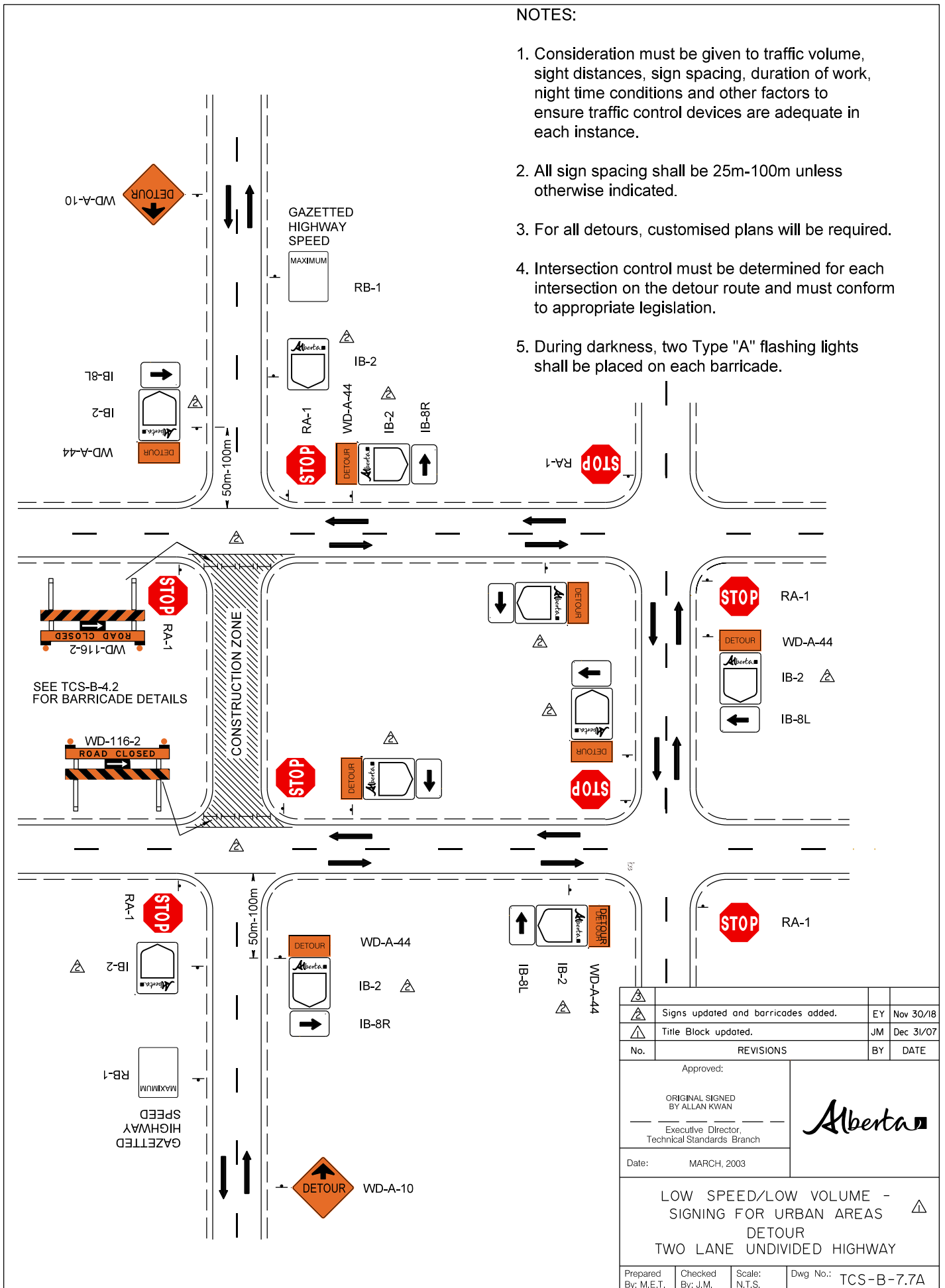
1. Consideration must be given to traffic volume, sight distances, sign spacing, duration of work, night time conditions and other factors to ensure traffic control devices are adequate in each instance.
2. All sign spacing shall be 25m-100m unless otherwise indicated.
3. For all detours, customised plans will be required.
4. Intersection control must be determined for each intersection on the detour route and must conform to appropriate legislation.
5. During darkness, two Type "A" flashing lights shall be placed on each barricade.



▲			
▲	Signs updated and barricades added.	EY	Nov 30/18
▲	Title Block updated.	JM	Dec 31/07
No.	REVISIONS	BY	DATE
Approved:			
ORIGINAL SIGNED BY ALLAN KWAN			
Executive Director, Technical Standards Branch			
Date:	MARCH, 2003		
LOW SPEED/LOW VOLUME - SIGNING FOR URBAN AREAS DETOUR TWO LANE UNDIVIDED HIGHWAY			
Prepared By: M.E.T.	Checked By: J.M.	Scale: N.T.S.	Dwg No.: TCS-B-7.7A

△ NOTES:

1. Consideration must be given to traffic volume, sight distances, sign spacing, duration of work, night time conditions and other factors to ensure traffic control devices are adequate in each instance.
2. All sign spacing shall be 25m-100m unless otherwise indicated.

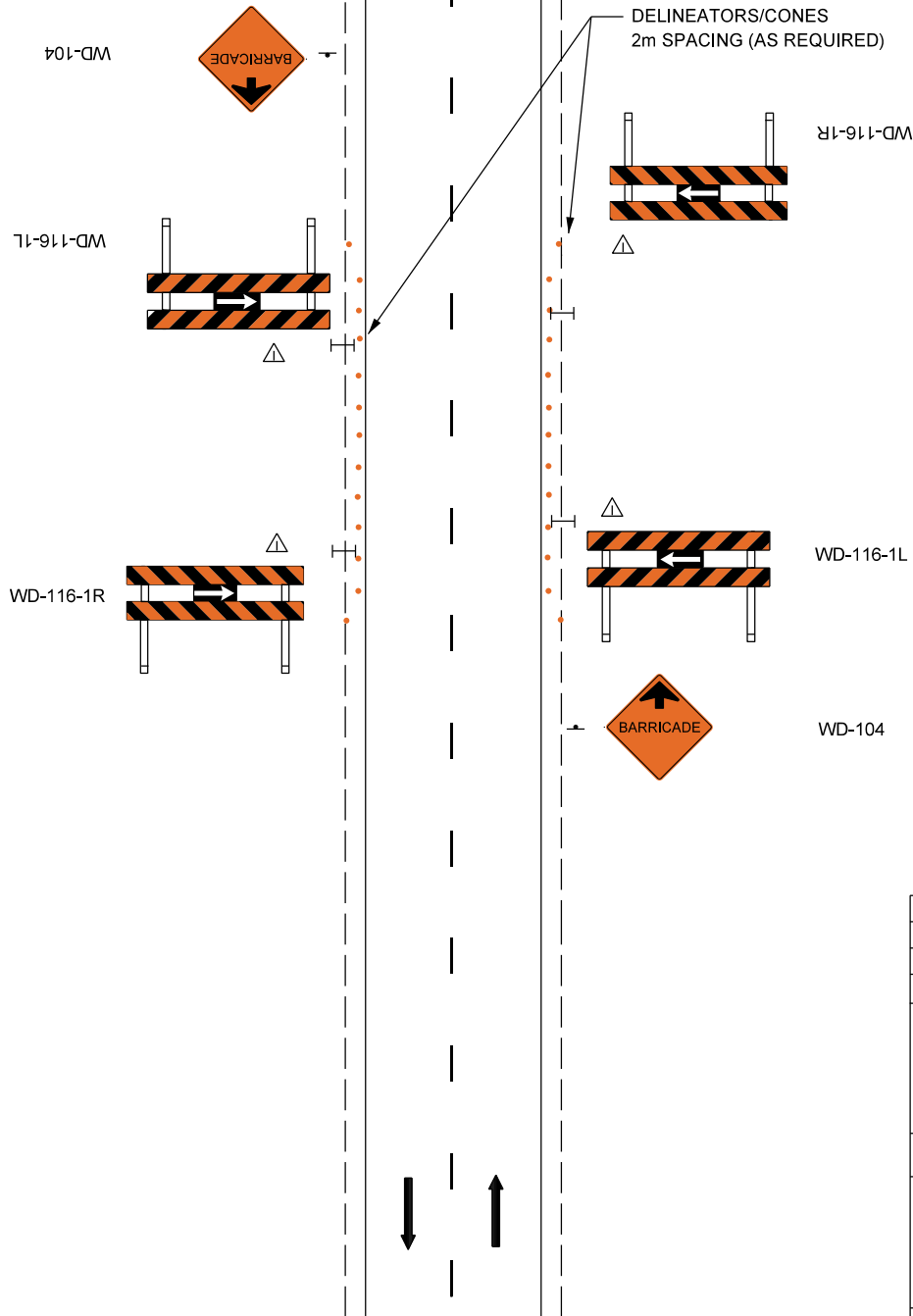

△			
△			
△	Title block updated and flashers, note eliminated.	JM	Dec 31/07
No.	REVISIONS	BY	DATE
Approved:			
ORIGINAL SIGNED BY ALLAN KWAN			
Executive Director, Technical Standards Branch			
Date:	MARCH, 2003		
LOW SPEED/LOW VOLUME - SIGNING FOR URBAN AREAS EMBANKMENT AND FIXED OBJECTS TWO LANE UNDIVIDED HIGHWAY			
Prepared By: M.E.T.	Checked By: J.M.	Scale: N.T.S.	Dwg No.: TCS-B-7.8A

△ NOTES:

1. Consideration must be given to traffic volume, sight distances, sign spacing, duration of work, night time conditions and other factors to ensure traffic control devices are adequate in each instance.
2. All sign spacing shall be 25m-100m unless otherwise indicated.

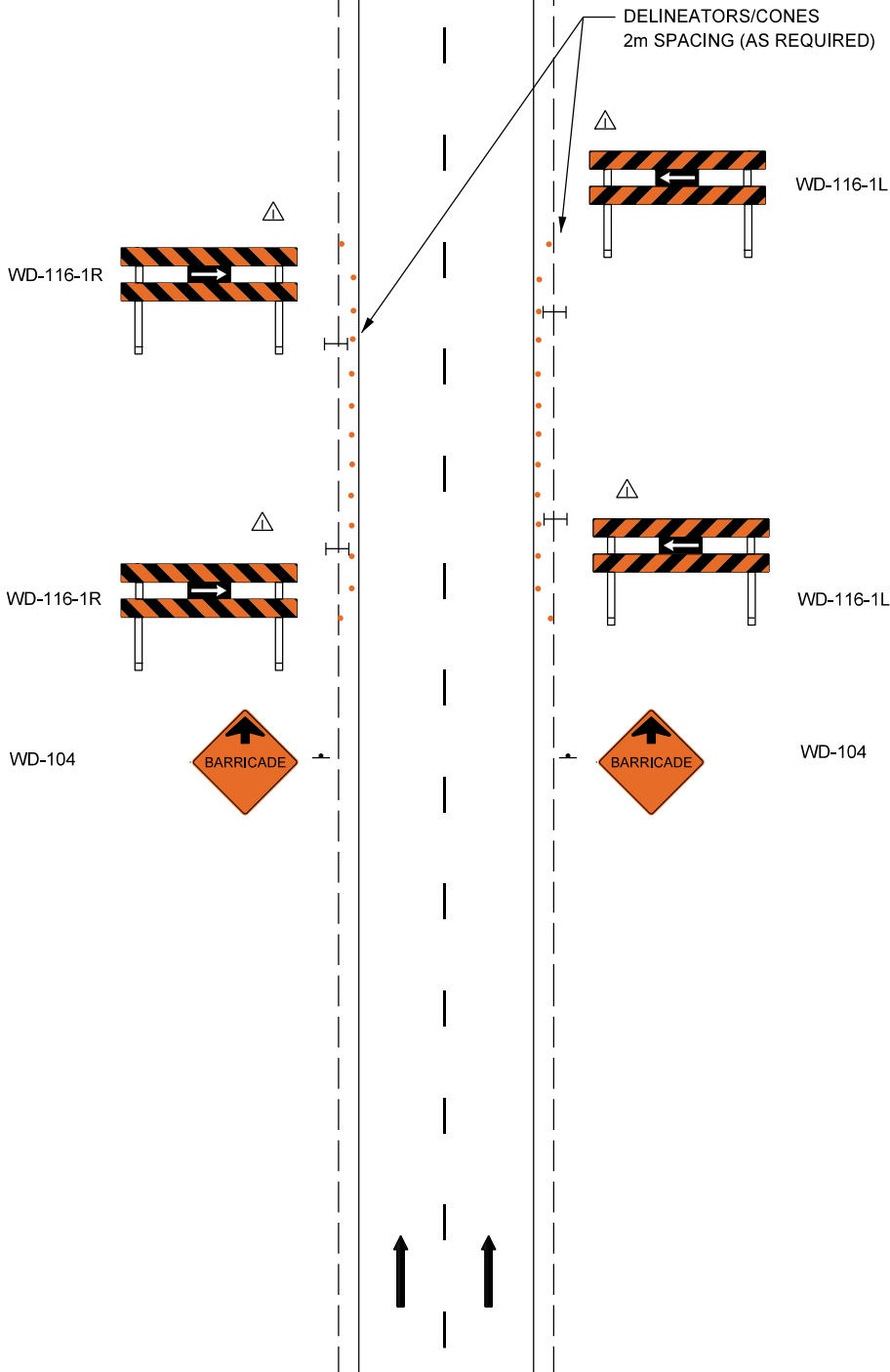

△			
△			
△	Title block updated and flashers, note eliminated.	JM	Dec 31/07
No.	REVISIONS	BY	DATE
Approved:			
ORIGINAL SIGNED BY ALLAN KWAN			
Executive Director, Technical Standards Branch			
Date:	MARCH, 2003		
LOW SPEED/LOW VOLUME - △ SIGNING FOR URBAN AREAS EMBANKMENT AND FIXED OBJECTS FOUR LANE DIVIDED HIGHWAY			
Prepared By: M.E.T.	Checked By: J.M.	Scale: N.T.S.	Dwg No.: TCS-B-7.8B

NOTE: DETAILS OF WARNING/REGULATORY SIGNS SAME AS THOSE ON OTHER SIDE OF HIGHWAY

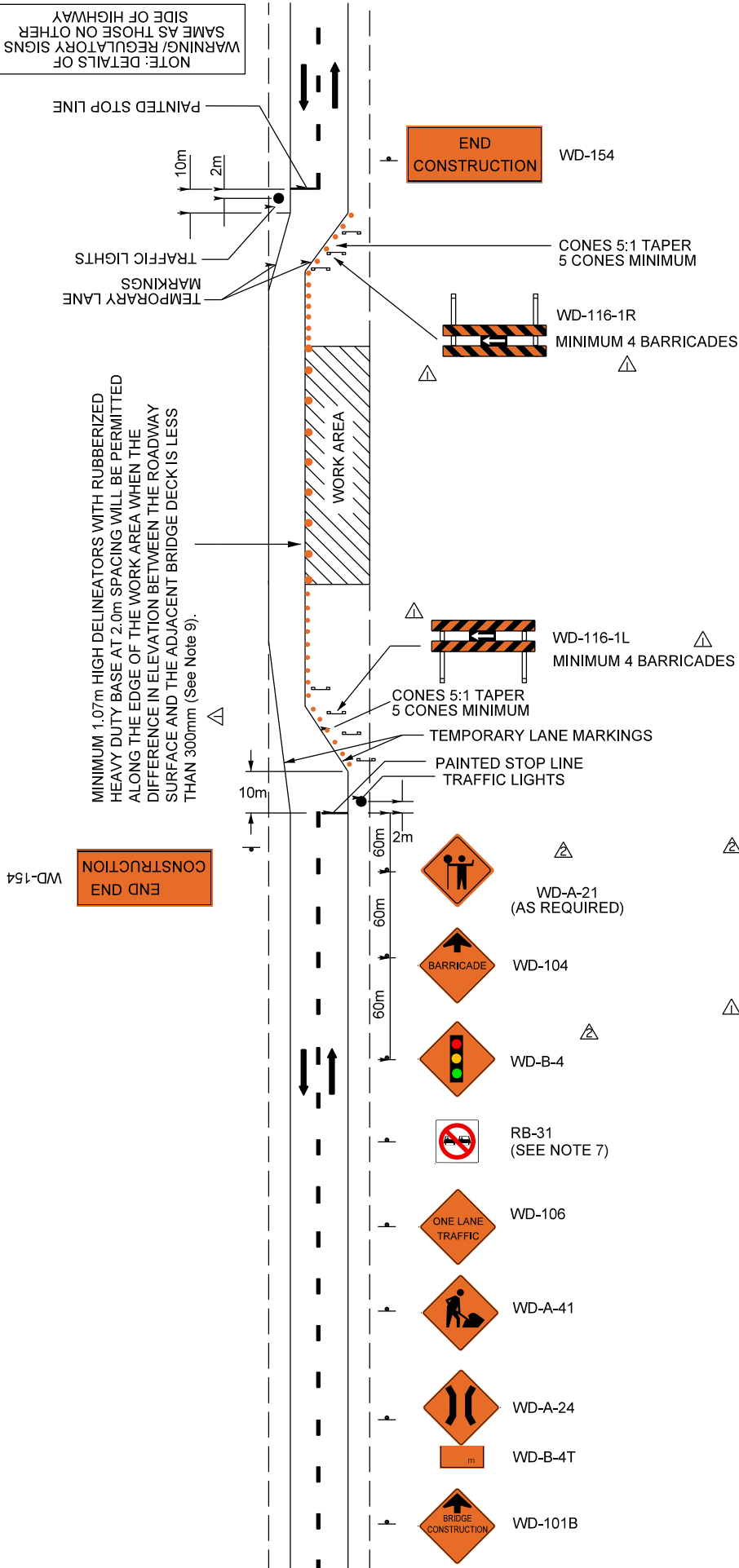

**NOTES:**

1. Consideration must be given to traffic volume, sight distances, sign spacing, duration of work, night time conditions and other factors to ensure traffic control devices are adequate in each instance.
2. When switching traffic during staged construction, a specialized traffic accommodation plan is required.
3. All sign spacing shall be 25m-100m unless otherwise indicated
4. Traffic lights shall be 300mm diameter.
5. A minimum lane width of 3.5m is required.
6. RB-31 sign not required when existing solid yellow barrier line is in place.
7. RB-5 and RB-1 signs will be used when a reduced speed zone is required. In this case gazetted speed to be posted after the work area.



8. WD-194 sign, together with RA-2 sign, may be used instead of WD-A-21/traffic light if sight distance is adequate.



RA-2

WD-194

9. If the drop off is greater than 300mm use drawing TCS-B-1.27A (Long Duration).

	Note and signs updated.	EY	Nov 30/18
	Title block and notes updated, note added and flasher eliminated.	JM	Dec 31/07
No.	REVISIONS	BY	DATE
Approved:			
ORIGINAL SIGNED BY ALLAN KWAN			
Executive Director, Technical Standards Branch			
Date:	MARCH, 2003		
LOW SPEED/LOW VOLUME - SIGNING FOR URBAN AREAS TYPICAL EXCAVATION SIGNING FOR URBAN AREAS (ONE LANE ALTERNATING TRAFFIC) TWO LANE UNDIVIDED HIGHWAY			
Prepared By: M.E.T.	Checked By: J.M.	Scale: N.T.S.	Dwg No.: TCS-B-7.9A

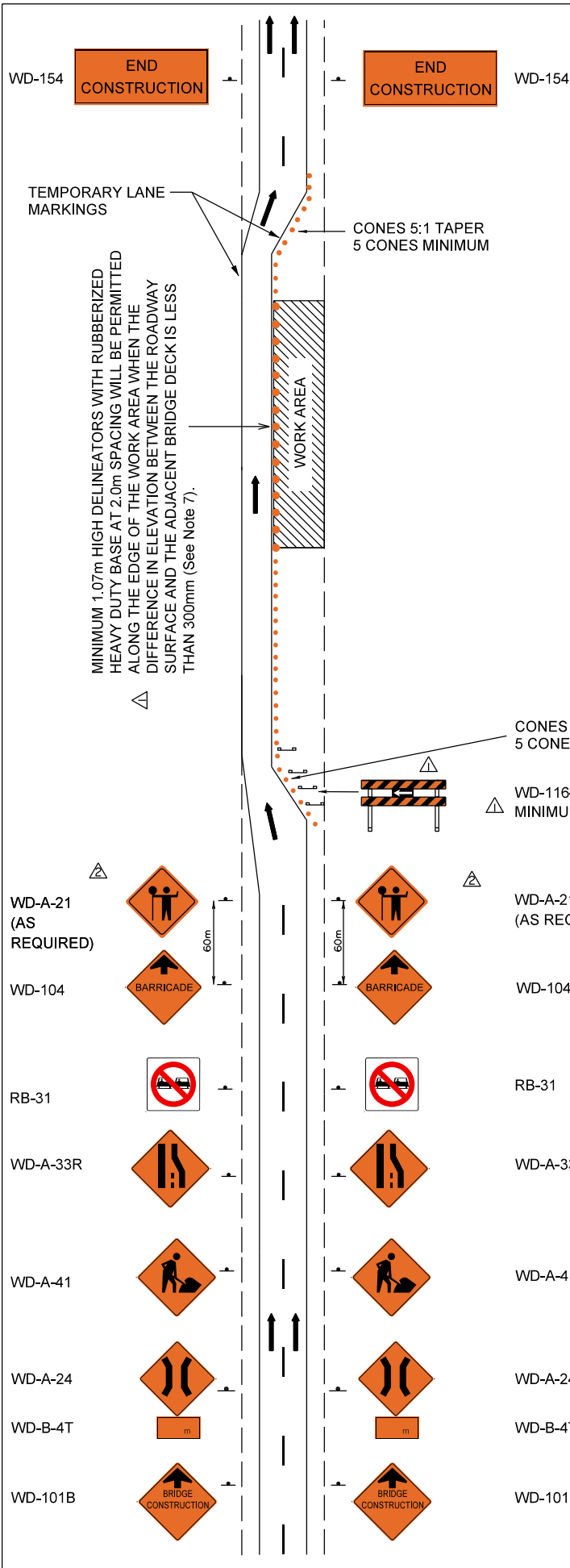

**NOTES:**

1. Consideration must be given to traffic volume, sight distances, sign spacing, duration of work, night time conditions and other factors to ensure traffic control devices are adequate in each instance.
2. When switching traffic during staged construction, a specialized traffic accommodation plan is required.
3. All sign spacing shall be 25m - 100m unless otherwise indicated.
4. A minimum lane width of 3.5m is required.
5. Conflicting lane markings shall be removed.
6. RB-5 and RB-1 signs will be used when a reduced speed zone is required. In this case gazetted speed to be posted after the work area.



RB-5



RB-1



7. If the drop off is greater that 300mm use drawing TCS-B-1.21B (Long Duration)

	Signs updated.	EY	Nov 30/18
	Title block and notes updated, note added and flasher eliminated.	JM	Dec 31/07
No.	REVISIONS	BY	DATE
Approved:			
ORIGINAL SIGNED BY ALLAN KWAN			
Executive Director, Technical Standards Branch			
Date:	MARCH, 2003		
LOW SPEED/LOW VOLUME - SIGNING FOR URBAN AREAS TYPICAL EXCAVATION SIGNING FOR URBAN AREAS ONE-LANE CLOSURE FOUR LANE DIVIDED HIGHWAY			
Prepared By: M.E.T.	Checked By: J.M.	Scale: N.T.S.	Dwg No.: TCS-B-7.9B



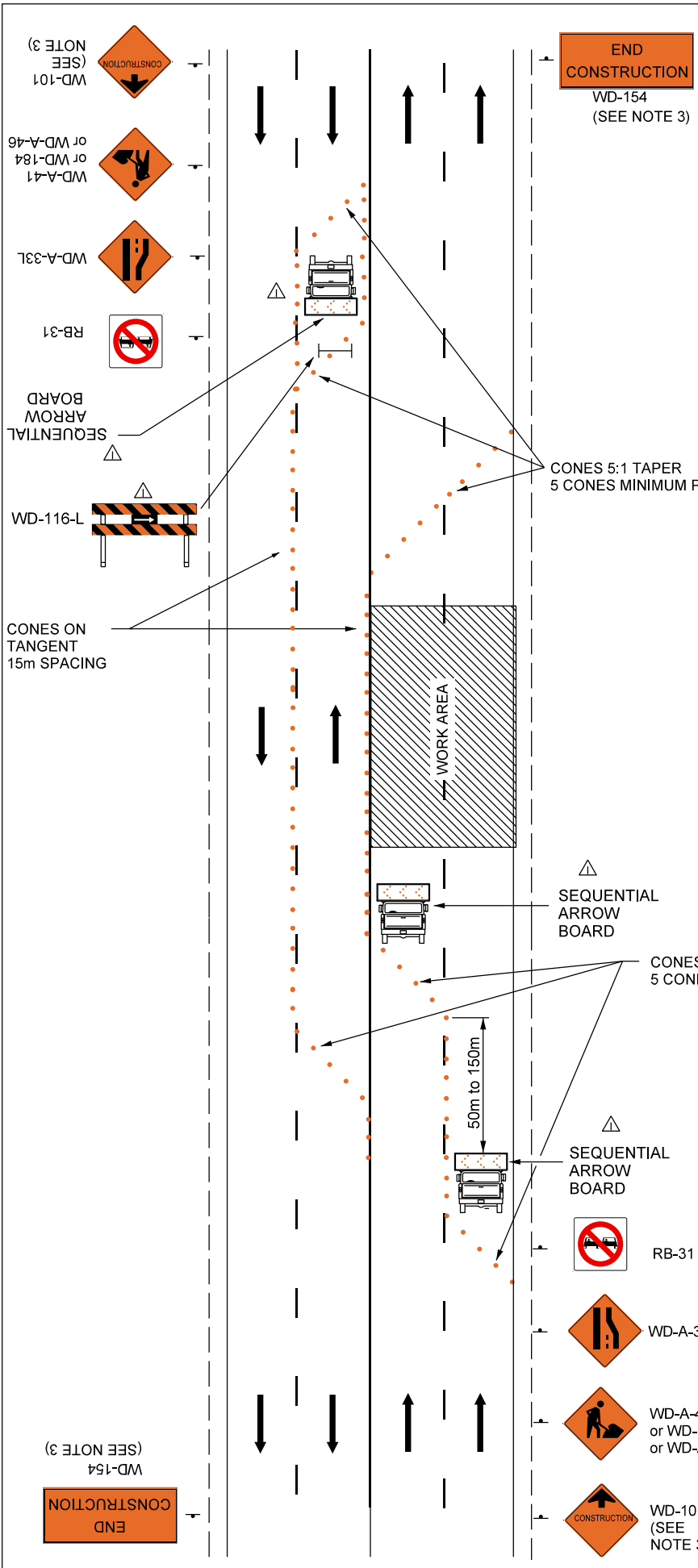



**NOTES:**

1. Consideration must be given to traffic volume, sight distances, sign spacing, duration of work, night time conditions and other factors to ensure traffic control devices are adequate in each instance.
2. All sign spacing shall be 25m-100m unless otherwise indicated.
3. WD-101 and WD-154 sign not required for short duration work.
4. RB-5 and RB-1 signs will be used where a reduced speed zone is required. In this case gazetted speed to be posted after the work area.
5. Other hazard signs as shown in the schedule of signs may be used as required.
6. The Sequential arrow board shall be located in the centre of the closed lane.
7.
 

  
 WD-184

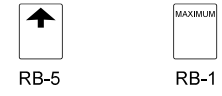
  
 WD-A-46



△			
△			
△	Title block and notes updated, flashers and barriers eliminated, Sequential arrow board and cones added.	JM	Dec 31/07
No.	REVISIONS	BY	DATE
Approved:			
ORIGINAL SIGNED BY ALLAN KWAN			
Executive Director, Technical Standards Branch			
Date:	MARCH, 2003		
LOW SPEED/LOW VOLUME - SIGNING FOR URBAN AREAS △ TWO-LANE CLOSURE WITH 2-WAY TRAFFIC FOUR LANE UNDIVIDED HIGHWAY			
Prepared By: M.E.T.	Checked By: J.M.	Scale: N.T.S.	Dwg No.: TCS-B-7.10B

# TRAFFIC ACCOMMODATION IN WORK ZONES

## LIST OF DRAWINGS

Click the links below to get to the drawings. To go back to the Drawings by Category Table of Contents: click [here](#)

STANDARD DRAWINGS FOR TRAFFIC CONTROL DEVICES			
TCS-B Drawing No.	2 Lane Undivided	4 Lane Divided	Description
<a href="#">4.1</a>			<a href="#">Standard Barricade</a>
<a href="#">4.2</a>			<a href="#">Traffic Control Paddle</a>
<a href="#">4.3</a>			<a href="#">Traffic Barrel/Drum</a>

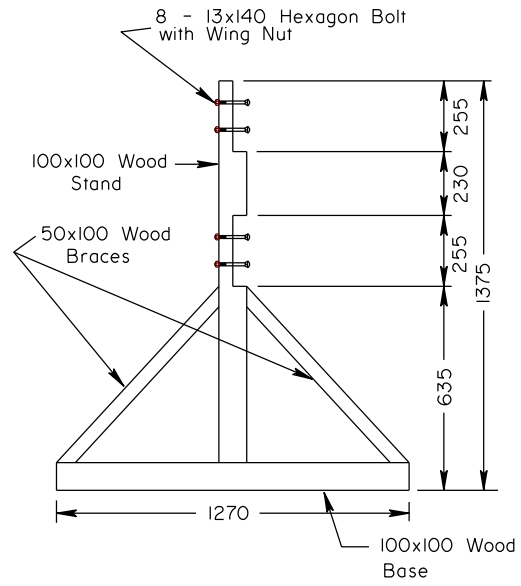
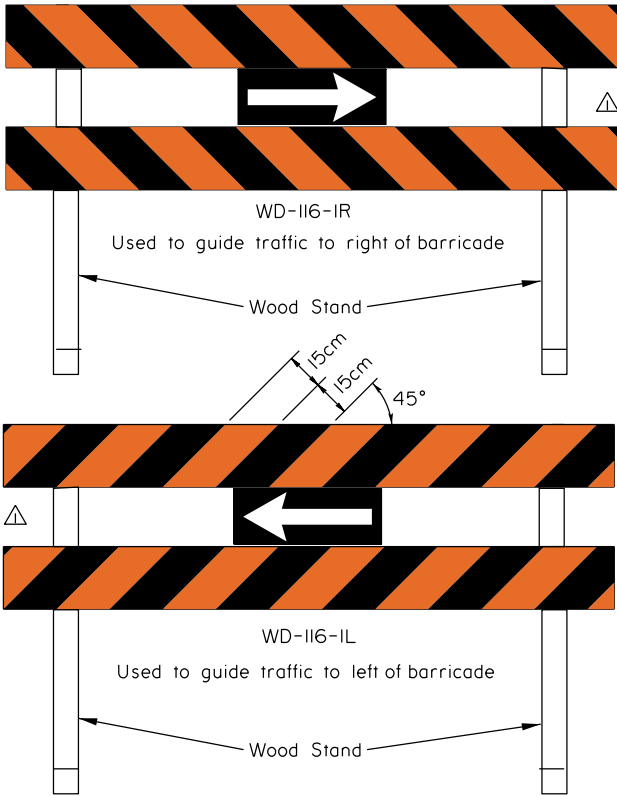

**BRIDGE OUT**

WD-116-3

244cm

**ROAD CLOSED**

25cm

WD-116-2

Bridge Out and Road Closed boards may be used to replace one diagonal stripe board where appropriate. All dimensions are in millimetres unless otherwise indicated.

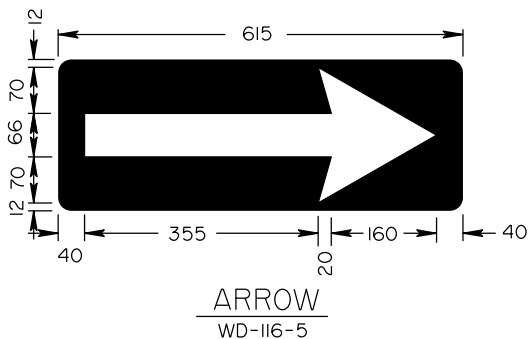

Note: Arrow Sign may be installed on the wood stand on the traffic side.

	Note and Title Block updated.	JM	Dec 31/07
No.	REVISIONS	BY	DATE
Approved: Original signed by Tim Hawnt Executive Director, Technical Standards Branch			
Date:	MARCH, 2001		
MISCELLANEOUS ITEMS - STANDARD BARRICADE USED FOR CONSTRUCTION PROJECTS			
Prepared By: G.E.C.	Checked By: P.H.	Scale: N.T.S.	Dwg No.: TCS-B-4,1

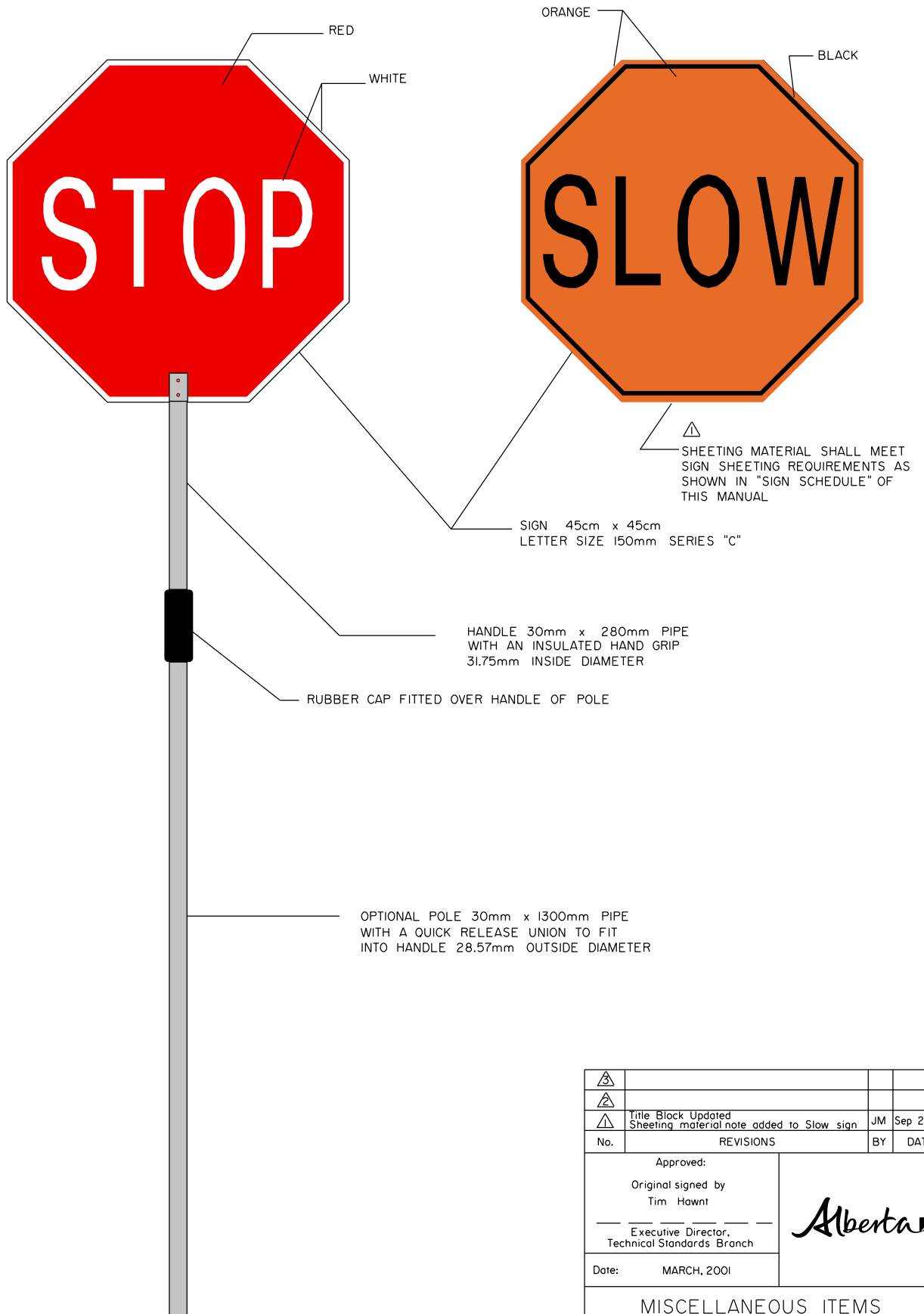

△			
△			
△	Title Block Updated Sheeting material note added to Slow sign	JM	Sep 23/08
No.	REVISIONS	BY	DATE
Approved:			
Original signed by Tim Hawnt			
Executive Director, Technical Standards Branch			
Date:	MARCH, 2001		
MISCELLANEOUS ITEMS △ TRAFFIC CONTROL PADDLE			
Prepared By: M.T.	Checked By: P.H.	Scale: N.T.S.	Dwg No.: TCS-B-4.2

WHITE REFLECTIVE BAND MATERIAL SHALL MEET SIGN SHEETING REQUIREMENTS AS PER SECTION 7.1.4.1 "MATERIALS" OF THE LATEST VERSION OF ALBERTA TRANSPORTATION STANDARD SPECIFICATIONS FOR HIGHWAY/BRIDGE CONSTRUCTION.

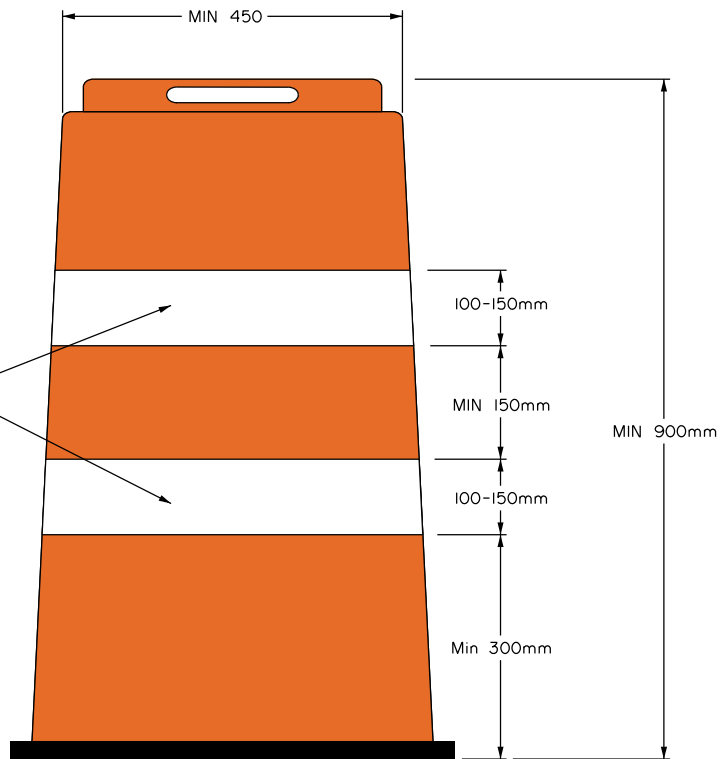

No.	REVISIONS	BY	DATE
Approved:			
Original signed by Allan Kwan			
Executive Director, Technical Standards Branch			
Date:	OCTOBER, 2008		
MISCELLANEOUS ITEMS - TRAFFIC BARREL/DRUM			
Prepared By: M.T.	Checked By: J.M.	Scale: N.T.S.	Dwg No.: TCS-B-4.3

## TRAFFIC ACCOMMODATION IN WORK ZONES

Click the links below to get to the drawings. To go back to the Drawings by Category Table of Contents: click [here](#)

WORK ZONE BULLETIN DRAWINGS			
TCS-B Drawing No.	2 Lane Undivided	4 Lane Divided	Description
<a href="#">TCS-B-4.4</a>	X		<a href="#">Typical Signing One Lane Closure with Speed Fines Double Signage Two Lane Undivided Highway</a>
<a href="#">TCS-B-4.5</a>		X	<a href="#">Typical Signing One Lane Closure Using Zipper Merge Signage Strategy Four Lane Divided Highway</a>
<a href="#">TCS-B-4.6A</a>	X		<a href="#">Typical Signing One Lane Closure (With Transition Speed Zone on Approach Only) Two Lane Undivided Highway</a>
<a href="#">TCS-B-4.6B</a>	X		<a href="#">Typical Signing One Lane Closure (With Transition Speed Zone on Approach and Exit) Two Lane Undivided Highway</a>
<a href="#">TCS-B-4.7A</a>	X		<a href="#">Typical Signing Portable Rumble Strips (In Advance of Flagperson or Other Stop Condition) Two Lane Undivided Highway</a>
<a href="#">TCS-B-4.7B</a>		X	<a href="#">Typical Signing Portable Rumble Strips (In Advance of Flagperson or Other Stop Condition) Four Lane Divided Highway</a>
<a href="#">TCS-B-4.7C</a>	X		<a href="#">Typical Signing Portable Rumble Strips (In Advance of Stop and Go Traffic Condition) Two Lane Undivided Highway</a>
<a href="#">TCS-B-4.7D</a>		X	<a href="#">Typical Signing Portable Rumble Strips (In Advance of Stop and Go Traffic Condition) Four Lane Divided Highway</a>
<a href="#">TCS-B-4.8A</a>			<a href="#">Gateway Assemblies</a>
<a href="#">TCS-B-4.8B</a>	X		<a href="#">Gateway Assemblies Rural Undivided Highway</a>
<a href="#">TCS-B-4.8C</a>		X	<a href="#">Gateway Assemblies Rural Divided Highway With Depressed Median</a>
<a href="#">TCS-B-4.8D</a>	X		<a href="#">Typical Signing One Lane Closure (With Gateway Assemblies) Two Lane Undivided Highway</a>
<a href="#">TCS-B-4.9</a>	X		<a href="#">Typical Signing One Lane Closure (With Workers Present When Flasing Signs) Two Lane Undivided Highway</a>

NOTES:

1. Consideration must be given to traffic volume, sight distances, sign spacing, duration of work, night time conditions and other factors to ensure traffic control devices are adequate in each instance.
2. Reduced speed limit for work area is to be established based on the traffic accommodation strategy guidelines.
3. WD-192, WD-101, WD-154 signs are not required for short duration work.
4. For mobile or short duration active work areas, the "Begins" / "Speed Fines Double" sign assembly can be mounted as a separate sign assembly in advance of the reduced RB-1 sign.

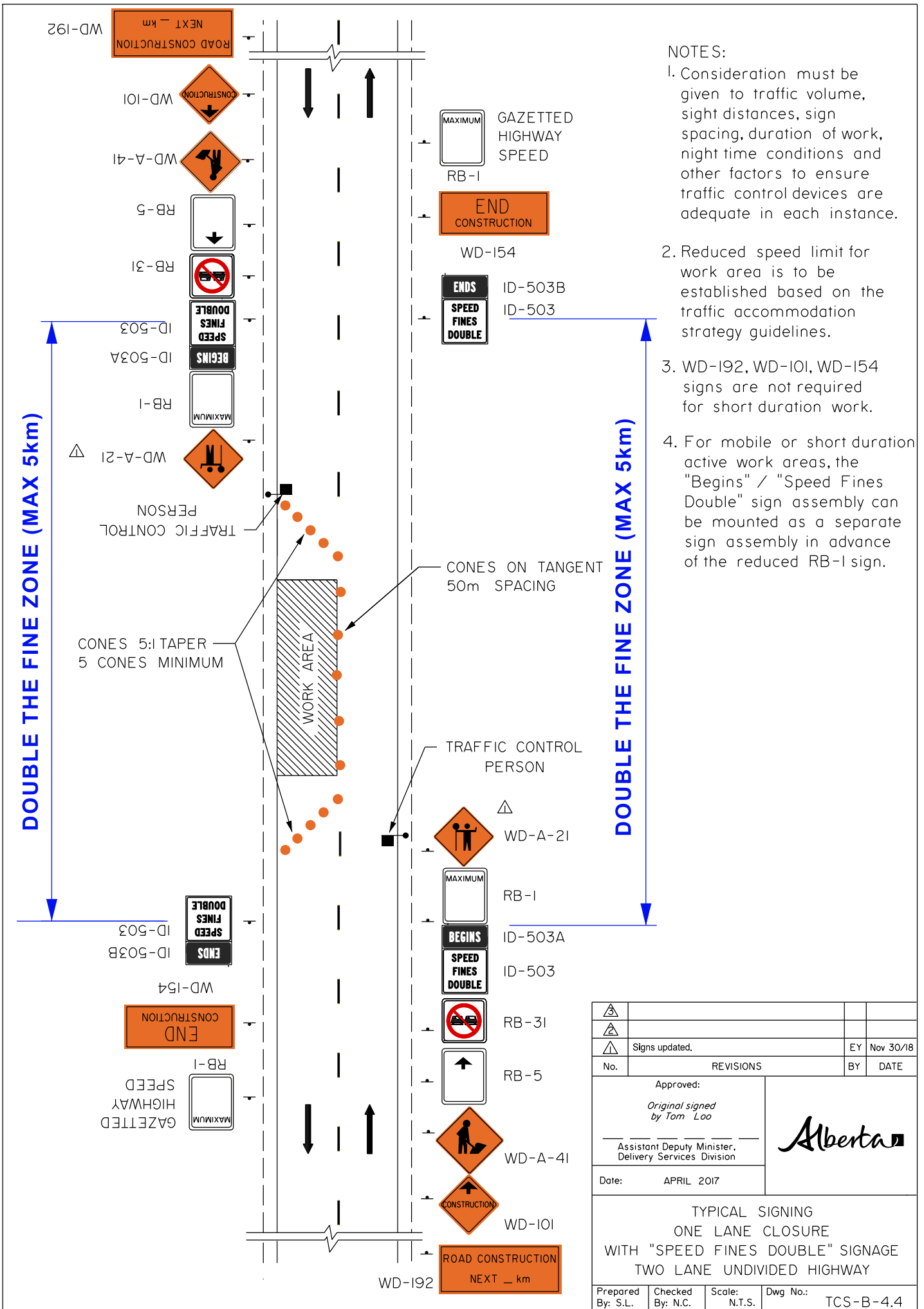

△			
△	Signs updated.	EY	Nov 30/18
No.	REVISIONS	BY	DATE

Approved:  
*Original signed by Tom Loo*  
 Assistant Deputy Minister,  
 Delivery Services Division

Date: APRIL 2017



TYPICAL SIGNING  
 ONE LANE CLOSURE  
 WITH "SPEED FINES DOUBLE" SIGNAGE  
 TWO LANE UNDIVIDED HIGHWAY





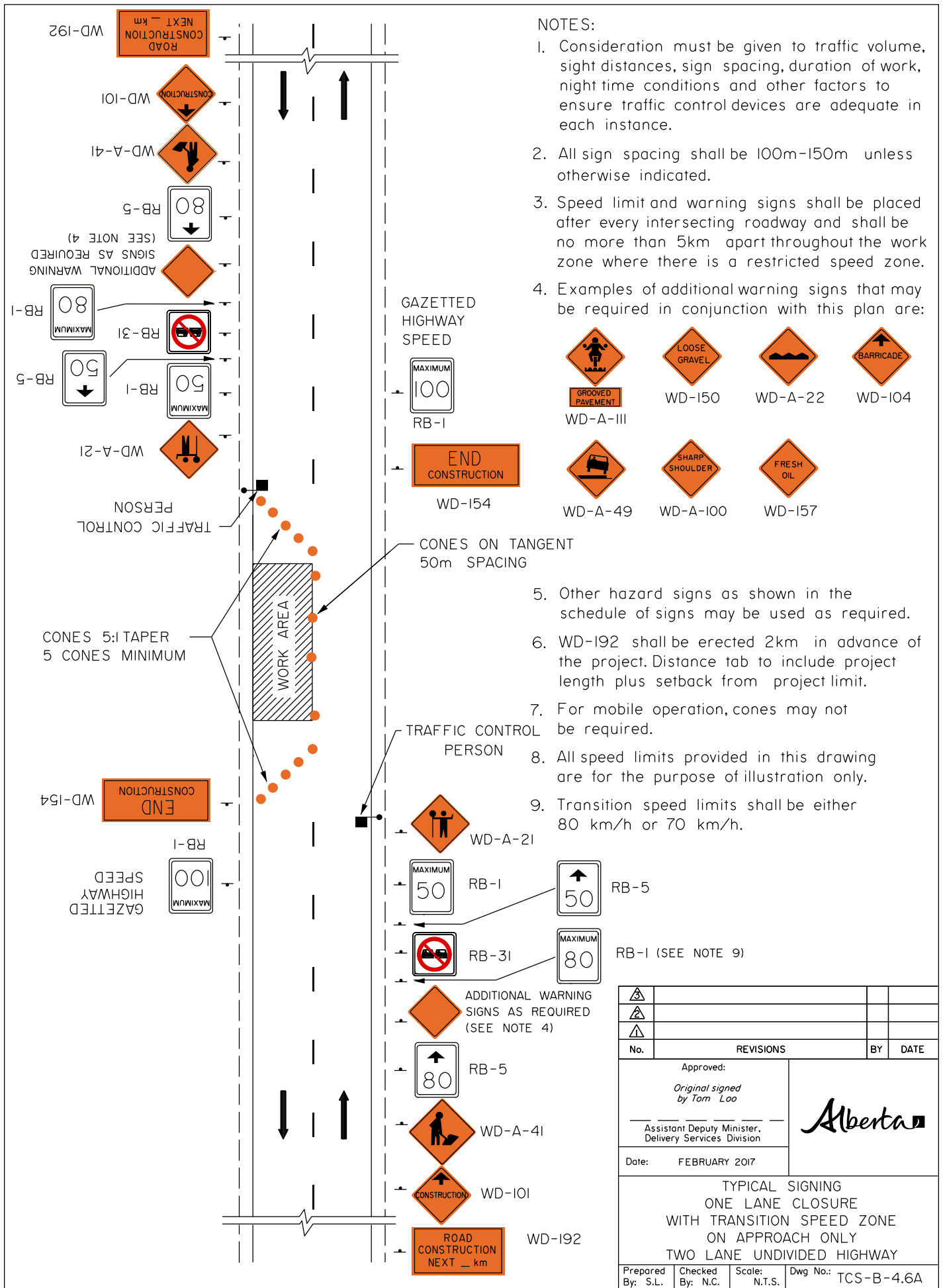

Prepared By: S.L.	Checked By: N.C.	Scale: N.T.S.	Dwg No.: TCS-B-4.4
-------------------	------------------	---------------	--------------------







**NOTES:**

1. Consideration must be given to traffic volume, sight distances, sign spacing, duration of work, night time conditions and other factors to ensure traffic control devices are adequate in each instance.
2. All sign spacing shall be 100m-150m unless otherwise indicated.
3. Speed limit and warning signs shall be placed after every intersecting roadway and shall be no more than 5km apart throughout the work zone where there is a restricted speed zone.
4. Examples of additional warning signs that may be required in conjunction with this plan are:
  -  WD-A-III
  -  WD-150
  -  WD-A-22
  -  WD-104
  -  WD-157
  -  WD-A-100
  -  WD-A-49
5. Other hazard signs as shown in the schedule of signs may be used as required.
6. WD-192 shall be erected 2km in advance of the project. Distance tab to include project length plus setback from project limit.
7. For mobile operation, cones may not be required.
8. All speed limits provided in this drawing are for the purpose of illustration only.
9. Transition speed limits shall be either 80 km/h or 70 km/h.





No.	REVISIONS	BY	DATE

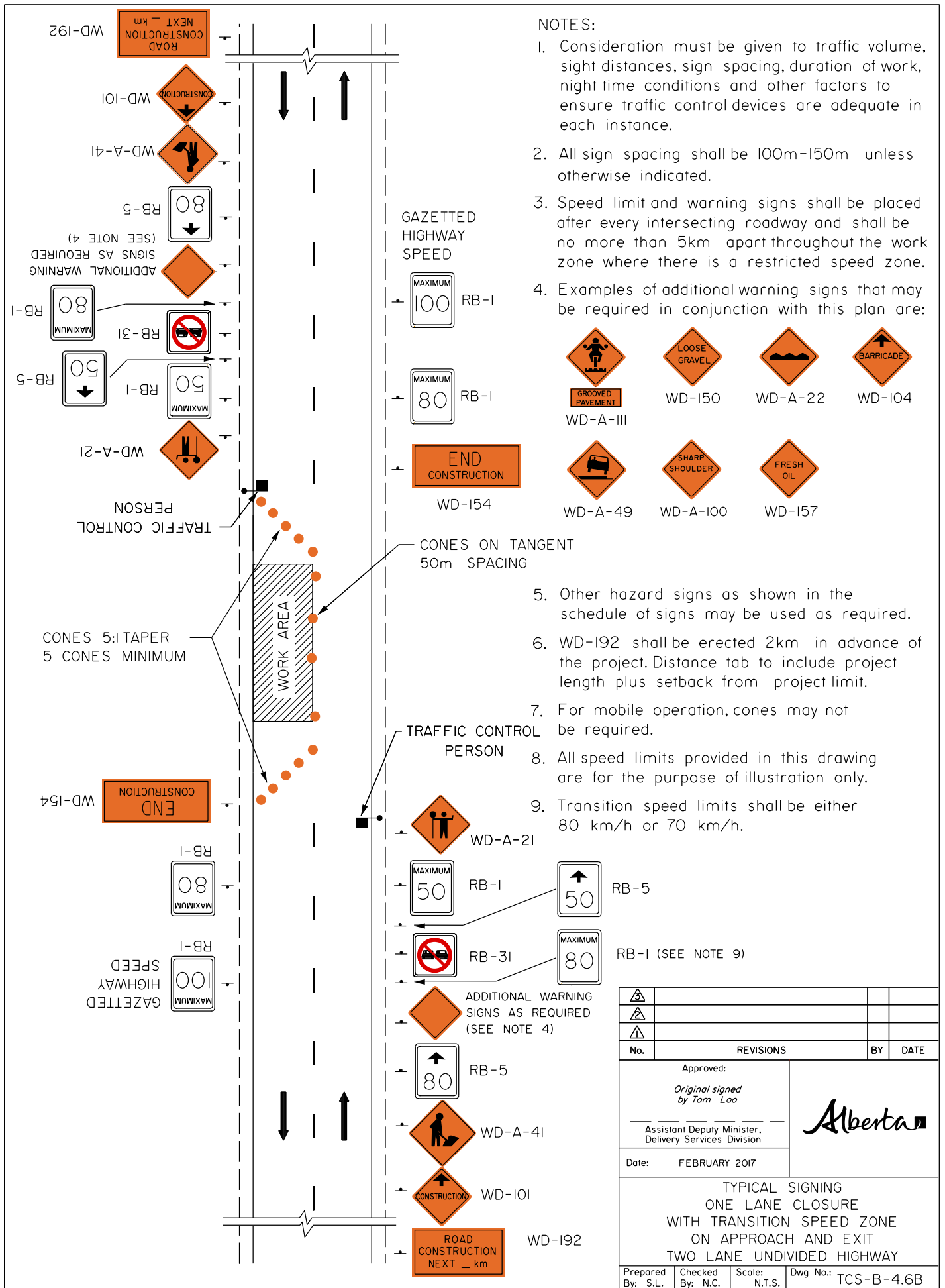

Approved:			
Original signed by Tom Loo			
Assistant Deputy Minister, Delivery Services Division		Date: FEBRUARY 2017	
TYPICAL SIGNING ONE LANE CLOSURE WITH TRANSITION SPEED ZONE ON APPROACH ONLY TWO LANE UNDIVIDED HIGHWAY			
Prepared By: S.L.	Checked By: N.C.	Scale: N.T.S.	Dwg No.: TCS-B-4.6A



**NOTES:**

1. Consideration must be given to traffic volume, sight distances, sign spacing, duration of work, night time conditions and other factors to ensure traffic control devices are adequate in each instance.
2. All sign spacing shall be 100m-150m unless otherwise indicated.
3. Speed limit and warning signs shall be placed after every intersecting roadway and shall be no more than 5km apart throughout the work zone where there is a restricted speed zone.
4. Examples of additional warning signs that may be required in conjunction with this plan are:
  -  GROOVED PAVEMENT (WD-A-III)
  -  LOOSE GRAVEL (WD-150)
  -  SHARP SHOULDER (WD-A-100)
  -  FRESH OIL (WD-157)
  -  BARRICADE (WD-104)
5. Other hazard signs as shown in the schedule of signs may be used as required.
6. WD-192 shall be erected 2km in advance of the project. Distance tab to include project length plus setback from project limit.
7. For mobile operation, cones may not be required.
8. All speed limits provided in this drawing are for the purpose of illustration only.
9. Transition speed limits shall be either 80 km/h or 70 km/h.

No.	REVISIONS	BY	DATE
Approved:			
Original signed by Tom Loo			
Assistant Deputy Minister, Delivery Services Division			
Date: FEBRUARY 2017			
TYPICAL SIGNING ONE LANE CLOSURE WITH TRANSITION SPEED ZONE ON APPROACH AND EXIT TWO LANE UNDIVIDED HIGHWAY			
Prepared By: S.L.	Checked By: N.C.	Scale: N.T.S.	Dwg No.: TCS-B-4.6B

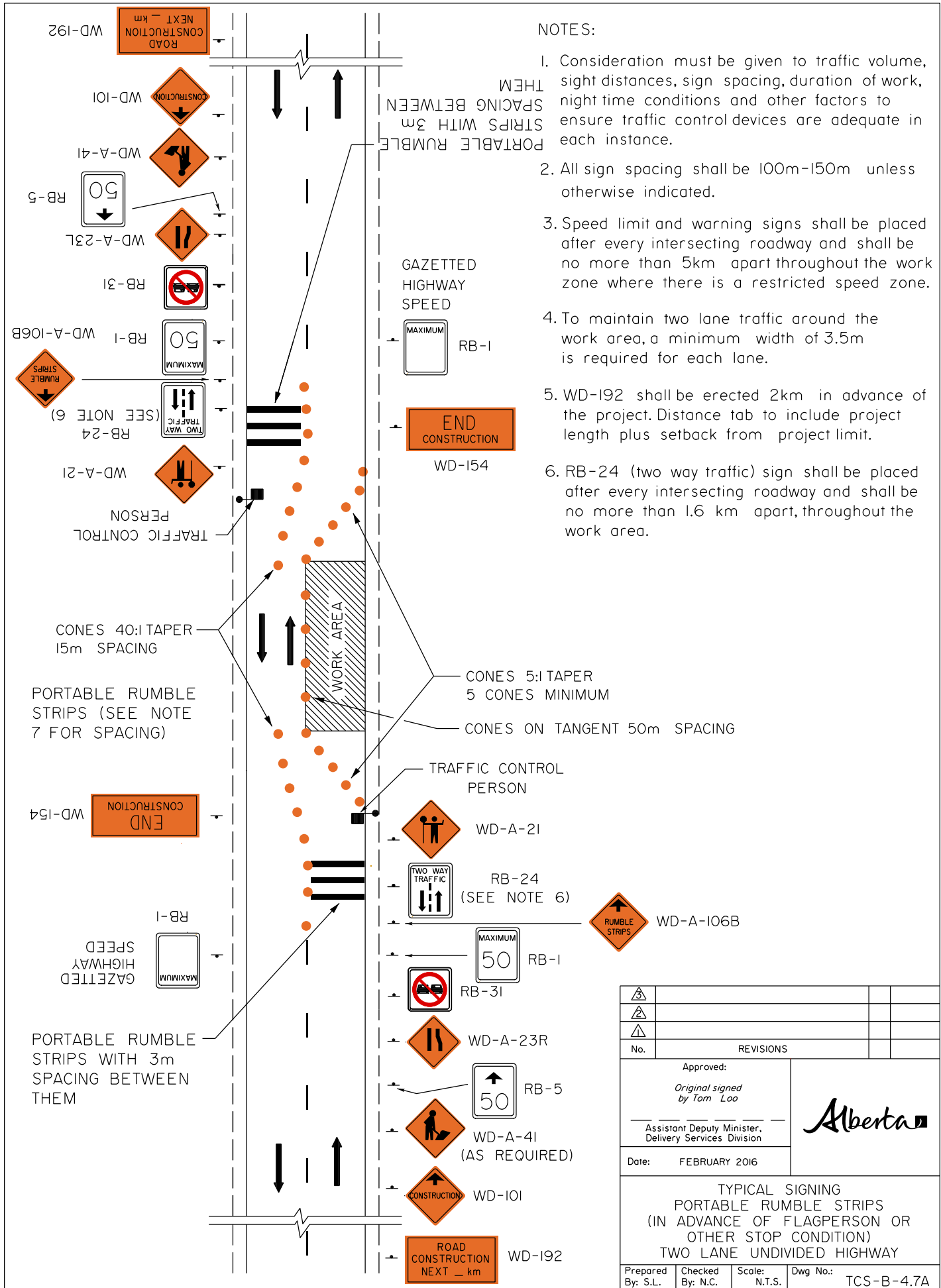

NOTES:

1. Consideration must be given to traffic volume, sight distances, sign spacing, duration of work, night time conditions and other factors to ensure traffic control devices are adequate in each instance.
2. All sign spacing shall be 100m-150m unless otherwise indicated.
3. Speed limit and warning signs shall be placed after every intersecting roadway and shall be no more than 5km apart throughout the work zone where there is a restricted speed zone.
4. To maintain two lane traffic around the work area, a minimum width of 3.5m is required for each lane.
5. WD-192 shall be erected 2km in advance of the project. Distance tab to include project length plus setback from project limit.
6. RB-24 (two way traffic) sign shall be placed after every intersecting roadway and shall be no more than 1.6 km apart, throughout the work area.

△			
△			
△			
No.	REVISIONS		
Approved:			
Original signed by Tom Loo			
Assistant Deputy Minister, Delivery Services Division		Date: FEBRUARY 2016	
TYPICAL SIGNING PORTABLE RUMBLE STRIPS (IN ADVANCE OF FLAGPERSON OR OTHER STOP CONDITION) TWO LANE UNDIVIDED HIGHWAY			
Prepared By: S.L.	Checked By: N.C.	Scale: N.T.S.	Dwg No.: TCS-B-4.7A

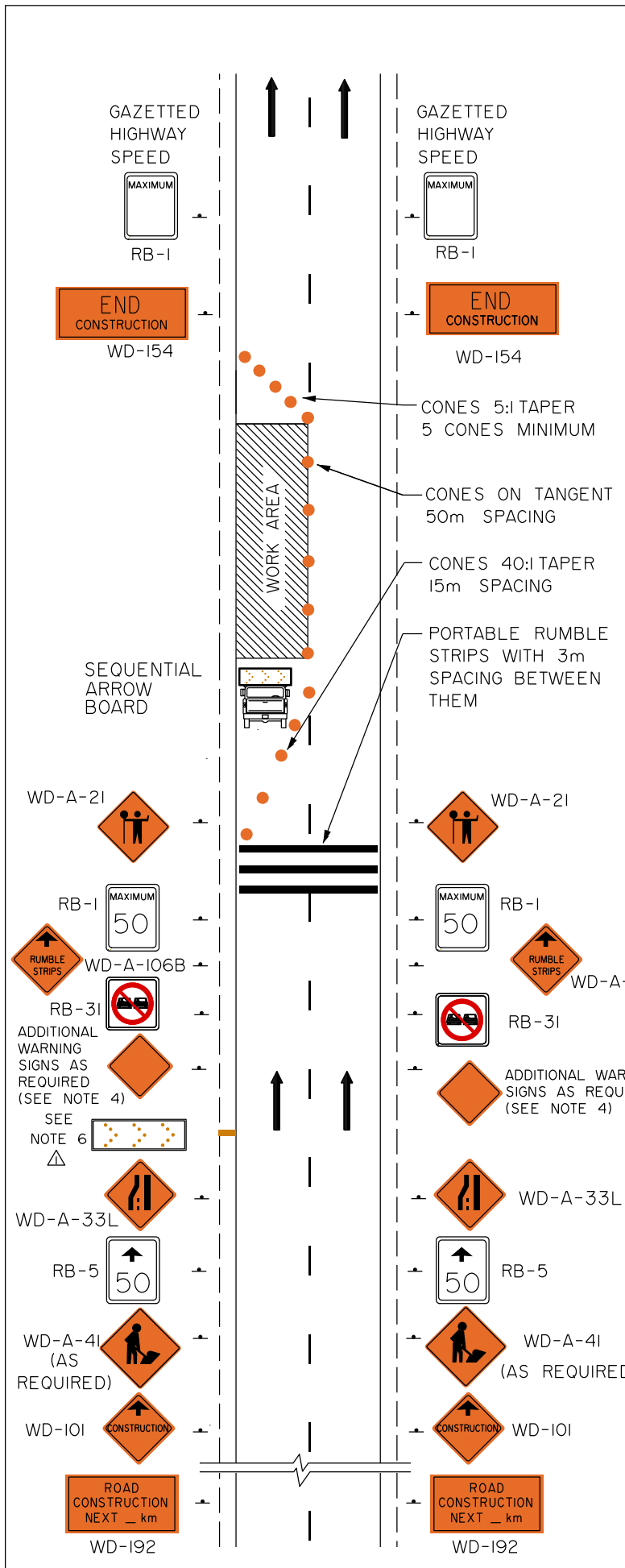

**NOTES:**

1. Consideration must be given to traffic volume, sight distances, sign spacing, duration of work, night time conditions and other factors to ensure traffic control devices are adequate in each instance.
2. All sign spacing shall be 100m-150m unless otherwise indicated.
3. Speed limit and warning signs shall be placed after every intersecting roadway and shall be no more than 5km apart throughout the work zone where there is a restricted speed zone.
4. Examples of additional warning signs that may be required in conjunction with this plan are:

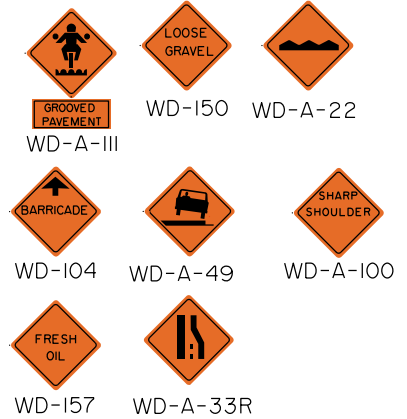

5. Other hazard signs as shown in the schedule of signs may be used as required.
6. The Sequential Arrow Board shall be located in the centre of the closed lane. An additional Sequential Arrow Board is required when traffic volume exceeds 10000 vehicles per day (ASDT) or when sight distance is restricted.
7. WD-I92 shall be erected 2km in advance of the project. Distance tab to include project length plus setback from project limit.
8. For mobile operation, cones may not be required.

▲			
▲			
▲			
No.	REVISIONS	BY	DATE
Approved: <i>Original signed by Tom Loo</i>			
Assistant Deputy Minister, Delivery Services Division			
Date:	FEBRUARY 2016		
TYPICAL SIGNING PORTABLE RUMBLE STRIPS (IN ADVANCE OF FLAGPERSON OR OTHER STOP CONDITION) FOUR LANE DIVIDED HIGHWAY			
Prepared By: S.L.	Checked By: N.C.	Scale: N.T.S.	Dwg No.: TCS-B-4.7B



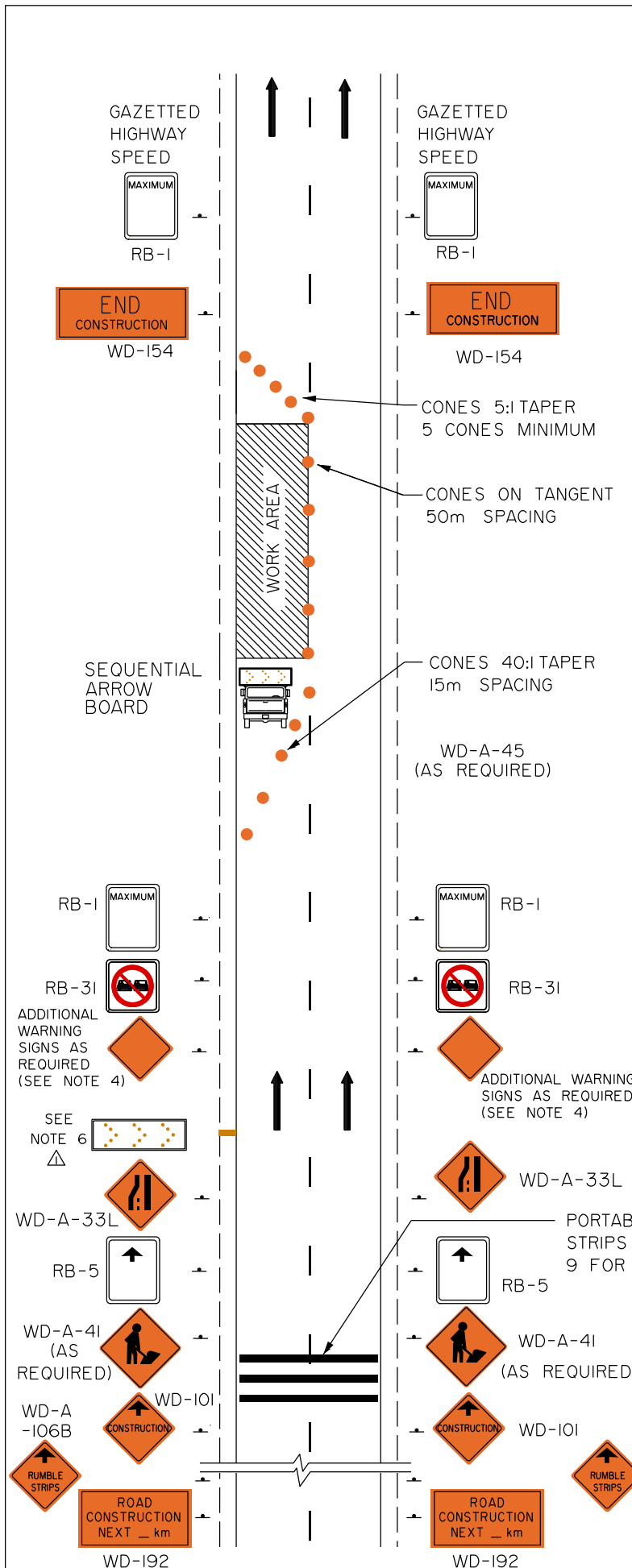

NOTES:

1. Consideration must be given to traffic volume, sight distances, sign spacing, duration of work, night time conditions and other factors to ensure traffic control devices are adequate in each instance.
2. All sign spacing shall be 100m-150m unless otherwise indicated.
3. Speed limit and warning signs shall be placed after every intersecting roadway and shall be no more than 5km apart throughout the work zone where there is a restricted speed zone.
4. Examples of additional warning signs that may be required in conjunction with this plan are:

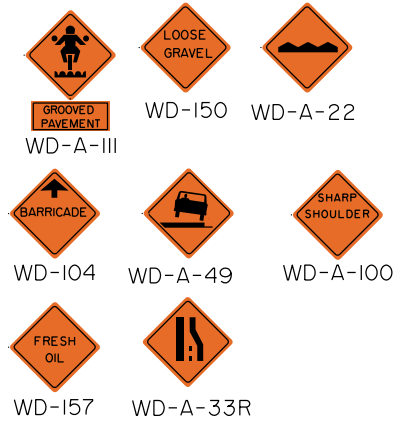

5. Other hazard signs as shown in the schedule of signs may be used as required.
6. The Sequential Arrow Board shall be located in the centre of the closed lane. An additional Sequential Arrow Board is required when traffic volume exceeds 10000 vehicles per day (ASDT) or when sight distance is restricted.
7. WD-I92 shall be erected 2km in advance of the project. Distance tab to include project length plus setback from project limit.
8. For mobile operation, cones may not be required.
9. Spacing between strips is 3.0 m for speed limits of 60 km/h or lower, 4.5 m for speed limits between 61 km/h and 90 km/h and 6.0 m for speed limits higher than 90 km/h.

▲			
▲			
▲			
No.	REVISIONS	BY	DATE
Approved:			
Original signed by Tom Loo			
Assistant Deputy Minister, Delivery Services Division			
Date:	FEBRUARY 2016		
TYPICAL SIGNING PORTABLE RUMBLE STRIPS (IN ADVANCE OF "STOP AND GO" TRAFFIC CONDITION) FOUR LANE DIVIDED HIGHWAY			
Prepared By: S.L.	Checked By: N.C.	Scale: N.T.S.	Dwg No.: TCS-B-4.7D



WD-101  
1200 x 1200

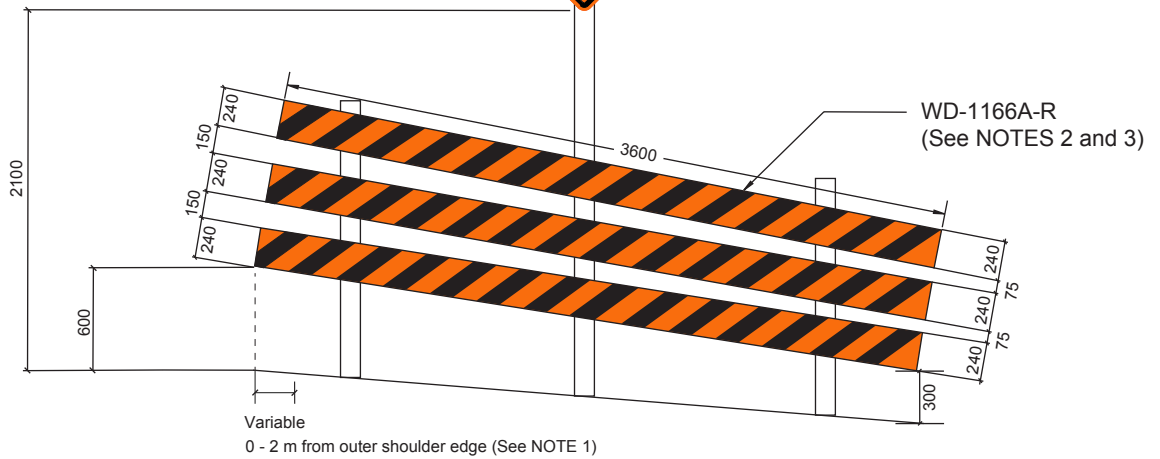

### ENTERING A WORK ZONE

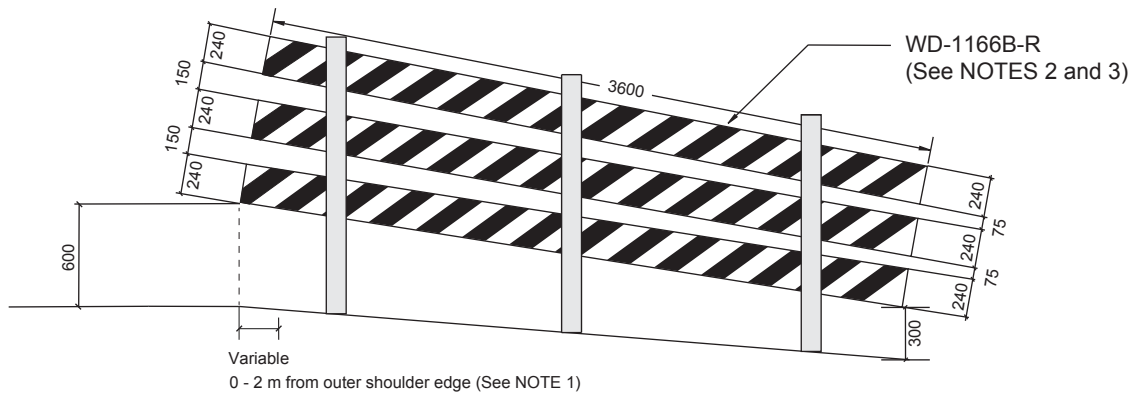

### EXITING A WORK ZONE

#### NOTES:

1. No offset from the outer shoulder edge is preferred. However, based on site-specific judgment, gateway assemblies may be moved up to 2m from the outer shoulder edge to accommodate wide loads.
2. The orange portion of the sign must meet or exceed ASTM Type VIII sheeting requirements. All other colours shall meet or exceed ASTM Type III or IV sheeting requirements.
3. For undivided highways, gateway assembly patterns shall be printed back-to-back on the same board. WD-1166A-R and WD-1166B-L would be on opposite sides of one assembly and WD-1166A-L and WD-1166B-R would make up the other assembly.

No.	REVISIONS	BY	DATE
Approved:			
Assistant Deputy Minister, Delivery Services Division			
Date:	MAY 2017		
GATEWAY ASSEMBLIES			
Prepared By: S.L.	Checked By: N.C.	Scale: N.T.S.	Dwg No.: TCS-B-4.8A

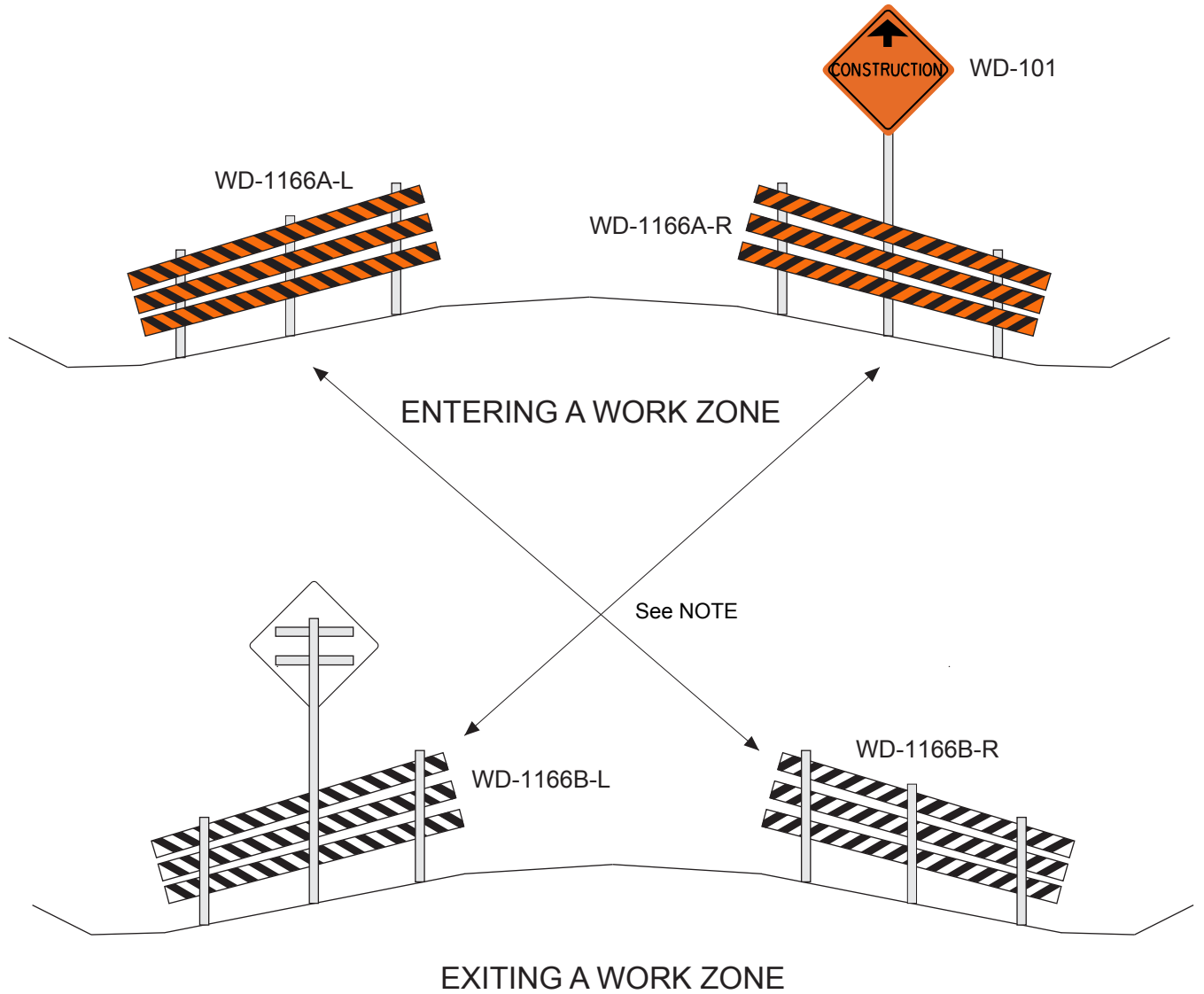

**NOTE:**

For undivided highways, gateway assembly patterns shall be printed back-to-back on the same board. WD-1166A-R and WD-1166B-L would be on opposite sides of one assembly and WD-1166A-L and WD-1166B-R would make up the other assembly.

No.	REVISIONS	BY	DATE
Approved:			
Assistant Deputy Minister, Delivery Services Division			
Date:	MAY 2017		
GATEWAY ASSEMBLIES RURAL UNDIVIDED HIGHWAY			
Prepared By: S.L.	Checked By: N.C.	Scale: N.T.S.	Dwg No.: TCS-B-4.8B



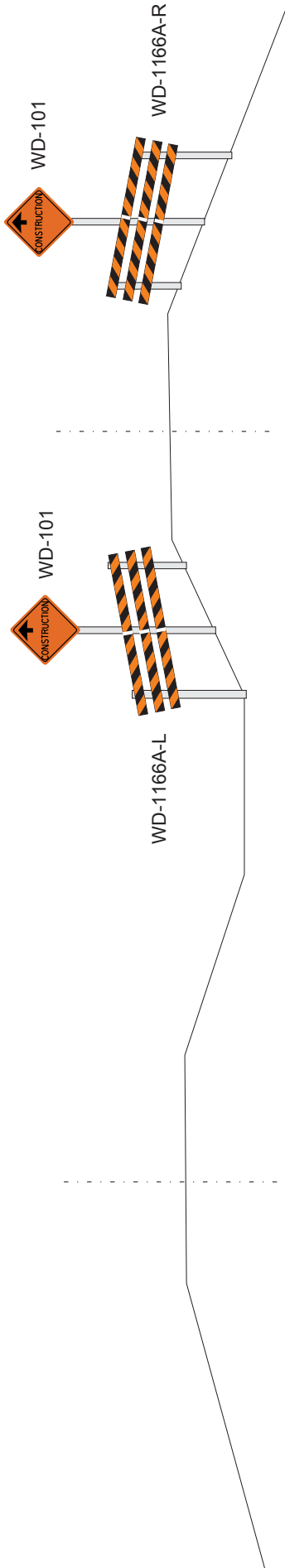

**CONSTRUCTION GATE ASSEMBLIES  
4-LANE DIVIDED HIGHWAY FORMAT**

**ENTERING CONSTRUCTION SITE  
(FRONT VIEW)**

No.	REVISIONS	BY	DATE
Approved:			
_____ Assistant Deputy Minister, Delivery Services Division			
Date:	MAY 2017		
GATEWAY ASSEMBLIES RURAL DIVIDED HIGHWAY WITH DEPRESSION MEDIAN			
Prepared By: S.L.	Checked By: N.C.	Scale: N.T.S.	Dwg No.: TCS-B-4.8C

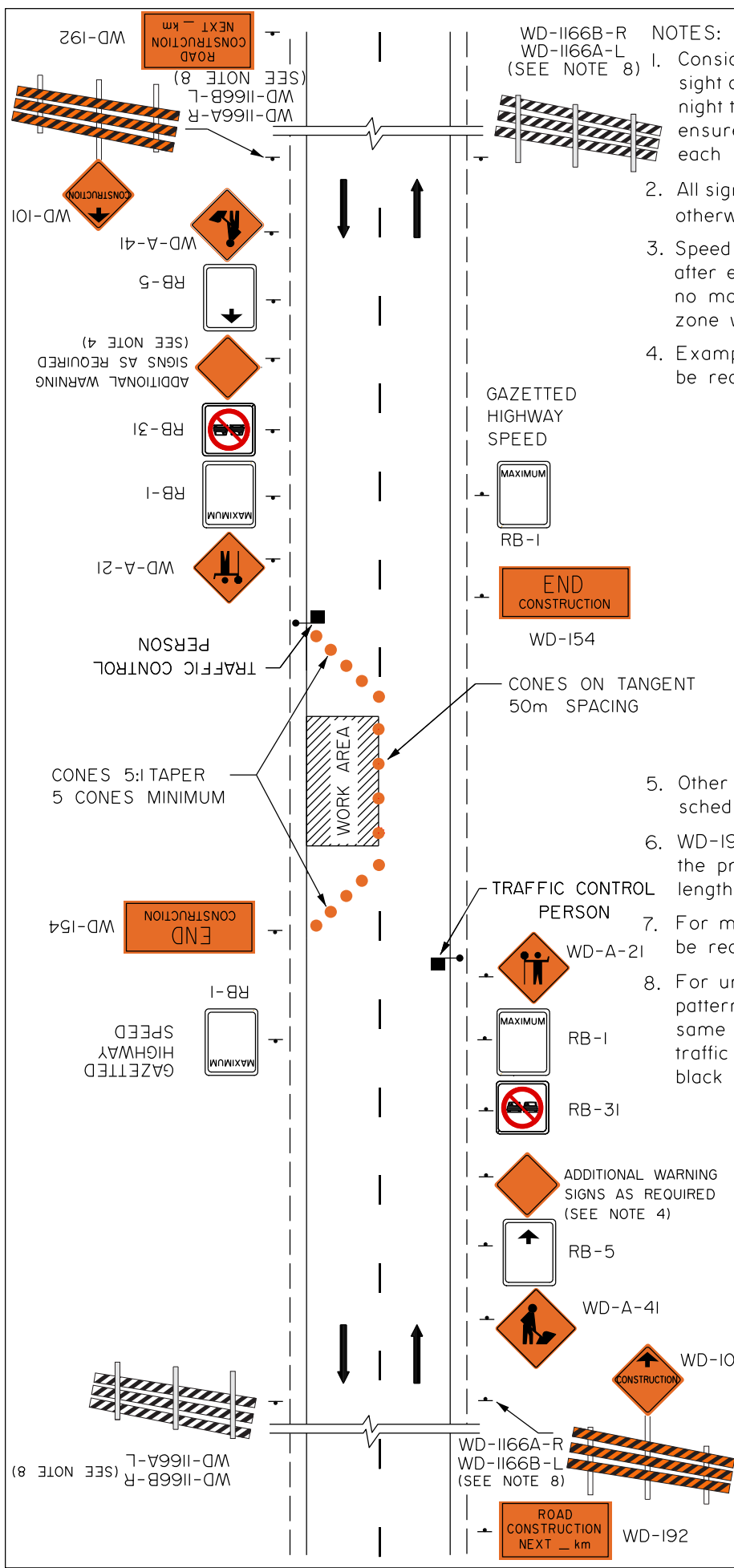

WD-1166B-R  
WD-1166A-L  
(SEE NOTE 8)

- NOTES:
1. Consideration must be given to traffic volume, sight distances, sign spacing, duration of work, night time conditions and other factors to ensure traffic control devices are adequate in each instance.
  2. All sign spacing shall be 100m-150m unless otherwise indicated.
  3. Speed limit and warning signs shall be placed after every intersecting roadway and shall be no more than 5km apart throughout the work zone where there is a restricted speed zone.
  4. Examples of additional warning signs that may be required in conjunction with this plan are:

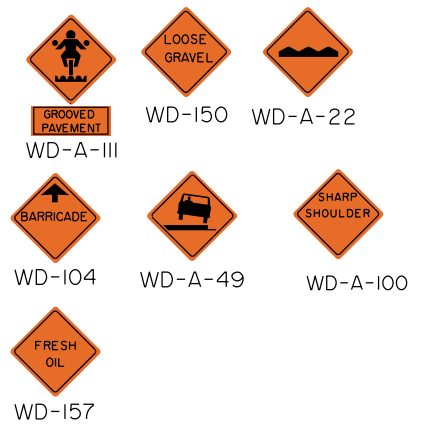

5. Other hazard signs as shown in the schedule of signs may be used as required.
6. WD-192 shall be erected 2km in advance of the project. Distance tab to include project length plus setback from project limit.
7. For mobile operation, cones may not be required
8. For undivided highways, gateway assembly patterns shall be printed back-to-back on the same board. The orange and black side faces traffic entering the work zone while the black and white side faces exiting traffic.

CONES 5:1 TAPER  
5 CONES MINIMUM

CONES ON TANGENT  
50m SPACING

No.	REVISIONS	BY	DATE
Approved:			
Original signed by Tom Loo			
Assistant Deputy Minister, Delivery Services Division			
Date:	FEBRUARY 2017		
TYPICAL SIGNING ONE LANE CLOSURE WITH GATEWAY ASSEMBLIES TWO LANE UNDIVIDED HIGHWAY			
Prepared By: S.L.	Checked By: N.C.	Scale: N.T.S.	Dwg No.: TCS-B-4.8D

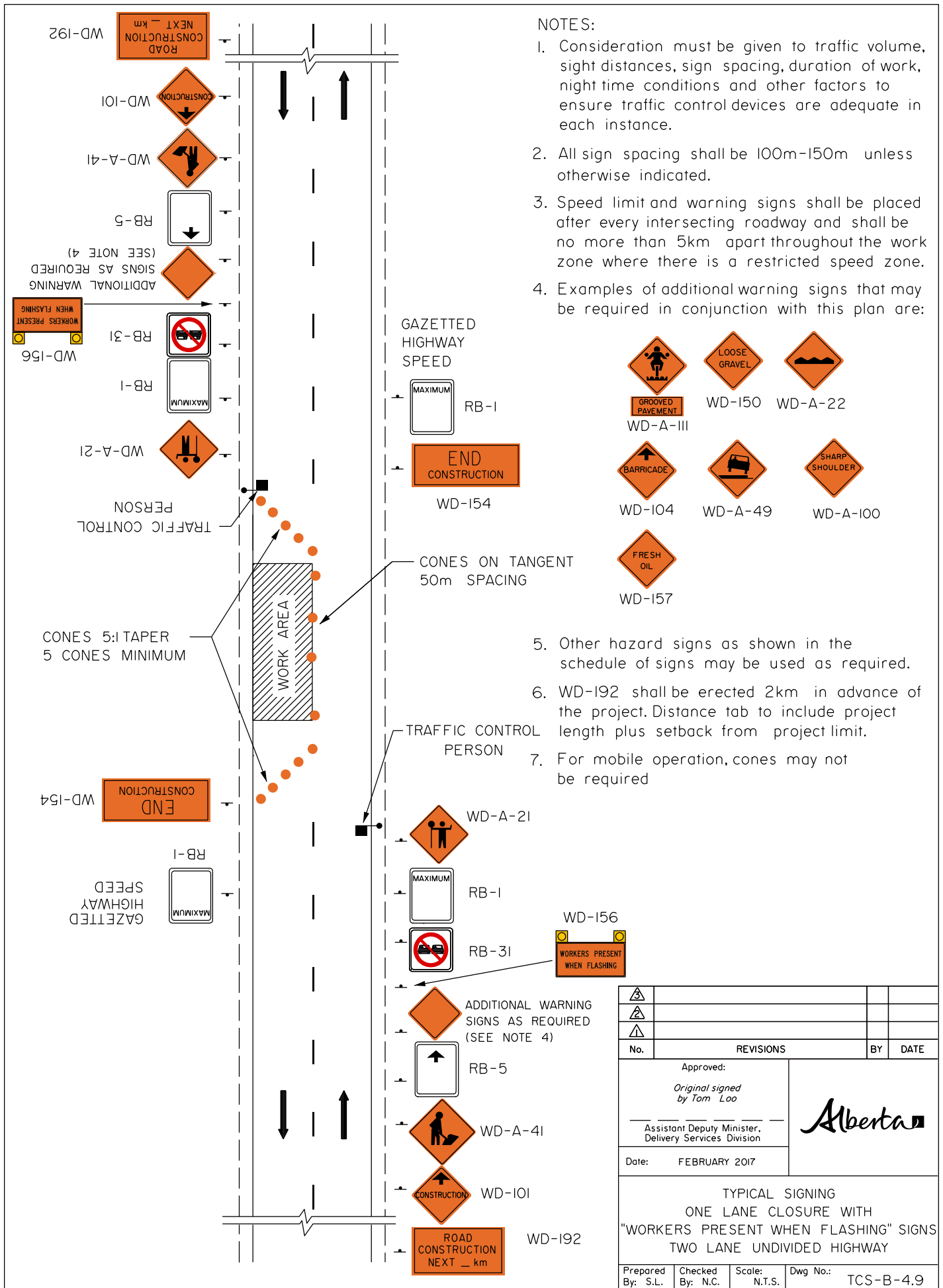

**NOTES:**

1. Consideration must be given to traffic volume, sight distances, sign spacing, duration of work, night time conditions and other factors to ensure traffic control devices are adequate in each instance.
2. All sign spacing shall be 100m-150m unless otherwise indicated.
3. Speed limit and warning signs shall be placed after every intersecting roadway and shall be no more than 5km apart throughout the work zone where there is a restricted speed zone.
4. Examples of additional warning signs that may be required in conjunction with this plan are:

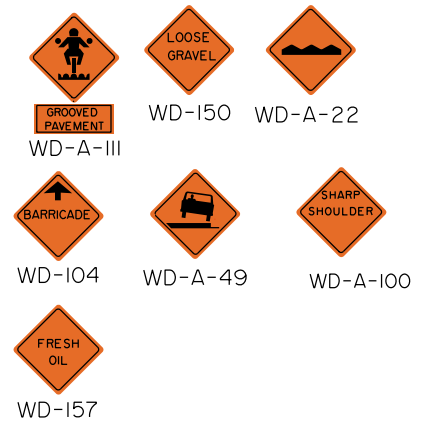

5. Other hazard signs as shown in the schedule of signs may be used as required.
6. WB-192 shall be erected 2km in advance of the project. Distance tab to include project length plus setback from project limit.
7. For mobile operation, cones may not be required

▲			
▲			
▲			
No.	REVISIONS	BY	DATE
Approved:			
Original signed by Tom Loo			
Assistant Deputy Minister, Delivery Services Division			
Date:	FEBRUARY 2017		
<b>TYPICAL SIGNING</b> ONE LANE CLOSURE WITH "WORKERS PRESENT WHEN FLASHING" SIGNS TWO LANE UNDIVIDED HIGHWAY			
Prepared By: S.L.	Checked By: N.C.	Scale: N.T.S.	Dwg No.: TCS-B-4.9

## TRAFFIC ACCOMMODATION IN WORK ZONES

### LIST OF DRAWINGS

Click the links below to get to the drawings. To go back to the Drawings by Category Table of Contents: click [here](#)

EMERGENCY ACTIVITIES			
TCS-B Drawing No.	2 Lane Undivided	4 Lane Divided	Description
<a href="#">TCS-B-8.1</a>			<a href="#">Four Lane to Two Lane Emergency Detour</a>
<a href="#">TCS-B-8.3A</a>	X		<a href="#">Emergency Agency Response One Lane Closure Two Lane Undivided Highway</a>
<a href="#">TCS-B-8.3B</a>		X	<a href="#">Emergency Agency Response One Lane Closure Four Lane Divided Highway</a>



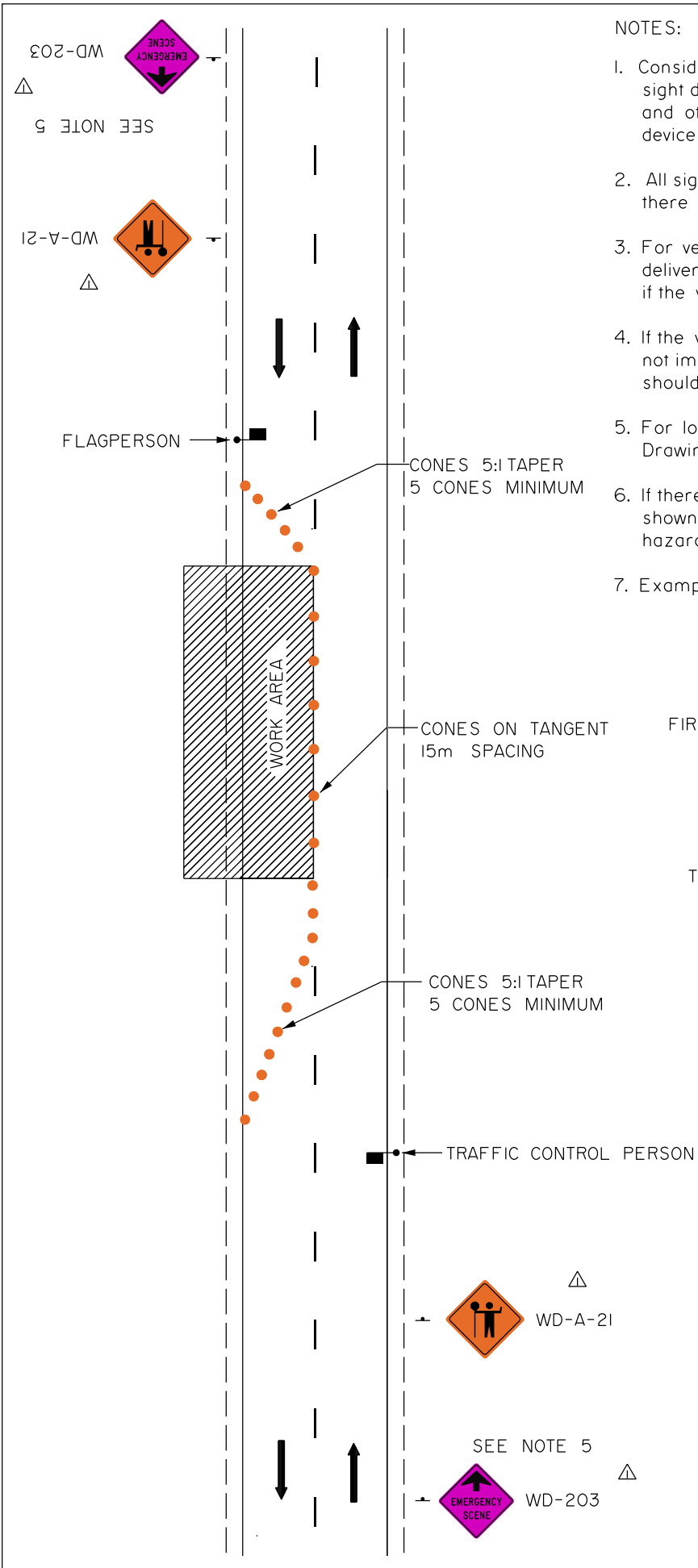

NOTES:

1. Consideration must be given to traffic volume, sight distances, sign spacing, duration of work and other factors to ensure traffic control devices are adequate in each instance.
2. All sign spacing shall be 100m-150m unless there are sight restrictions.
3. For very short assistance, tire replacement, delivery of fuel, etc. signs may not be required if the vehicle does not encroach the driving lane.
4. If the vehicle is parked on the shoulder, not impeding the traffic lane, traffic cones should be placed around the vehicle.
5. For load transfer or retrieval, short duration Drawing No. TCS-B-2.1A must be used.
6. If there is no lane closure, the signage as shown on this drawing will not apply. Other hazard signs may be used as required.
7. Examples of other Warning signs that may be used:

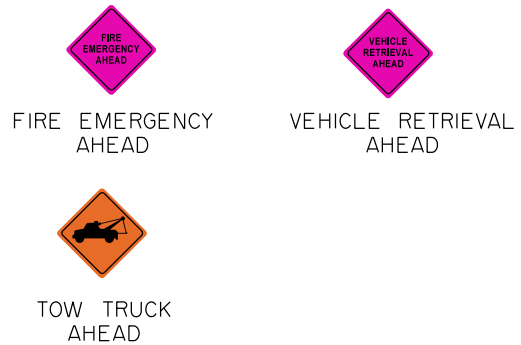

	Signs updated.	EY	Nov 30/18
No.	REVISIONS	BY	DATE
Approved: Original signed by Allan Kwan Executive Director, Technical Standards Branch			
Date: OCTOBER, 2008			
EMERGENCY AGENCY RESPONSE ONE LANE CLOSURE TWO LANE UNDIVIDED HIGHWAY			
Prepared By: G.E.C.	Checked By: J.M.	Scale: N.T.S.	Dwg No.: TCS-B-8.3A

NOTES:

1. Consideration must be given to traffic volume, sight distances, sign spacing, duration of work and other factors to ensure traffic control devices are adequate in each instance.
2. All sign spacing shall be 100m-150m unless there are sight restrictions.
3. For very short assistance, tire replacement, delivery of fuel, etc. signs may not be required if the vehicle does not encroach the driving lane.
4. If the vehicle is parked on the shoulder, not impeding the traffic lane, traffic cones should be placed around the vehicle.
5. For load transfer or retrieval, short duration Drawing No. TCS-B-2.1B must be used.
6. If there is no lane closure, the signage as shown on this drawing will not apply. Other hazard signs may be used as required.
7. Examples of other Warning signs that may be used:



FIRE EMERGENCY AHEAD



WD-A-33L



TOW TRUCK AHEAD



VEHICLE RETRIEVAL AHEAD

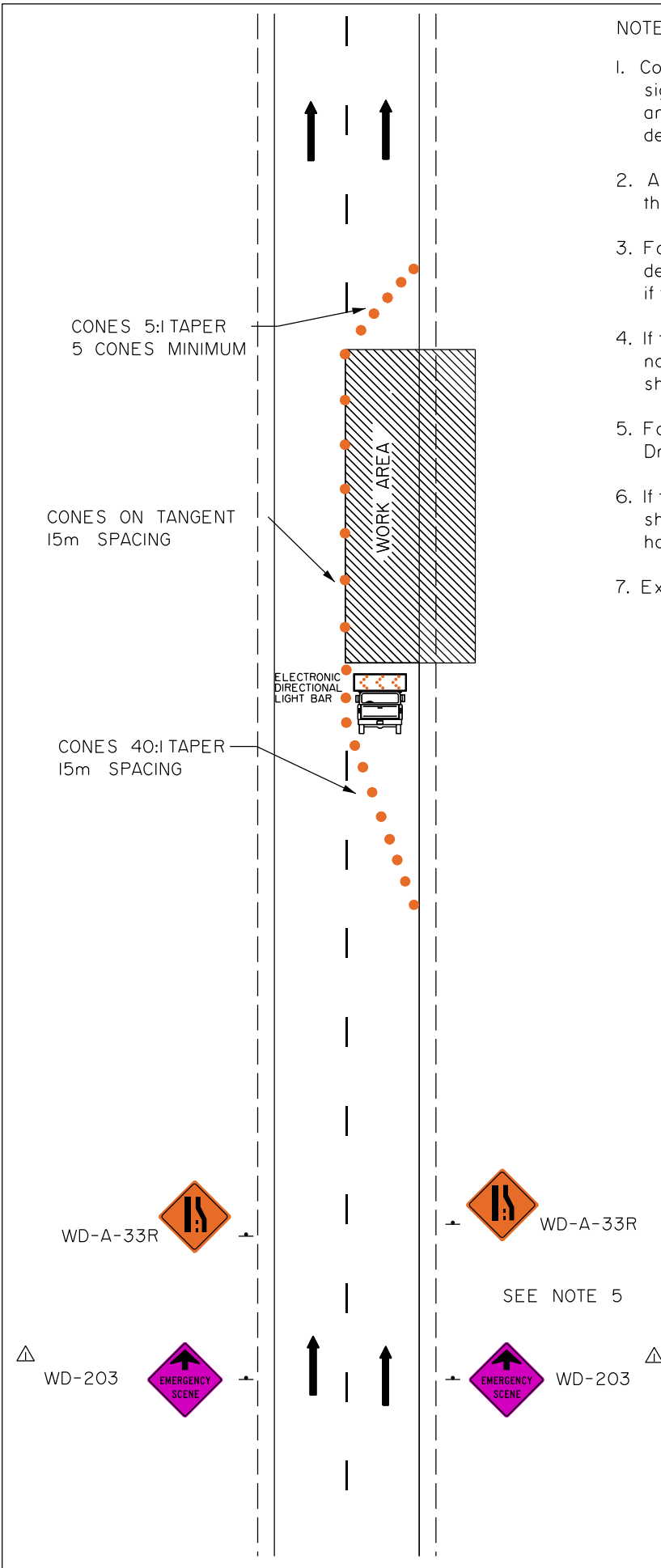

△			
△			
△	Signs updated.	EY	Nov 30/18
No.	REVISIONS	BY	DATE
Approved: Original signed by Allan Kwan Executive Director, Technical Standards Branch			
Date:	OCTOBER, 2008		
EMERGENCY AGENCY RESPONSE ONE LANE CLOSURE FOUR LANE DIVIDED HIGHWAY			
Prepared By: G.E.C.	Checked By: J.M.	Scale: N.T.S.	Dwg No.: TCS-B-8.3B

**APPENDIX B**

**WORK ZONE BULLETINS**



## TRAFFIC ACCOMMODATION IN URBAN WORK ZONES

WORK ZONE BULLETINS	
NO.	Description
1	<a href="#">"Speed Fines Double" Signage</a>
2	<a href="#">"Late Merge (Zipper Merge) Traffic Accommodation Strategy</a>
3	<a href="#">Transition Speed Zones</a>
4	<a href="#">Driver (Speed) Feedback Signs</a>
5	<a href="#">Portable Rumble Strips</a>
6	<a href="#">Gateway Assemblies</a>
7	<a href="#">"Workers Present When Flashing" Signs</a>
8	<a href="#">Alternatives to Manual Flagging</a>
9	<a href="#">Police Enforcement</a>
10	<a href="#">Lane Rental and Speed Reduction</a>
11	<a href="#">Smart Work Zones</a>
12	<a href="#">Digital Speed Limit Signs</a>

## WORK ZONE BULLETIN #1/2017

### “Speed Fines Double” Signage

#### Summary

This Bulletin is issued to inform consultants, contractors, and department staff of the department’s practice for the use of “Speed Fines Double” signs.

The sign was first introduced in “Design Bulletin #41/2006” to remind motorists of legislated penalties for speeding in active work zones. The Design Bulletin was superseded in 2008 when Alberta Transportation’s *Traffic Accommodation in Work Zones* was released. While the manual describes how to use and place “Speed Fines Double” signs, it does not identify the situations where the signs should be applied. This bulletin provides a criteria as well as a revised signing sequence.

#### Key Changes

The existing Section 10. Double Fines in Work Zones of *Traffic Accommodation in Work Zones* is rescinded and replaced with the following:

##### *Section 10. Double Fines in Work Zones*

*“Double Fine Begins” and “Double Fine Ends” signs are used to define the active work areas where the workers are actually present. Where there are no active work areas, these signs must be covered and/or removed. If the work zone uses transition speed zones, the “Double Fine” signs are placed in conjunction with the lowest work zone speed limit. Drawing TCS-B-4.4 shall be used as a reference when incorporating “Double Fine Begins” and “Double Fine Ends” signs into the project signage strategy.*

*The signs must be used for all stationary projects that are five days or more, where the highway speed limit is greater than 70 km/h when not under construction. The signs can be used for shorter duration projects, mobile work, or lower speed situations where practical.*

*In situations where the signs are not used but workers are present, motorists can still be issued double fines. The purpose of the signs is only to reinforce and remind drivers of existing legislation.*

**Effective Date**

May 9, 2017

**Contact**

Elena Yin at (780) 415-4827

Operations, Programming and Planning Branch, Alberta Transportation

**References**

“Design Bulletin #41/2006” (superseded)

[Traffic Accommodation in Work Zones \(2008 edition\)](#)

**Approved**

*Original signed  
by Tom Loo*

---

Tom Loo  
Assistant Deputy Minister, Delivery Services Division

**WORK ZONE BULLETIN #2/2017****Late Merge (Zipper Merge) Traffic Accommodation Strategy****Summary**

“Design Bulletin #85/2015”, now superseded, recognized the late merge (zipper merge) as an effective traffic accommodation strategy for work zones when applied under certain conditions. This Bulletin is being issued to present minor modifications to guidance for using the zipper merge strategy on provincial highways. It also serves to consolidate the strategy under Alberta Transportation’s work zone practices.

**Background**

The nature of work zones and lane closures are such that some level of delay is inevitable. However, when used appropriately, certain lane closure and merging strategies are able to improve traffic flow, reduce delays, and increase safety.

Merge situations tend to generate speed differentials between the open and closed lanes. This may lead to aggressive driving maneuvers, including drivers using a nearly empty closed lane to pass queued vehicles, before darting back into the open lane just before the merge point. Aggressive driving can increase the probability of work zone collisions and road rage.

Generally, most drivers have learned that when they see the first lane closure signs in a work zone, they slow down and move to the lane that will continue through the construction area. This is not always the most efficient and safe way for traffic to merge. The best traffic merging strategy is based on the prevailing traffic conditions.

**Early Merge Strategy**

The early merge strategy is most effective when there are low traffic volumes on the road combined with high average speeds.

The early merge strategy instructs drivers to move out of the closed lane well before the forced merge point, and before traffic starts to backup.

**Late Merge (Zipper Merge) Strategy**

The late merge strategy is most effective when there are high traffic volumes on the road combined with low average speeds due to congestion.

The late merge strategy instructs drivers in the closed lane(s) to remain in their respective lane(s) until they reach the designated merge point, at which time they enter the open lane in alternate turns with the traffic already travelling in this lane.

Potential benefits of the implementation of a late merge strategy include the following:

- Reduced travel times
- Decreased number of work zone related incidents
- Reduced aggressive driving
- Increased traffic capacity through the work zone
- Shortened queue lengths before the work zones

## **Key Changes**

### *Merging Strategies for Multi-lane Highways*

The late merge strategy should be used on all lane closures (long duration and short duration) for multi-lane highway work zones, where the traffic volume is over the following threshold:

- Rural highways: 1000 vph in each direction for at least 2 hours per day
- Urban highways: 1500 vph in each direction for at least 2 hours a day

When traffic volumes are lower than the threshold, the early merge strategy shall be used.

### *Standard*

The layout shown on Drawing TCS-B-4.5 shall be used as a reference when developing the zipper merge signage strategy for the project.

When appropriate, the following alternate messages may be displayed on the portable changeable message signs in place of the one shown in Note 6 of the attached drawing.

- USE BOTH LANES / TO MERGE POINT
- STAY IN YOUR LANE / MERGE AHEAD
- USE BOTH LANES / SLOW TRAFFIC AHEAD

**Effective Date**

May 9, 2017

**Contact**

Elena Yin at (780) 415-4827

Operations, Programming and Planning Branch, Alberta Transportation

**References**

“Design Bulletin #85/2015” (superseded)

**Approved**

*Original signed  
by Tom Loo*

---

Tom Loo  
Assistant Deputy Minister, Delivery Services Division

## WORK ZONE BULLETIN #3/2017

### Transition Speed Zones

#### Summary

This Bulletin is issued to inform consultants, contractors, and department staff of the department's revised practice for the use of transition speeds in work zones. Transition speed zones give motorists the opportunity to gradually reduce their speed as they approach a work zone.

#### Key Changes

The existing Section 4.5 Transitional Speed Reductions in Alberta Transportation's *Traffic Accommodation in Work Zones* is rescinded and replaced with the following:

#### *Section 4.5 Transitional Speed Reductions*

*Transition speeds are used on all long duration projects where the gazetted highway speed in advance of the Work Zone is greater than 30 km/h above the posted speed in the Work Zone. The transition speed can be either 70 or 80 km/h and shall be a minimum of 300 m in length. Drawings TCS-B-4.6A and TCS-B-4.6B shall be used as references when incorporating transition speed limit signs into a work zone signage strategy.*

*In most cases, transition speed zones will be applied only to the approach of the work zone and not to the exit. Motorist compliance to an exit transition speed zone is likely to be low if there are no longer any apparent hazards or risks. However, this method creates an area of differential speeds between the two directions of traffic. When considering whether to include a transition speed zone for motorists leaving the work zone, the roadway shall be evaluated based on the criteria outlined in Recommended Practices for Differential Speed Zones.*

#### Effective Date

May 9, 2017

#### Contact

Elena Yin at (780) 415-4827

Operations, Programming and Planning Branch, Alberta Transportation

#### References

[Traffic Accommodation in Work Zones \(2008 edition\)](#)

["Recommended Practices for Differential Speed Zones"](#)

#### Approved

**Approved**

*Original signed  
by Tom Loo*

---

Tom Loo  
Assistant Deputy Minister, Delivery Services Division



## WORK ZONE BULLETIN #4/2017

### Driver (Speed) Feedback Signs

#### Summary

This Bulletin is issued to inform consultants, contractors and department staff of the department's practice for the use of Driver (Speed) Feedback signs in work zones. The department's "Recommended Practices Driver (Speed) Feedback Signs" provide extensive operation and standard information about the signs as well as general recommendations for use. However, a need was identified to provide more specific guidance on the use of these signs for work zones.

#### Key Changes

##### *Type of Project*

Driver Feedback signs should be applied for work zone situations that have a potential to have speed-related issues based on the past history of similar projects. Examples of behaviors that may have existed in those projects include:

- Collisions or near misses on the approach to or in the work zone
- Aggressive braking by motorists (for example, at stop conditions or near queues)
- Low compliance to the work zone speed limit
- Worker or public complaints about safety

##### *Sign Standard, Operation, and Placement*

The sign standard, operation and general placement requirements are outlined in "Recommended Practices Driver (Speed) Feedback Signs". One Driver Feedback sign shall be placed on each approach to the work zone. When a work zone covers a large distance, placing more than one Driver Feedback sign for each approach can be considered.

When a transition speed limit is posted, the Driver Feedback sign shall be placed at least 150 metres downstream of the RB-1 sign that is associated with the speed transition zone. In such a case, it shall be placed prior to the lowest work zone speed limit. For projects without a transition speed limit, the Driver Feedback sign shall be placed at least 150 metres downstream of the RB-1 sign that displays the work zone speed limit. Where there is a flagperson present, the Driver Feedback sign shall be placed between the WD-A-45 sign and the RB-1 sign.

When the work zone speed limit is not in place, the RB-1 sign on the Driver Feedback sign shall be covered, and the electronic display shall be blank.

**Effective Date**

May 9, 2017

**Contact**

Elena Yin at (780) 415-4827

Operations, Programming and Planning Branch, Alberta Transportation

**References**

["Recommended Practices Driver \(Speed\) Feedback Signs"](#)

**Approved**

*Original signed  
by Tom Loo*

---

Tom Loo  
Assistant Deputy Minister, Delivery Services Division

**WORK ZONE BULLETIN #5/2017****Portable Rumble Strips****Summary**

This Bulletin is issued to inform consultants, contractors and department staff of the department's practice for the use of portable rumble strips in work zones. Portable rumble strips can be installed and removed from the roadway easily without any anchoring such as adhesives or nails. They provide additional warning cues to motorists through their sound and vibration. Portable rumble strips remind motorists of the need for full attention and caution through the work zone due to the potential for hazards and risks.

**Key Changes***Type of Project*

Portable rumble strips should be applied for short or long duration projects where motorists are approaching a stop condition, such as one controlled by a flagperson, or where "stop and go" conditions are expected due to vehicle queues. Their use should be limited to stationary projects in rural locations where the highway gazetted speed is 100 or 110 km/h when not under construction. Examples of projects where they might be used include roadway grading, widening or bridge repair.

Rumble strips may not be used on a project if there is concern about noise due to the proximity of residences. Factors to be considered in such a case include distance to the residences, project duration, expected set-up and takedown of the rumble strips and the work zone noise level. Often, rumble strips will not be a significant noise concern compared to the noise generated by construction work activities.

*Standard and Placement*

Portable rumble strips are applied perpendicular to the roadway, from the centerline to the near side of the painted shoulder line, on each approach to the work zone. One set of three rumble strips is placed for each approach. A WD-A-106B sign is installed to warn motorists of the rumble strips. Portable rumble strips shall not be applied on sharp horizontal or vertical curves or within intersections.

Drawings TCS-B-4.7A, TCS-B-4.7B, TCS-B-4.7C, and TCS-B-4.7D shall be used as references when incorporating portable rumble strips into a project's traffic control strategy. When a flagperson or portable traffic signal is used to control and direct traffic, rumble strips shall be placed in advance of them to alert drivers that may not have noticed the approaching traffic control. When rumble strips are applied in high volume or other situations where queue formation and "stop and go" conditions are expected, rumble strips shall be placed well in advance of the work zone, in conjunction with the WD-A-41 sign.

Rumble strip spacing should be varied based on vehicle speed. The spacing between each rumble strip should be 3.0 m for speed limits of 60 km/h or lower, 4.5 m for speed limits between 61 and 90 km/h, and 6.0 m for speed limits higher than 90 km/h. This will ensure that the rumble strips maintain the desirable noise and vibration level.

In some cases, motorists may attempt to bypass the rumble strips by going around on the shoulder. One method to mitigate this issue would be to place delineators on the shoulder to limit the available width. Depending on shoulder width and rumble strip size, another method would be to apply an additional rumble strip across the shoulder.

### *Use*

Portable rumble strips shall be removed when the work zone is no longer active, and there are no hazards present in the travelled way or shoulder.

### **Effective Date**

May 9, 2017

### **Contact**

Elena Yin at (780) 415-4827

Operations, Programming and Planning Branch, Alberta Transportation

### **References**

N/A

### **Approved**

*Original signed  
by Tom Loo*

---

Tom Loo  
Assistant Deputy Minister, Delivery Services Division

## WORK ZONE BULLETIN #6/2017

### Gateway Assemblies

#### Summary

This Bulletin is issued to inform consultants, contractors and department staff of the department's practice for the use of gateway assemblies in work zones. These signs are a new addition to the department's sign catalogue and are intended to enhance motorist awareness by providing a visual cue that indicates they are entering a work zone.

#### Key Changes

##### *Type of Project*

Gateway assemblies should be placed at rural work zone locations that require a speed reduction and have operating speeds of 110 or 100 km/h on the approach. Their use is limited to long duration projects of fourteen days or more on highways within the Level 1 and Level 2 service classifications. Examples of projects where they might be used include roadway grading, widening, or bridge repair.

If used on a carryover project that goes from one construction season to the next, gateway assemblies shall be removed during winter shutdown to allow for snow removal.

##### *Sign Standard and Placement*

Gateway assemblies are composed of three 240 mm x 3600 mm rectangular boards that are mounted to wood posts as shown in Drawing TCS-B-4.8A. One side of the boards has black and orange diagonal stripes and the other has black and white diagonal stripes. The size of the wood posts and any breakaway modifications, if needed, shall follow Chapter H-8 of Alberta Transportation's *Roadside Design Guide*.

Gateway assemblies are applied in pairs, with one assembly placed on each side of the roadway starting at the outer edge of the shoulder. For some highways, there may be a need to increase the distance between the edge of pavement and the assembly to accommodate wide loads. This distance should be determined using site-specific judgment but shall not exceed 2 m from the outer edge of the shoulder.

One pair of gateway assemblies is placed at each entrance to the work zone. The orange and black stripes face entering traffic while the black and white stripes face exiting traffic. The WD-101 sign is mounted to the entrance gateway assembly as shown in Drawing TCS-B-4.8B for undivided highways and Drawing TCS-B-4.8C for divided highways. For divided highways, exiting vehicles will not be faced with a gateway assembly. Gateway assemblies are placed only on the work zone thoroughfare and not on any ramps or intersecting roads.

Gateway assemblies are an enhancement to existing traffic control devices for work zones. Drawing TCS-B-4.8D shall be used as a reference when incorporating gateway assemblies into a project signage strategy.

**Effective Date**

May 9, 2017

**Contact**

Elena Yin at (780) 415-4827

Operations, Programming and Planning Branch, Alberta Transportation

**References**

[“Chapter H-8 Signs, Supports, and Poles”](#) in Alberta Transportation’s [Roadside Design Guide](#)

**Approved**

*Original signed  
by Tom Loo*

---

Tom Loo  
Assistant Deputy Minister, Delivery Services Division

**WORK ZONE BULLETIN #7/2017****“Workers Present When Flashing” Signs****Summary**

This Bulletin is issued to inform consultants, contractors and department staff of the department’s practice for the use of “Workers Present When Flashing” signs.

These signs are a new addition to the department’s sign catalogue and are intended to provide real-time information to motorists about the presence of workers in a construction zone. The signs are equipped with two amber beacons that will flash continuously when workers are present to warn motorists of the increased risk and the higher penalties for speed limit violations.

**Key Changes***Type of Project*

“Workers Present When Flashing” signs should be applied for stationary long duration projects that are five days or more, where workers are present on the road surface including the shoulders, and there is a speed limit reduction. Examples of projects where they might be used include roadway grading, widening, or bridge repair.

*Sign Standard and Placement*

“Workers Present When Flashing” signs are 1200 x 600 mm orange warning signs. Two 200 mm amber LED beacons are attached to the top of the sign as shown in Drawing WD-156. These lights are warning beacons that flash continuously. Flash rate and other operational considerations shall follow “Recommended Practices for Beacons”. The LED specifications shall be in accordance with “Design Bulletin #32/2006”.

“Workers Present When Flashing” signs are placed between the “Maximum Speed Limit Ahead” (RB-5) sign and the “Speed Limit” (RB-1) sign. Drawing TCS-B-4.9 shall be used as a reference when incorporating the “Workers Present When Flashing” sign into the project signage strategy. The sign is placed near the start of the lowest speed limit zone. It is not placed in advance of a transition speed zone.

*Use*

The amber beacons must be turned off when workers are no longer present in order to maintain sign effectiveness. “Speed Fines Double” signs, if applied, shall be covered when the amber beacons are turned off. Use of “Speed Fines Double” signs shall be in accordance with “Work Zone Bulletin #3/2017”. When these signs are applied in conjunction with the “Workers Present When Flashing” sign, the signs will reinforce the

effect that the workers' presence has on speed limit violations.

**Effective Date**

May 9, 2017

**Contact**

Elena Yin at (780) 415-4827

Operations, Programming and Planning Branch, Alberta Transportation

**References**

["Recommended Practices for Beacons"](#)

["Design Bulletin #32/2006"](#)

"Work Zone Bulletin #3/2017"

**Approved**

*Original signed  
by Tom Loo*

---

Tom Loo  
Assistant Deputy Minister, Delivery Services Division



**WORKERS PRESENT WHEN FLASHING**

**WD-156**



LETTERING: 102mm SERIES C

SECTION REFERENCE		
DIMENSIONS (mm)		1200 X 600
ENLARGEMENT FACTOR		8 X
COLOUR		
BACKGROUND	BORDER	MESSAGE / SYMBOL
ORANGE	BLACK	BLACK



## WORK ZONE BULLETIN #8/2017

### Alternatives to Manual Flagging

#### Summary

This Bulletin is issued to inform consultants, contractors and department staff of the department's standards for Automated Flagger Assistance Devices (AFADs) and Portable Traffic Signals. Products that meet these specifications can be used on provincial highways as an alternative to manual flagging, where appropriate for roadway and traffic characteristics. AFADs must also go through the Product Evaluation Process and should not be used until they have been added to Alberta Transportation's Products List.

AFADs mimic the manual flagging process by indicating to motorists to stop or slow down in a work zone. Alberta Transportation allows both "STOP/SLOW" AFADs, which switch between signage to provide traffic control, and Red/Yellow Signal AFADs. They reduce flagger exposure to traffic, as the flagger can shift between the device's two modes from a protected area of the work zone including outside the travelled way.

Portable Traffic Signals control traffic flow using standard traffic signal heads attached to a moveable trailer. These devices do not require a flagger but operate using either fixed time or actuated design.

#### Key Changes

##### Use

The use of AFADs and Portable Traffic Signals shall only occur in work zones where traffic is being limited to a single lane.

##### *Standard for AFADs*

The following requirements apply to both STOP/SLOW AFADs and Red/Yellow Signal AFADs:

- They shall meet the MASH TL-3 standards for crashworthiness.
- They shall be illuminated by overhead lighting if used in hours of darkness.
- They shall be operated by flaggers that have received training for the AFAD. These flaggers shall also be certified in manual flagging in case of device failure.
- Flaggers must remain on the worksite and have complete sightlines to the AFAD(s) that they are operating at all times.

## STOP/SLOW AFADs

STOP/SLOW AFADs use either digital signage or mechanical flipping to display the sign modes of “stop” and “slow”. The sign must be octagonal in shape, with minimum dimensions of 600 mm by 600 mm. The “stop” mode shall display a standard RB-1 sign, with a red background and white lettering. In the “slow” mode, a diamond shaped warning sign with an orange background and the black text “SLOW” shall be displayed. If the AFAD uses a physical sign with mechanical flipping, it shall have a Type IX retro-reflectivity as well as a locking mechanism to ensure it stays in place.

Warning beacon(s) that can display red and yellow lights shall be attached to the top of the sign to further attract motorist attention. The red warning beacon shall face traffic and flash continuously during the “stop” mode. The yellow beacon shall face traffic and flash continuously during the “slow” mode. The beacons must meet the LED specifications outlined in Design Bulletin #32/2006. Flash rate and other operational considerations shall follow “Recommended Practices for Beacons”.

The sign shall be mounted on a support such as a trailer, with the bottom of the sign being at least 1.8 metres from the pavement. STOP/SLOW AFADs shall include a gate arm that descends on the stop mode, with a length that is sufficient to extend at least two-thirds across the closed lane. The gate arm shall have full retro-reflectivity, with alternating red and white stripes that are each 400 mm in length. The gate arm shall have a vertical profile of at least 100 mm.

A “WAIT ON STOP” sign and a “GO ON SLOW” sign may be included with the AFAD to provide motorists with further direction on the expected behavior. These signs are regulatory, with a white background and black lettering.

## Red/Yellow Signal AFADs

Red/Yellow Signal AFADs are composed of a signal head, support structure, and gate. The signal head has two circular lenses with a 300 mm diameter. In the “stop” mode, the top lens will illuminate with a steady red. In the “slow” mode, the other lens shall display flashing yellow. A change interval, displaying steady yellow, shall be provided for at least 3 seconds between the “stop” and “slow” modes. The lenses must meet the LED specifications outlined in “Design Bulletin #32/2006”.

The signal head shall be mounted on a support such as a trailer, with the bottom of the sign being at least 2.1 metres from the pavement. Red/Yellow Signal AFADs shall include a gate arm that descends on the stop mode, with a length that is sufficient to extend at least two-thirds across the closed lane. The gate arm shall have full retro-reflectivity, with alternating red and white stripes that are each 400 mm in length. The gates shall have a vertical profile of at least 100 mm.

A regulatory sign with black lettering and a white background that indicates “STOP HERE ON RED” with an arrow pointing where motorists should stop should be provided in front of or on the AFAD.

## *Standard for Portable Traffic Signals*

Portable traffic signals use conventional traffic signal heads, with three 300 mm diameter lenses for displaying red, yellow, and green lights. They use at least two traffic signal heads, with one mounted overhead and the other mounted to the side of a moveable structure. The battery source must be operable within a temperature range of -40 to 40 degrees Celsius and shall be able to provide sufficient light intensity.

Portable traffic signals have the operational characteristics of regular traffic signals systems. This includes but is not limited to:

- Presence of a conflict monitor to detect system failure, including the activation of simultaneous green on both approaches.
- Programming to switch to flashing red in the event of device malfunction
- Ability to provide notification of low power

### **Effective Date**

Dec. 4, 2017

### **Contact**

Elena Yin at (780) 415-4827

Operations, Programming and Planning Branch, Alberta Transportation

### **References**

[“Design Bulletin #32/2006”](#)

[“Recommended Practices for Beacons”](#)

[Products List](#)

### **Approved**

*Original signed  
by Tom Loo*

---

Tom Loo  
Assistant Deputy Minister, Delivery Services Division

## WORK ZONE BULLETIN #9/2017

### Police Enforcement

#### Summary

When a work zone speed limit is lower than the highway gazetted speed, dangerous situations can be created by motorists who do not comply. The reduced motorist reaction time and the speed differential increase the risk to both workers and other drivers. Enforcement of the work zone speed limit and other traffic laws can significantly improve compliance and safety through the construction zone.

The Alberta government has a contract with the Royal Canadian Mounted Police (RCMP) to complete traffic enforcement on provincial highways. As photo radar is currently prohibited on provincial highways, traffic enforcement is limited by the availability of police officers. Extensive and continuous enforcement at all highway work zone locations is typically not possible. As well, in some cases, enforcement may not have a significant benefit. Due to these factors, police officer use should be reserved for work zones that have obvious operational problems. The purpose of this Bulletin is to describe the situations where enforcement should be considered as well as to provide information on the procedure to request and implement work zone enforcement.

#### Key Changes

##### *Type of Project*

Typically, traffic enforcement in provincial highway work zones takes a reactive approach because of budget and labour constraints. Proper work zone design including appropriate speed limits, barrier protection, and enhanced traffic control devices are the first resource for addressing safety issues. More extensive speed management techniques shall be considered when at least one of the following behaviors is observed:

- Collisions or near misses on the approach to or in the work zone
- Aggressive braking by motorists (for example, at stop conditions or near queues)
- Low compliance to the work zone speed limit
- Worker or public complaints about safety

##### *Procedure for Requesting Traffic Enforcement*

1. Once safety issues have been identified and enforcement determined to be the best option, the Department should contact the RCMP. The Department should provide the RCMP with information about the work zone including the location, work zone design, desired level of enforcement and current safety hazards.

2. The RCMP will advise the extent and duration of enforcement that can be provided based on the availability of their officers.
3. The Department and RCMP will work together to finalize the enforcement type and hours/days of enforcement throughout the project.

An ideal enforcement strategy will address the hazards and issues in the specific work zone. Proper communication between all parties is important to ensure that the best use of available resources is made.

#### *Enforcement Type and Duration*

Examples of work zone enforcement types include stationary enforcement, active enforcement, circulating enforcement, and enforcement packs. When choosing the enforcement type to be used in a work zone, police availability, work zone design, and the effect on compliance should be considered. Work zones are physically constrained and by their nature, may prohibit the safe use of some forms of enforcement. When planning an enforcement strategy, the approximate locations where RCMP will be stationed should be established beforehand.

Duration of enforcement is similarly limited by police availability. Enforcement may be planned to target specific time periods where workers are exposed to greater risk, such as when completing a particular activity, during peak hour traffic, or during nighttime hours. The RCMP will be ultimately responsible for choosing the enforcement type and duration.

#### **Effective Date**

May 9, 2017

#### **Contact**

Elena Yin at (780) 415-4827

Operations, Programming and Planning Branch, Alberta Transportation

#### **References**

N/A

#### **Approved**

*Original signed  
by Tom Loo*

---

Tom Loo  
Assistant Deputy Minister, Delivery Services Division

## WORK ZONE BULLETIN #10/2017

### Lane Rental and Speed Reduction Charges

#### Summary

Lane rental and speed reduction charges may be included in the Special Provisions of a construction or maintenance contract. Lane rental is the practice of charging the contractor for closing a lane to traffic. Speed reduction charges follow the same principle by placing a price on lowering the speed limits in a work zone.

The purpose of these charges is to encourage the contractor to complete a project in a way that limits highway user costs. By introducing a price on lane closures and speed reductions, contractors will place a greater consideration on the delay and inconvenience to highway users when designing their work plan.

#### Key Changes

##### *Type of Project*

Lane rental or speed reduction charges should be considered for projects on high volume highways or other projects that are likely to result in substantial highway user costs. The Project Administrator and Regional Safety Officer should be consulted when determining whether a project falls within these categories.

##### *Lane Rental Charges*

Contractors are typically charged for using a lane by duration and/or distance. The lane rental scheme should be developed based on a project's individual characteristics and its effect on highway users. Time-of-day is a significant consideration as lane closures will have the most negative impact when the highest traffic volume is on the road, such as during peak commuting hours. When statutory holidays are expected to fall during a project, the holiday and its associated weekend may also receive special consideration.

The units of time and distance can vary between projects. When lane rental is included in a project, the contract should identify how rounding will take place when the time/distance falls between increments.

Table 1 below provides an example of how lane rental charges may be applied. **It is provided as a sample only** as lane rental charges should be tailored to specific projects.

**TABLE 1-EXAMPLE OF LANE RENTAL CHARGES BASED ON TIME-OF-DAY**

<b>Time Period</b>	<b>Shoulder Only</b>	<b>1 Lane</b>	<b>2+ Lanes</b>
Monday – Friday 6:00 AM to 9:00 AM & 3:00 PM to 6:00 PM	\$500/km/hour	No Closures Permitted	
Monday – Friday 9:00 AM to 3:00 PM	\$500/km/hour	\$3,000/km/hour	\$5,000/km/hour
Weekend 6:00 PM Friday – 6:00 AM Monday	\$500/km/hour	\$1,000/km/hour	\$1,000/km/hour
Long Weekend *applies and takes precedence over the above time periods only when Monday is a statutory holiday 3:00 PM Friday to 6:00 AM Tuesday	No Closures Permitted		

### *Speed Reduction Charges*

A speed reduction charge introduces a fee when the speed limit is lowered past a specified threshold. Speed reduction charges can be implemented in several ways, either individually or in conjunction with each other. These methods include but are not limited to the ones below:

- Define a straight charge of \$/km/day
- Identify the maximum cumulative kilometres a speed reduction can be in place at any given time over the entire project length. Charge the contractor for every kilometre over the maximum.
- Establish a maximum length that any single reduced speed zone can be in the project. Charge the contractor by kilometre for any reduced speed zone that exceeds the maximum length.
- Identify that a project must be staged in such a way that a stage cannot be started until the prior stage has been completed to a point that the gazetted speed can be re-established.

When both lane rental and speed reduction charges are used on a project, the same pricing scheme may be applied.

### **Effective Date**

May 9, 2017

### **Contact**

Elena Yin at (780) 415-4827

Operations, Programming and Planning Branch, Alberta Transportation

### **References**

N/A



**Approved**

*Original signed  
by Tom Loo*

---

Tom Loo  
Assistant Deputy Minister, Delivery Services Division

## WORK ZONE BULLETIN #11/2017

### Smart Work Zones

#### Summary

Smart Work Zones apply Intelligent Transportation Systems (ITS) to provide real-time information and warnings to motorists prior to or within the work zone. Through the integrated use of sensors, computers and communication channels, Smart Work Zones can reduce delays and improve safety on provincial highways.

Alberta Transportation already regularly uses several forms of ITS technology for work zones. Driver (Speed) Feedback signs, as addressed in Work Zone Bulletin #4, encourage drivers to self-correct by informing them of their speed in relation to the posted speed limit. On the communication side, 511Alberta is a web-based application that assists drivers with their route planning by identifying work zone locations and characteristics.

The purpose of this bulletin is to recommend additional technologies and identify the scenarios where they are best applied. The Key Changes below apply only to these new technologies that are being introduced in this bulletin. The integration of these Smart Work Zone technologies is expected to have several benefits for work zones including:

- Improved traffic flow through the work zone
- Enhanced safety for motorists and workers
- Better motorist response to hazards
- Reduced driver frustration

#### Key Changes

##### *Type of Project*

The use of Smart Work Zone technologies shall be limited to high volume provincial highways that are located in urban and urban fringe areas. At these locations, Smart Work Zones will have the most benefit due to the higher likelihood of congestion and the availability of alternate routes. Generally, high volume can be defined as equal to or greater than 20,000 vehicles per day. The benefits of Smart Work Zones will start to be substantial when the traffic volume reaches or exceeds 50,000 vehicles per day.

The Project Sponsor shall be ultimately responsible for determining whether a work zone should utilize Smart Work Zone applications. The Project Sponsor shall consider which type(s) of ITS technologies are most beneficial based on the recommendations below.

Where the work zone falls near or within a municipality, the municipality must be consulted in case of impacts on local roads. If Smart Work Zone technologies will be included on a project, they must be incorporated within the Special Provisions.

### *Smart Work Zone Applications*

Table 1 provides Smart Work Zone applications that are recommended for use on provincial highways. The Project Sponsor may choose to apply one or multiple technologies. By providing information that reflects current conditions, motorists can make decisions that can enhance the safety, travel time or capacity of the highway. The primary method for communicating the information is through Variable Message Signs (VMS) that are posted at the highway work zone location. However, the Project Sponsor may also want to consider having a communication strategy that relays the real-time information through Traveler Advisory (TA) methods. TA methods include any existing communication channels that are not at the worksite such as 511 Alberta, commercial radio stations and other online media.

**Table 1: Recommended Smart Work Zone Applications**

<i>Application</i>	<i>Display</i>	<i>Definition</i>	<i>Conditions for Use</i>
<b>Travel Time and delay estimation</b>	VMS TA	Provides motorists with an estimate of the travel time and delays along the highway.	<ul style="list-style-type: none"> <li>• Congestion is an issue</li> <li>• Delays/travel times are variable</li> </ul>
<b>Alternate route advisory</b>	VMS TA	Suggests an alternate route for motorists. May provide motorists with an estimate of the travel time through the work zone compared to the travel time through the alternate route	<ul style="list-style-type: none"> <li>• Congestion is an issue</li> <li>• An alternate route is available</li> </ul>
<b>Dynamic Merging Strategies</b>	VMS	Displays messages indicating whether a zipper or early merge should be used depending on current traffic volumes.	<ul style="list-style-type: none"> <li>• The highway traffic volume fluctuates significantly throughout the day, such that the zipper merge is only beneficial in a few hours of the work period.</li> <li>• Refer to Work Zone Bulletin #2 for the use of the zipper merge strategy.</li> </ul>
<b>Queue Warning</b>	VMS	Warns motorists of the need to slow down due to an approaching queue	<ul style="list-style-type: none"> <li>• Congestion is an issue.</li> <li>• There is a high speed on the approach.</li> </ul>

*Adapted from MassDOT Smart Work Zone Design Standards*

### *Other considerations*

Smart Work Zone applications are not limited to the ones outlined in Table 1. There are many emerging technologies that may be applicable to work zones. The use of such technologies may be considered if it is likely to provide significant benefit to the project.

One example of an ITS solution that may be considered for work zones in the future is Variable Speed Limit (VSL) signs. These signs can be used to deal with congestion by displaying regulatory or advisory speeds that can be changed depending on current traffic conditions.

### **Effective Date**

September 11<sup>th</sup>, 2017

### **Contact**

Elena Yin at (780) 415-4827

Operations, Programming and Planning Branch, Alberta Transportation

### **References**

Work Zone Bulletin #4

[511Alberta](#)

### **Approved**

*Original signed*

*by Tom Loo*

---

Tom Loo  
Assistant Deputy Minister, Delivery Services Division

**WORK ZONE BULLETIN #12/2018****Digital Speed Limit Signs****Summary**

Construction activities on provincial highways pose a challenge to worker and motorist safety due to the high travelling speeds on the facility. Temporary speed reductions are considered warranted when the work activities create significant hazards in the roadway environment or put workers into high-risk situations. When neither condition exists, motorist compliance will be low unless there is extensive police enforcement. For this reason, it is critical to only maintain speed reductions during time periods and along roadway segments where the hazards and/or risks to workers exist.

Currently, contractors are required to cover or remove speed limit signs when the reduced speed limit is no longer warranted. This makes driver compliance more likely and allows the roadway to operate at a higher capacity. However, when a work zone sees frequent speed limit changes, covering or removing the signs may become an onerous task. In some cases, speed limit signs that are inappropriate for roadway conditions have been left up on provincial highways.

Digital Speed Limit signs use an electronic message board to display the regulatory speed limit within the work zone. The speed limits displayed on the board can be changed remotely when the work activity or work zone design changes. This is expected to result in several benefits:

- Increased flexibility in work zone speed limit changes
- Improved contractor compliance in displaying the appropriate speed limit
- Reduced worker exposure during work zone set-up and take-down
- Fewer public complaints about unsuitable speed limits

Digital Speed Limit signs should not be confused with Variable Speed Limit signs, which are an ITS application that is discussed in Work Zone Bulletin #11. Digital Speed Limit signs do not change the existing practice of setting work zone speed limits. They simply provide an alternative method of displaying these speed limits.

**Key Changes***Type of Project*

Digital Speed Limit signs should be considered for projects where the work zone will frequently warrant changes in the posted speed limits based on Section 9.1.3 in Alberta Transportation's *Traffic Accommodation in Work Zones*. Their use should be limited to

stationary, long duration projects where the gazetted highway speed is 100 or 110 km/h. The project duration must be long enough to offset the greater expense and work required to set up the Digital Speed Limit signs. This is likely to be a project that is two months or greater. The Project Sponsor is responsible to determine whether a project would benefit from Digital Speed Limit signs.

### *Sign Standard and Placement*

Digital Speed Limit signs shall resemble the static sign that they are replacing as shown in Drawing TCS-B-4.10. They are regulatory signs with digital and static components that have a black message on a white background. For two-lane highways, the sign is 750 mm by 900 mm, and for multi-lane highways, the sign is 900 mm by 1200 mm. All static sections of the sign shall have a retroreflectivity of ASTM Type III or Type IV. The digital component of the sign shall have sufficient brightness to be visible during hours of daylight and darkness. Digital Speed Limit signs must have the capability to be changed remotely.

When Digital Speed Limit signs are incorporated into a signage strategy, both “Maximum Speed (RB-1) signs and “Maximum Speed Ahead” (RB-5) signs shall be digital. This includes the signs used for the work zone speed zone and the transition speed zone. Placement of Digital Speed Limit signs shall follow the same scheme as their corresponding static sign.

### *Use*

Prior to the start of a construction project, the Project Manager (usually, the consultant) shall fill out an “Order Fixing Maximum Speed Limits”, indicating the expected speed limits that will be used in the construction project. The Project Manager shall also note that Digital Speed Limit signs are being used in place of static signs. Throughout the project, the contractor is responsible for maintaining a daily log of speed changes that includes the time, posted speed limit and physical locations of the signs. Record-keeping is critical for upholding speed enforcement as well as providing information if a collision occurs.

### **Effective Date**

April 26, 2018

### **Contact**

Elena Yin at (780) 415-4827

Operations, Programming and Planning Branch, Alberta Transportation

### **References**

Work Zone Bulletin #11

[Traffic Accommodation in Work Zones](#)

**Approved**

*Original signed  
by Tom Loo*

---

Tom Loo  
Assistant Deputy Minister, Delivery Services Division

## TWO-LANE HIGHWAY

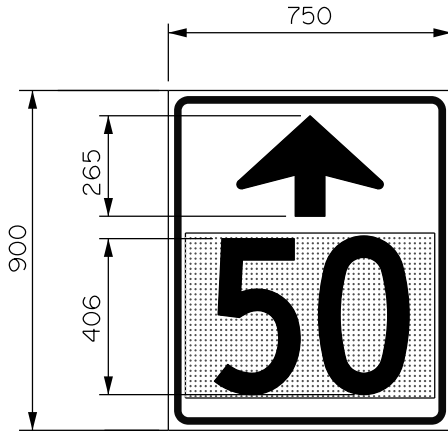

RB-5

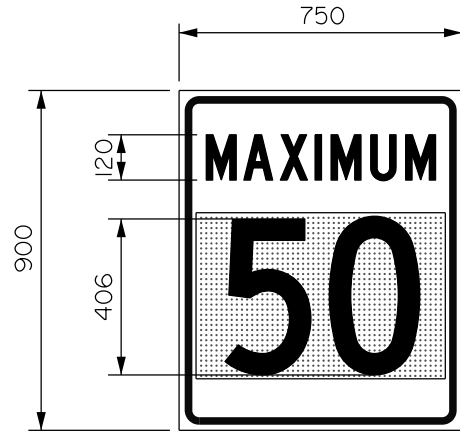

RB-1

## MULTI-LANE HIGHWAY

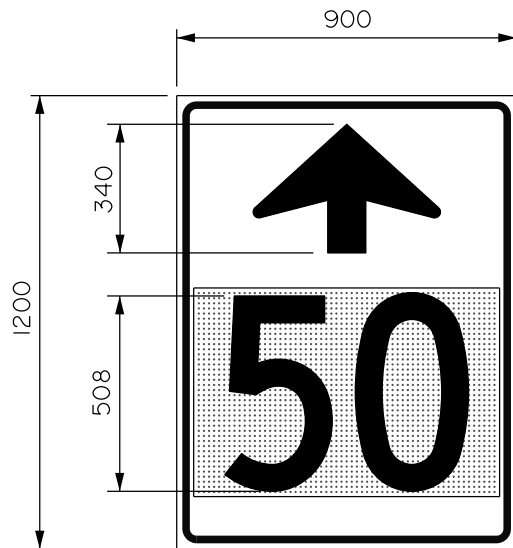

RB-5

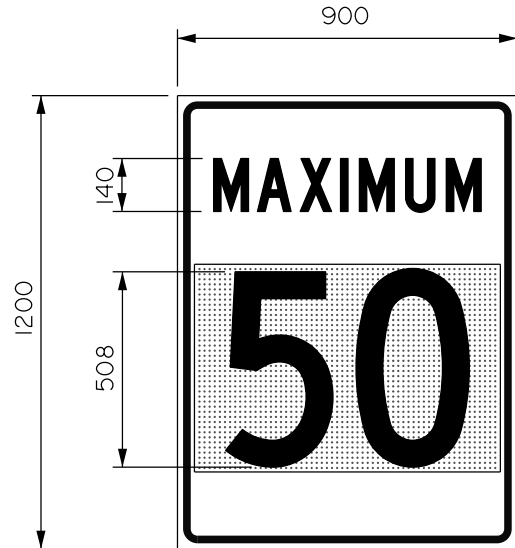

RB-1

LETTERING: SERIES C

BORDER: 20mm with 38mm corner radius.

MARGINS: 15mm

STATIC SIGN COLOUR:  
Message-white, Border-black, Background-white

DIGITAL BOARD COLOUR:  
Number-black, Background-white

STATIC SIGN FACE:  
ASTM Type III or IV High intensity retro-reflective sheeting

Note: All dimensions are in mm unless otherwise specified.

No.	REVISIONS	BY	DATE
Approved:			
Assistant Deputy Minister, Delivery Services Division			
Date:	JULY 2017		
DIGITAL SPEED LIMITS			
Prepared By: S.L.	Checked By: N.C.	Scale: N.T.S.	Dwg No.: TCS-B-4.10



# **APPENDIX C**

## **SIGN SCHEDULE AND SHEETING REQUIREMENTS**

# **SIGN SCHEDULE**

**NOTES:**

1. Sign size, shape, symbol and colour are to be in accordance with the latest edition of the Uniform Traffic Control Devices for Canada Manual and applicable Alberta Transportation (AT) standards. Where there is any discrepancy between the MUTCD Manual and the AT standards, the latter shall prevail.
2. For the initial WD-101 sign, 1200 x 1200 is used on the main alignment and 750 x 750 is used on intersecting roads.















**2.0 SIGN SHEETING REQUIREMENTS**

The orange portion of all signs, barricades and other Traffic Control Devices shall be fully reflectorized using High Brightness, Retroreflective, Non-Metalized, Prismatic Sheeting Material which incorporates durable, transparent, fluorescent pigment and meets the following requirements:

<b>BRIGHTNESS REQUIREMENTS (90° Rotation Angle)</b>		
Observation Angle	Entrance Angle	Orange
0.2	-4	200
0.2	30	92
0.5	-4	80
0.5	30	50

A Minimum Coefficient of Retroreflection (RA)  $cd/fc/ft^2$  ( $cd \cdot lx^{-1} \cdot m$ )

## SIGN SCHEDULE

	SIGN NO.	MESSAGE OR DESCRIPTION	SIZE (mm x mm)			LETTER HEIGHT AND SERIES NO.	COLOUR	
			RURAL	URBAN			MESSAGE	BACK-GROUND
				High Speed/ High Volume	Low Speed/ Low Volume			
	IB-2	Alberta Route Marker	450 x 600	450 x 600	450 x 600	Pattern Available	Black	White
	IB-8-TL	Alberta Direction Tab (Left)	450 x 300	450 x 300	450 x 300	Symbol	Black	White
	IB-8-TR	Alberta Direction Tab (Right)	450 x 300	450 x 300	450 x 300	Symbol	Black	White
	ID-503	Speed Double Fines	600 x 600	600 x 600	600 x 600	Symbol	Black	White
	ID-503A	Double Fines Begins Tab	600 x 300	600 x 300	600 x 300	Symbol	White	Black
	ID-503B	Double Fines Ends Tab	600 x 300	600 x 300	600 x 300	Symbol	White	Black
	IF-205	Exit	1450x1200x1000	1450x1200x1000	N/A		White	Green
	RA-1	Stop	600 x 600	900 x 900	600 x 600	255 mm "C"	White	Red
	RB-1	Maximum Speed Content Variable	600 x 750	750 x 900	600 x 750	#1 - 100 mm "C", #2 - 300 mm Variable	Black	White
	RB-5	Maximum Speed Ahead Content Variable	600 x 750	750 x 900	600 x 750	#1 - 100 mm "C", #2 - 300 mm Variable	Black	White
	RB-24A	Two-Way Traffic	600 x 750	750 x 900	600 x 750	Symbol	Black	White
	RB-31	Do Not Pass	600 x 600	750 x 750	600 x 600	Symbol	Red, Black	White
	WA-9	Chevron Alignment	600 x 750	600 x 750	600 x 750		Black	Yellow
	WA-16-L	Merging Traffic (Left)	900 x 900	900 x 900	900 x 900		Black	Yellow
	WA-16-R	Merging Traffic (Right)	900 x 900	900 x 900	900 x 900		Black	Yellow

## SIGN SCHEDULE

	SIGN NO.	MESSAGE OR DESCRIPTION	SIZE (mm x mm)			LETTER HEIGHT AND SERIES NO.	COLOUR	
			RURAL	URBAN			MESSAGE	BACK-GROUND
				High Speed/ High Volume	Low Speed/ Low Volume			
	WA-31	Divided Highway Begins	900 x 900	900 x 900	900 x 900	Symbol	Black	Yellow
	WA-31-T	Divided Highway Begins Tab	600 x 300	600 x 300	600 x 300	150 mm "C"	Black	Yellow
	WA-32	Divided Highway Ends	900 x 900	900 x 900	900 x 900	Symbol	Black	Yellow
	WA-112-L	Added Lane (Left)	900 x 900	900 x 900	900 x 900		Black	Yellow
	WA-112-R	Added Lane (Right)	900 x 900	900 x 900	900 x 900		Black	Yellow
	WB-1	Stop Ahead	750 x 750	750 x 750	750 x 750	Symbol	Red, Black	Yellow
	WD-101	Construction Ahead	750 x 750 1200 x 1200	1200 x 1200	1200 x 1200	#1 - 150 mm "C", 180 mm "C", #2 - 150 mm "C"	Black	Orange
	WD-101B	Bridge Construction Ahead	1200 x 1200	1200 x 1200	900 x 900	#1 - 150 mm "C", 180 mm "C", #2 - 150 mm "C"	Black	Orange
	WD-101C	Utility Construction	900 x 900	1200 x 1200	900 x 900	#1 - 150 mm "C", 180 mm "C", #2 - 150 mm "C"	Black	Orange
	WD-102	Begin Detour 300 m	900 x 900	900 x 900	900 x 900	#1 & #2 - 150 mm "C", #3 - 125 mm "E"	Black	Orange
	WD-103	Detour Next _ km	1200 x 600	1200 x 600	1200 x 600	150 mm "C"	Black	Orange
	WD-104	Barricade Ahead	900 x 900	1200 x 1200	900 x 900	#1 - 150 mm "C", #2 - 125 mm "C"	Black	Orange
	WD-105	Bridge Inspection	750 x 750	750 x 750	750 x 750	#1 - 150 mm "C", #2 - 150 mm "C"	Black	Orange
	WD-106	One Lane Traffic	750 x 750	900 x 900	750 x 750	#1 - 150 mm "C", #2 - 150 mm "C"	Black	Orange
	WD- 111	Be Prepared To Stop	750 x 750	750 x 750	750 x 750	#1, #3, #4 - 100 mm "E", 42 - 100 mm "D"	Black	Orange

## SIGN SCHEDULE

	SIGN NO.	MESSAGE OR DESCRIPTION	SIZE (mm x mm)			LETTER HEIGHT AND SERIES NO.	COLOUR	
			RURAL	URBAN			MESSAGE	BACK-GROUND
				High Speed/ High Volume	Low Speed/ Low Volume			
	WD-116-1L	Barricade (Left)	2440 x 250	2440 x 250	2440 x 250	See Plan TCS-B-4.1	Black	Orange
	WD-116-1R	Barricade (Right)	2440 x 250	2440 x 250	2440 x 250	See Plan TCS-B-4.1	Black	Orange
	WD-116-2	Road Closed Barricade	2440 x 250	2440 x 250	2440 x 250	See Plan TCS-B-4.1	Black	Orange
	WD-116-3	Bridge Out Barricade	2440 x 250	2440 x 250	2440 x 250	See Plan TCS-B-4.1	Black	Orange
	WD-116-4L	Light Duty (Type 1) Barricade	N/A	N/A	760 x 300		Black	Orange
	WD-116-4R	Light Duty (Type 1) Barricade	N/A	N/A	760 x 300		Black	Orange
	WD-116-5	Barricade Arrow	615 x 230	615 x 230	615 x 230	See Plan TCS-B-4.1	White	Black
	WD- 150	Loose Gravel	750 x 750	900 x 900	750 x 750	#1 - 125 mm "D", #2 - 125 mm "D"	Black	Orange
	WD- 151	Windrow	750 x 750	900 x 900	750 x 750	#1 - 125 mm "D", #2 - 125 mm "D"	Black	Orange
	WD- 152	Temporary Hazard Marker	300 x 300	300 x 300	300 x 300		Red	Red
	WD-154	End Construction	1200 x 600	1200 x 600	1200 x 600	Pattern Available	Black	Orange
	WD-157	Slow Fresh Oil	750 x 750	900 x 900	750 x 750	125 mm "D"	Black	Orange
	WD-158	Testing Crews Next 5 km	900 x 900	1200 x 1200	900 x 900		Black	Orange
	WD-169	Loose Chips Please Slow Down	1200 x 750	1200 x 750	1200 x 750	Pattern Available	Black	Orange
	WD-170B	Bridge Construction 3 km	1200 x 1200	1200 x 1200	1200 x 1200	#1 -180 mm "C", #2 -180 mm "E"	Black	Orange
	WD-171	Follow In Convoy Do Not Pass	750 x 900	750 x 900	750 x 900	Pattern Available	Black	Orange

## SIGN SCHEDULE

	SIGN NO.	MESSAGE OR DESCRIPTION	SIZE (mm x mm)			LETTER HEIGHT AND SERIES NO.	COLOUR	
			RURAL	URBAN			MESSAGE	BACK-GROUND
				High Speed/ High Volume	Low Speed/ Low Volume			
	WD-172	Follow Pilot Vehicle	600 x 750	750 x 900	600 x 750	Pattern Available	Black	Orange
	WD-173	Pilot Vehicle Do Not Pass	1650 x 450	1650 x 450	1650 x 450	Pattern Available	Black	Orange
	WD-174	Maximum — Loose Chips	600 x 1200	900 x 1800	600 x 1200	Pattern Available	Black	White, Orange
	WD-175	Smoke Ahead	750 x 750	900 x 900	750 x 750		Black	Orange
	WD-179	Traffic Survey Ahead	750 x 750	900 x 900	750 x 750		Black	Orange
	WD-182	New Sign	750 x 750	900 x 900	750 x 750		Red and White	Fluorescent Yellow
	WD-182-T	Traffic Control Tab	600 x 300	600 x 300	600 x 300		Black	Yellow
	WD-182A-T	Signal Tab	600 x 300	600 x 300	600 x 300		Black	Yellow
	WD-182B-T	Timing Tab	600 x 300	600 x 300	600 x 300		Black	Yellow
	WD-182C-T	Phasing Tab	600 x 300	600 x 300	600 x 300		Black	Yellow
	WD-182D-T	Roundabout Tab	600 x 300	600 x 300	600 x 300		Black	Yellow
	WD-184	Testing Crew Ahead	900 x 900	900 x 900	900 x 900		Black	Orange
	WD-187	No Centre Line	750 x 750	900 x 900	750 x 750		Black	Orange
	WD-188	Ramp Exit	750 x 750	900 x 900	750 x 750		Black	Orange
	WD-189	Line Painting Ahead	750 x 750	900 x 900	750 x 750		Black	Orange
	WD-190	Wet Paint	750 x 750	900 x 900	750 x 750		Black	Orange

## SIGN SCHEDULE

	SIGN NO.	MESSAGE OR DESCRIPTION	SIZE (mm x mm)			LETTER HEIGHT AND SERIES NO.	COLOUR	
			RURAL	URBAN			MESSAGE	BACK-GROUND
				High Speed/ High Volume	Low Speed/ Low Volume			
	WD-191	Road Grading 3 km	750 x 750	750 x 750	750 x 750		Black	Orange
	WD-192	Road Construction Next __ km	1200 x 900	1200 x 900	1200 x 900	Pattern Available, 160mm "C"	Black	Orange
	WD-193	Grading Next 3 km	1200 x 1200	1200 x 1200	1200 x 1200	Symbol	Black	Orange
	WD-194	To Oncoming Traffic	900 x 750	900 x 750	900 x 750		Black	Orange
	WD-196A	Zipper Merge Ahead	900 x 1050	900 x 1050	900 x 1050		Black	Orange
	WD-196B	Zipper Merge Ahead (Optional)	900 x 900	900 x 900	900 x 900		Black	Orange
	WD-197	Use Both Lanes	900 x 1050	900 x 1050	900 x 1050		Black	Orange
	WD-198	Alternate Merge xxm Ahead	1200 x 1350	1200 x 1350	1200 x 1350		Black	Orange
	WD-199-L	Merge Left	900 x 900	900 x 900	900 x 900		Black	Orange
	WD-199-R	Merge Right	900 x 900	900 x 900	900 x 900		Black	Orange
	WD-203	Emergency Scene Ahead	900 x 900	900 x 900	900 x 900		Black	Pink
	WD-201	Construction Advisory	2440 x 1530	2440 x 1530	2440 x 1530		Black	Orange
	WD-202	Seal Coat Construction Advisory	2440 x 1530	2440 x 1530	2440 x 1530		Black	Orange
	WD-A-1-L	Turn (Left)	750 x 750	750 x 750	750 x 750	Symbol	Black	Orange
	WD-A-1-R	Turn (Right)	750 x 750	750 x 750	750 x 750	Symbol	Black	Orange
	WD-A-5-L	Reverse Curve (Left)	750 x 750	900 x 900	750 x 750	Symbol	Black	Orange

## SIGN SCHEDULE



	SIGN NO.	MESSAGE OR DESCRIPTION	SIZE (mm x mm)			LETTER HEIGHT AND SERIES NO.	COLOUR	
			RURAL	URBAN			MESSAGE	BACK-GROUND
				High Speed/ High Volume	Low Speed/ Low Volume			
	WD-A-5-R	Reverse Curve (Right)	750 x 750	900 x 900	750 x 750	Symbol	Black	Orange
	WD-A-7	Advisory Speed	600 x 600	600 x 600	600 x 600	255 mm "E"	Black	Orange
	WD-A-10	Detour Ahead	750 x 750	900 x 900	750 x 750		Black	Orange
	WD-A-21	Traffic Control Person Ahead	750 x 750	900 x 900	750 x 750		Black	Orange
	WD-A-22	Bump	750 x 750	900 x 900	750 x 750	Symbol	Black	Orange
	WD-A-23-R	Roadway Narrows (Right)	750 x 750	900 x 900	750 x 750	Symbol	Black	Orange
	WD-A-23-L	Roadway Narrows (Left)	750 x 750	900 x 900	750 x 750	Symbol	Black	Orange
	WD-A-24	Narrow Structure	750 x 750	900 x 900	750 x 750	Symbol	Black	Orange
	WD-A-31	Divided Highway Begins	900 x 900	900 x 900	900 x 900	Symbol	Black	Orange
	WD-A-32	Divided Highway Ends	900 x 900	900 x 900	900 x 900	Symbol	Black	Orange
	WD-A-33-L	Road Narrows - Left Lane Ends	750 x 750	900 x 900	750 x 750	Symbol	Black	Orange
	WD-A-33-R	Road Narrows - Right Lane Ends	750 x 750	900 x 900	750 x 750	Symbol	Black	Orange
	WD-A-33X-L	Road Narrows - Left Lane Ends	750 x 750	900 x 900	750 x 750	Symbol	Black	Orange
	WD-A-33X-R	Road Narrows - Right Lane Ends	750 x 750	900 x 900	750 x 750	Symbol	Black	Orange
	WD-A-41	Road Work	750 x 750	900 x 900	750 x 750	Symbol	Black	Orange
	WD-A-41-T	Road Work Tab	600 x 450	600 x 450	600 x 450	Symbol	Black	Orange



## SIGN SCHEDULE

	SIGN NO.	MESSAGE OR DESCRIPTION	SIZE (mm x mm)			LETTER HEIGHT AND SERIES NO.	COLOUR	
			RURAL	URBAN			MESSAGE	BACK-GROUND
				High Speed/ High Volume	Low Speed/ Low Volume			
	WD-A-43-L	Roadside Diversion (Left)	750 x 750	900 x 900	750 x 750	Symbol	Black	Orange
	WD-A-43-R	Roadside Diversion (Right)	750 x 750	900 x 900	750 x 750	Symbol	Black	Orange
	WD-A-44-T	Detour Tab	450 x 300	450 x 300	450 x 300	150 mm "C"	Black	Orange
	WD-A-46	Survey Crew Ahead	750 x 750	900 x 900	750 x 750	Symbol	Black	Orange
	WD-A-48-L	Truck Entrance (Left)	750 x 750	900 x 900	750 x 750	Symbol	Black	Orange
	WD-A-48-R	Truck Entrance (Right)	750 x 750	900 x 900	750 x 750	Symbol	Black	Orange
	WD-A-49	Pavement Drop-off	750 x 750	900 x 900	750 x 750	Symbol	Black	Orange
	WD-A-51-L	Roadside Diversion (Left) (Two Lanes)	750 x 750	900 x 900	750 x 750	Symbol	Black	Orange
	WD-A-51-R	Roadside Diversion (Right) (Two Lanes)	750 x 750	900 x 900	750 x 750	Symbol	Black	Orange
	WD-A-100	Sharp Shoulder	750 x 750	900 x 900	750 x 750	150 mm "C"	Black	Orange
	WD-A-105-R	Hazard Marker - Keep Left	300 x 900	300 x 900	300 x 900		Black	Orange
	WD-A-105-L	Hazard Marker - Keep Right	300 x 900	300 x 900	300 x 900		Black	Orange
	WD-A-111	Grooved Pavement	750 x 750	900 x 900	750 x 750	Symbol	Black	Orange
	WD-A-111-T	Grooved Pavement Tab	600 x 300	600 x 300	600 x 300	150 mm "C"	Black	Orange
	WD-A-120	Slow Moving Vehicle	510 x 510 x 510	510 x 510 x 510	510 x 510 x 510	Symbol	Orange	Red
	WD-B-3	Two-Way Traffic Ahead	750 x 750	900 x 900	750 x 750	Symbol	Black	Orange

## SIGN SCHEDULE

	SIGN NO.	MESSAGE OR DESCRIPTION	SIZE (mm x mm)			LETTER HEIGHT AND SERIES NO.	COLOUR	
			RURAL	URBAN			MESSAGE	BACK-GROUND
				High Speed/ High Volume	Low Speed/ Low Volume			
	WD-B-4	Traffic Signals Ahead	900 x 900	900 x 900	900 x 900	Symbol	Red, Yellow, Green, Black	Orange
	WD-B-4-T	Structure Width Tab (__ m)	600 x 300	600 x 300	600 x 300		Black	Orange
	WD-T	Distance Tab (__ km)	600 x 300	600 x 300	600 x 300		Black	Orange

**APPENDIX D**  
**SAMPLE FORMS**



## TRAFFIC ACCOMMODATION STRATEGY COMPONENT CHECKLIST

	YES	NO	N/A
<b>1. Is the Project Identified?</b> - contract number - highway number - project limits to be shown	<input type="checkbox"/>	<input type="checkbox"/>	<input type="checkbox"/>
<b>2. Is the Project “Scope of Work” Identified?</b>	<input type="checkbox"/>	<input type="checkbox"/>	<input type="checkbox"/>
<b>3. Is the Contractor Identified?</b>	<input type="checkbox"/>	<input type="checkbox"/>	<input type="checkbox"/>
<b>4. Are Sub Contractors Identified?</b> - contact names/phone numbers - assorted tasks	<input type="checkbox"/>	<input type="checkbox"/>	<input type="checkbox"/>
<b>5. Is the Schedule Identified?</b> - date of commencement/completion - milestone dates interim stage of completion	<input type="checkbox"/>	<input type="checkbox"/>	<input type="checkbox"/>
<b>6. Is the Process for Sign Installation/Covering/Removal Identified?</b> - 2 lane highways - 4 lane highways	<input type="checkbox"/>	<input type="checkbox"/>	<input type="checkbox"/>
<b>7. Will the Project be Pre-Signed?</b> - strategy for covering/monitoring signs	<input type="checkbox"/>	<input type="checkbox"/>	<input type="checkbox"/>
<b>8. Is the Type of Sign Supports Identified?</b> - posts/portables/windmaster/etc.	<input type="checkbox"/>	<input type="checkbox"/>	<input type="checkbox"/>
<b>9. Are the Sign Height Requirements Identified?</b> - long duration signs - short duration signs	<input type="checkbox"/>	<input type="checkbox"/>	<input type="checkbox"/>
<b>10. Are Responsibilities for TCS Identified?</b> - name(s) of on-site designate and contact numbers - monitoring of TCD’s during inactive periods	<input type="checkbox"/>	<input type="checkbox"/>	<input type="checkbox"/>
<b>11. Are Day/Night Procedures Established?</b>	<input type="checkbox"/>	<input type="checkbox"/>	<input type="checkbox"/>
<b>12. Is Accommodating Vehicles around Tack Coat &amp; Non-Standard Lane Widths Identified?</b>	<input type="checkbox"/>	<input type="checkbox"/>	<input type="checkbox"/>
<b>13. Are Special User Issues Identified?</b> - over dimensional loads, emergency vehicles, etc.	<input type="checkbox"/>	<input type="checkbox"/>	<input type="checkbox"/>
<b>14. Are Non Typical Conditions Identified?</b> - did contractor address items from S.P.’s?	<input type="checkbox"/>	<input type="checkbox"/>	<input type="checkbox"/>
<b>15. Is Work Staging Identified?</b> - template for each stage - no situations missing	<input type="checkbox"/>	<input type="checkbox"/>	<input type="checkbox"/>

- |   |                          |                          |                          |
|---|--------------------------|--------------------------|--------------------------|
| <p><b>16. Are Detour(s) Identified?</b><br/> - customized drawings</p>  | <input type="checkbox"/> | <input type="checkbox"/> | <input type="checkbox"/> |
| <p><b>17. Are Drawings Submitted?</b><br/> - all activities</p>   | <input type="checkbox"/> | <input type="checkbox"/> | <input type="checkbox"/> |
| <p><b>18. Is the Parking of Vehicles/Equipment Been Identified?</b><br/> - during working hours<br/> - during non-working hours</p>                             | <input type="checkbox"/> | <input type="checkbox"/> | <input type="checkbox"/> |
| <p><b>19. Is the Requirements for Flagpersons Been Identified?</b><br/> - certifying agency<br/> - protective clothing<br/> - certificate readily available</p> | <input type="checkbox"/> | <input type="checkbox"/> | <input type="checkbox"/> |
| <p><b>20. Is the Procedure for Centreline Spotting Been Identified?</b><br/> - Strategy for the protection of workers</p>                                       | <input type="checkbox"/> | <input type="checkbox"/> | <input type="checkbox"/> |
| <p><b>21. Speed Limits Identified?</b><br/> - all activities<br/> - non active periods<br/> - distinct phase breaks</p>   | <input type="checkbox"/> | <input type="checkbox"/> | <input type="checkbox"/> |
| <p><b>22. Is the Use of Pilot Vehicles Identified?</b></p>  | <input type="checkbox"/> | <input type="checkbox"/> | <input type="checkbox"/> |
| <p><b>23. Is the Requirement for the Daily Sign Log Been Identified?</b><br/> - include timeline for submission of info to consultant</p>                       | <input type="checkbox"/> | <input type="checkbox"/> | <input type="checkbox"/> |
| <p><b>24. Is the Reporting of Accidents Been Identified?</b></p>  | <input type="checkbox"/> | <input type="checkbox"/> | <input type="checkbox"/> |
| <p><b>25. Is the Haul Route(s) Identified?</b></p>  | <input type="checkbox"/> | <input type="checkbox"/> | <input type="checkbox"/> |
| <p><b>26. Is the Process For Truck Turning Movements Within the Work Area/Zone Identified?</b></p>  | <input type="checkbox"/> | <input type="checkbox"/> | <input type="checkbox"/> |
| <p><b>27. Emergency Response Strategy?</b><br/> - names/contact numbers<br/> - arrangement with emergency responders</p>  | <input type="checkbox"/> | <input type="checkbox"/> | <input type="checkbox"/> |

**NOTES**

Strategy must conform to the Traffic Accommodation In Work Zones Manual (current edition)  
Not an all-inclusive list. Additional information may have to be considered and provided on a project by project basis.